Bu katalogtaki tüm telif hakkı Albatır Endüstri A.Ş. aittir. Yazılı izin olmadan tam yada kısmen kopyalanamaz veya çoğaltılamaz. Tüm detaylarda ve teknik konularda değişiklik yapma hakkı saklıdır. Ürünlerimiz faydalı model ve endüstriyel tasarım belgeleri ile tescillenmiştir.

All rights in this catalog reserved by Albatır Endüstri A.Ş. no part of this publication may be reproduced or copied without any written permission. All technical details are subject to change. Our products are registered with utility model and industrial design documentations.

Katalogtaki ürün sayfalarında verilen teknik ölçüler bağlayıcı değildir. Önerilen kurulum ölçüleridir. Albatır ürün özelliklerinde haber vermeden değişiklik yapabilir.

Technical dimensions are not binding given in the catalog. They are recommended installation sizes. Albatır can make modification on the products features without any notice.

Tipografik hatalardan firmamız sorumlu değildir.
Our company is not responsible for typographic fault.

Hakkımızda

ABOUT US



Hakkımızda

Türkiye'nin önde gelen sürgü sistem markası Albatür Endüstri A.Ş.'nin yolculuğu 1976 yılında Bursa'da başlamıştır.

Üretici kimliği ile farklı sektörlerde hizmet eden firmamız, 2003 yılından bu yana odak noktasını sürgülü katlanır kapı ve kapak sistemleri olarak belirlemiştir.

45 yıllık üretim deneyimine sahip Albatür, ürünlerini Bursa'nın Nilüfer ilçesinde 11.000 m² fabrikasında doğaya saygılı modern tesislerinde üretmektedir.

Üretimi gerçekleştirilen tüm mobilya donanımlarının; ar-ge, tasarım, kalıp, sac şekillendirme, eksantrik pres, hidrolik pres, plastik enjeksiyon, cnc talaşlı imalat, elektrostatik fırın boya, yağ boya, alüminyum işleme makinaları, montaj ve robot otomasyonları kendi bünyesinde bulunmaktadır. Üretim süreçlerimiz alanında uzman mühendislerimizin kontrolünde gerçekleşmektedir.

Albatür, geliştirdiği ürünlerle yaşam alanlarını büyütmenin yanı sıra, yenilikçi ve teknolojik çözümlerle en üst seviyede müşteri memnuniyetini hedef olarak belirleyen sektörüne değer katan bir markadır.

İç pazarda 300+ aktif iş ortağı ve yurtdışında 5 kıtada sayısı her gün artan 80+ ülkeye gerçekleştirdiği ihracatıyla Albatür, Türkiye ve dünyada mobilya aksesuarlarında hayata değer katan çözümler sunar.

Bu yolculukta bizimle beraber olan değerli iş ortaklarımıza, paydaşlarımıza, çalışanlarımıza, ürünlerimizi tercih eden müşterilerimize ve bizleri destekleyen herkese gönülden teşekkür ediyoruz.

About Us

In Turkey's leading Sliding System Company Albatür Industry Inc's journey was started in Bursa at 1976

Our Company, which serves different sectors with its own identity, since 2003 has determined its focus on sliding folding systems and sliding door systems.

With 45 years of production experience Albatür is manufacturing its products in Bursa's Nilüfer district 11.000 m² factory in modern facility and respected to nature.

All furniture fittings manufactured; R&D, design, mold, sheet metal forming, eccentric press, hydraulic press, plastic injection, cnc machining, electrostatic painting, wet painting, aluminum processing machines, assembly and robot automations has own in-house manufacture. Our production processes are under the control of our engineers who are experts in their fields.

Albatür, besides expanding living spaces with products it has developed, is a brand that sets the highest level of customer satisfaction as a target with innovative and technological solutions and adds value to its sector.

Albatür provides solutions adding the value to life in furniture accessories in Turkey and around the World; today with 300+ active business partners in the domestic market and exports to more than 80+ countries the number of which is increasing day by day in 5 continents.

We sincerely thank to our valuable business partners, stakeholders, employees, customers and who prefer our products, supports and who have been with us on this journey.

Çevre Politikamız

ENVIRONMENTAL POLICY



Albatur Endüstri A.Ş., yürüttüğü tüm faaliyetlerde çevrenin korunmasını, sürekli iyileştirmeyi, doğal kaynakların etkin kullanılmasını, yasalara tam uyum ve kirliliğin önlenmesini, faaliyetleri sırasında oluşan atıkların öncelikli olarak kaynağında azaltılmasını ve ayrıştırılmasını, geri dönüşüme kazandırılmasını, en uygun yöntemlerle bertaraf edilmesini çevre politikasının temeli kabul eder.

Bu politika çerçevesinde ;

- Faaliyetlerimizin çevresel boyutlarını belirlemeyi, etkilerinin türlerini ve zararlarını tespit ederek çevresel etkileri en aza indirmek için en iyi yöntem ve teknolojileri kullanmayı,
- Çalışanlarımızı, tedarikçilerimizi ve taşeronlarımızı çevrenin korunması konusunda bilinçlendirmek amacıyla eğitim faaliyetleri düzenlemeyi,
- Mümkün olduğu kadar yenilenebilir enerji kaynaklarını seçip, doğal kaynakları verimli kullanmayı,
- Çevresel kirliliği önlemek amacıyla, yasal, uluslararası mevzuatları takip etmeyi ve bunlara uyum sağlayarak çevre performansını sürekli iyileştirmeyi görev edinmiştir.

Gelecek nesillere yaşanılabilir bir dünya bırakmanın sorumluluk olduğu düşüncesiyle, Albatur olarak üretimde kullandığımız elektriği güneş enerjisinden elde ediyoruz.

Albatur Industry Inc. adopts the environmental policy in all activities it carries out, continuous improvement, effective use of natural resources, full compliance with the law and prevention of pollution, reduction and separation of the wastes generated during its operations at the source, recycling and recycling with the most appropriate methods.

Within of this policy;

- Using the best methods and technologies to minimize environmental impacts by identifying environmental aspects of our operations, identifying the types and harms of impacts,
- To organize training activities to raise awareness of our employees, suppliers and subcontractors on environmental protection,
- Selecting as much renewable energy resources as possible,
- In order to prevent environmental pollution, it has the duty to follow the legal, international regulations and to continuously improve the environmental performance by adapting to them.

We think it is a responsibility for leave a livable world for future generations so we are getting electricity from solar energy for our production.



Yetkinlikler

COMPETENCES

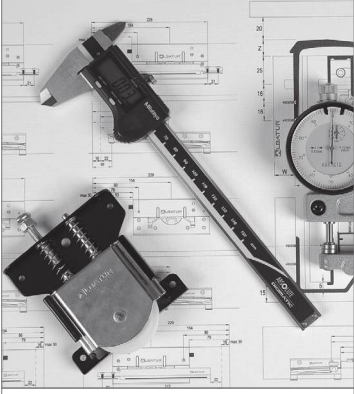

Kalite Kontrol
Quality Control



Ürün Montaj Videoları
Product Assembly Videos 3D



Ar-Ge Ürün Tasarım
R & D Product Design Process



Kalıp Tasarım ve İmalat
Mold Design Manufacturing



CNC Mekanik İşlem
CNC Machining Process



Sac Şekillendirme
Metal Sheet Forming



Robotik Otomasyon Üretim Hattı
Robotic Automation Production Line



Robotik Otomasyon Üretim Hattı
Robotic Automation Production Line



Plastik Enjeksiyon
Plastic Injection



Robotik Boya Tesisi
Robotics Paint Facility



Ürün Test Süreçleri
Products Test Process



Vibrasyon Hattı
Vibration Line



Alüminyum Profil İşleme
Aluminium Profile Processing



Geniş Ürün Stoklama
Wide Product Stocking



Montaj Prosesleri
Assembly Processes

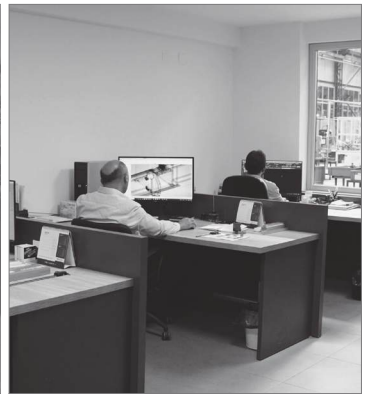

Mühendislik Süreçleri
Engineering Processes

Yetkinlikler

COMPETENCES

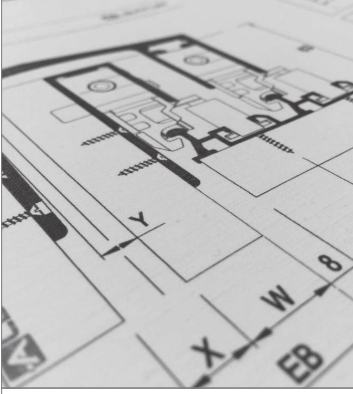

Teknik Dökümantasyon
Technical Documentation



Katalog
Catalog



Yeşil Enerji
We Care About Green Energy



Fuarlar
Exhibitions



Sertifikasyon
Certification

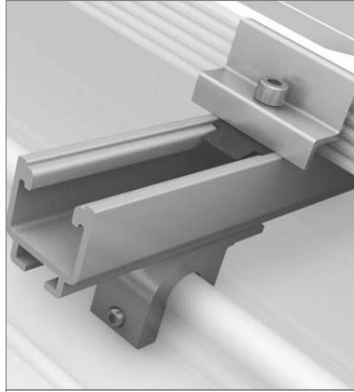

Özel Ürün Geliştirme
Special Product Development



Ürün Standları
Product Stands



Yurtiçi Satış Pazarlama
Domestic Sales Marketing



Satış Destek
Sales Support



İhracat
Export



ERP Süreç Takip Sistemi
ERP Process Control System



Ürün Tanıtım
Product Introduction



TSE Standartları
TSE Standards



Efectis Sertifika
Efectis Certificate



B2B Portal
B2B Portal

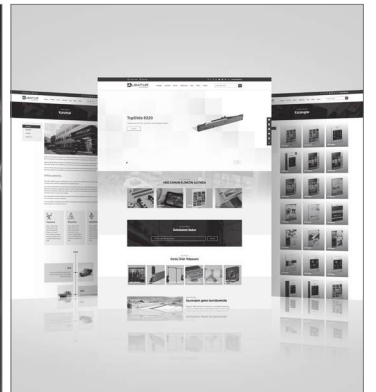

Dijital
Digital

Belgelerimiz ve Kalite Politikamız

CERTIFICATIONS AND QUALITY POLICY

KALİTE POLİTİKAMIZ

Firmamızın geleceğinin ve ekonomik gelişmesinin ana garantisi müşteri tatminidir. Bu aynı zamanda personel istihdamımızın da kilit faktörüdür. Müşteri tatminini garanti etmenin esas unsurları firmamızın ve tedarikçilerimizin kaliteli olmasıdır. Tüm çalışanlarımızın hareket tarzları ve profesyonellikleri ürünlerimizin kalitesini sağlamanın esasidir. Uzun süreli başarı ekonomik gelişme ve işin devamlılığı sadece başarılı müşteri ilişkileri ile sağlanır. Personel motivasyonu firma hedefidir. Bu firma içinde ve dışında kalite uğraşı verme anlamı taşır. Her çalışan kendi profesyonelliği ve davranışı ile ürün kalitesine katkıda bulunur.

QUALITY POLICY

The main guarantee of our company's future and economical developing is customer satisfaction. This is also a key factor in the employment of staff. The main instruments to guarantee customer satisfaction is our company and suppliers of high quality. Conduct and professionalism is the cornerstone of all of our employees to ensure quality of our products. Long-term success in economic development and business continuity is achieved by only a successful customer relationship. The staff motivation is goal of the company. This has the meaning-making within and outside the profession of quality in the company. Each employee contributes to their own professionalism and behavior and product quality.

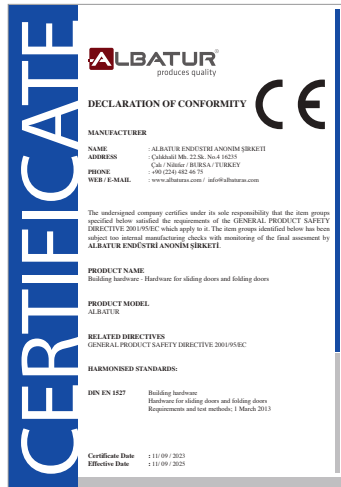

Belgelerimiz ve Kalite Politikamız

CERTIFICATIONS AND QUALITY POLICY

SÜREKLİ GELİŞİM

Yüksek seviyede müşteri tatminini, rekabet gücünü sağlamak ve proses kalitesini muhafaza etmek için uğraşmak bizce yeterli değildir. Hedefimiz kaliteyi devamlı geliştirmektir. En iyileri ile yarışarak en iyi olmak için çaba sarf ederiz. Biz diğer kişilerinde işlerinin önemli olduğu bilinci ile omuz omuza çalışırız.

Hepimiz kendi sahamızdaki uygulamalarda uzmanız. Ortak hedefleri başarmak için azami kişisel katılımları sağlama yolunda ekipler halinde çalışırız. Firmamızın başarısında katkıda buldukları için tedarikçilerimizi ortaklarımız olarak görürüz. Bağlantılı olarak firmamızı geliştirme ekibine aktif olarak katılmalarından emin olmak için en iyilerini seçeriz. Kalitemizi müşteri beklentilerine göre ölçeriz.

CONTINUOUS IMPROVEMENT

To ensure a high level of customer satisfaction and competitiveness is not enough to deal with in order to maintain the quality of the process. Our goal is to improve quality continuously. Strive to be the best in competing with the best. We work shoulder to shoulder with the understanding that other persons too have important jobs. We are all experts in their own department applications. In order to achieve common goals as a team work towards ensuring maximum personal participation.

We see our suppliers as partners for contributing to the success of our company. In connection with the development team in our company we choose the best ones to make sure that the active participation. Quality measure based on customer expectations.

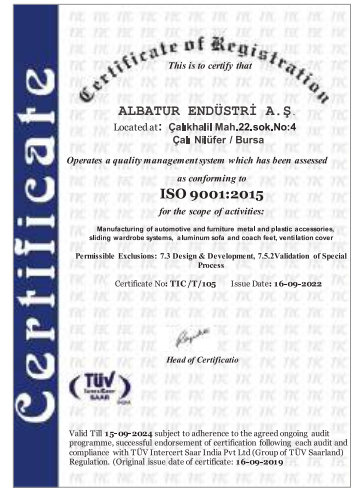
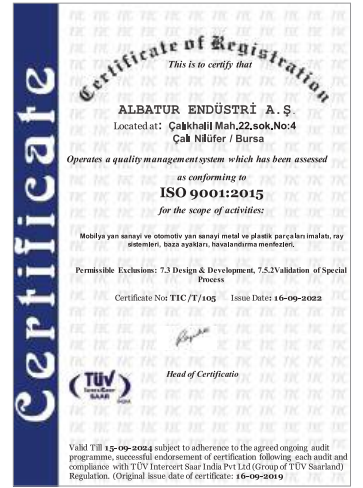

Kod Sistemi

CODE SYSTEM

Sipariş Kodu
Order Code

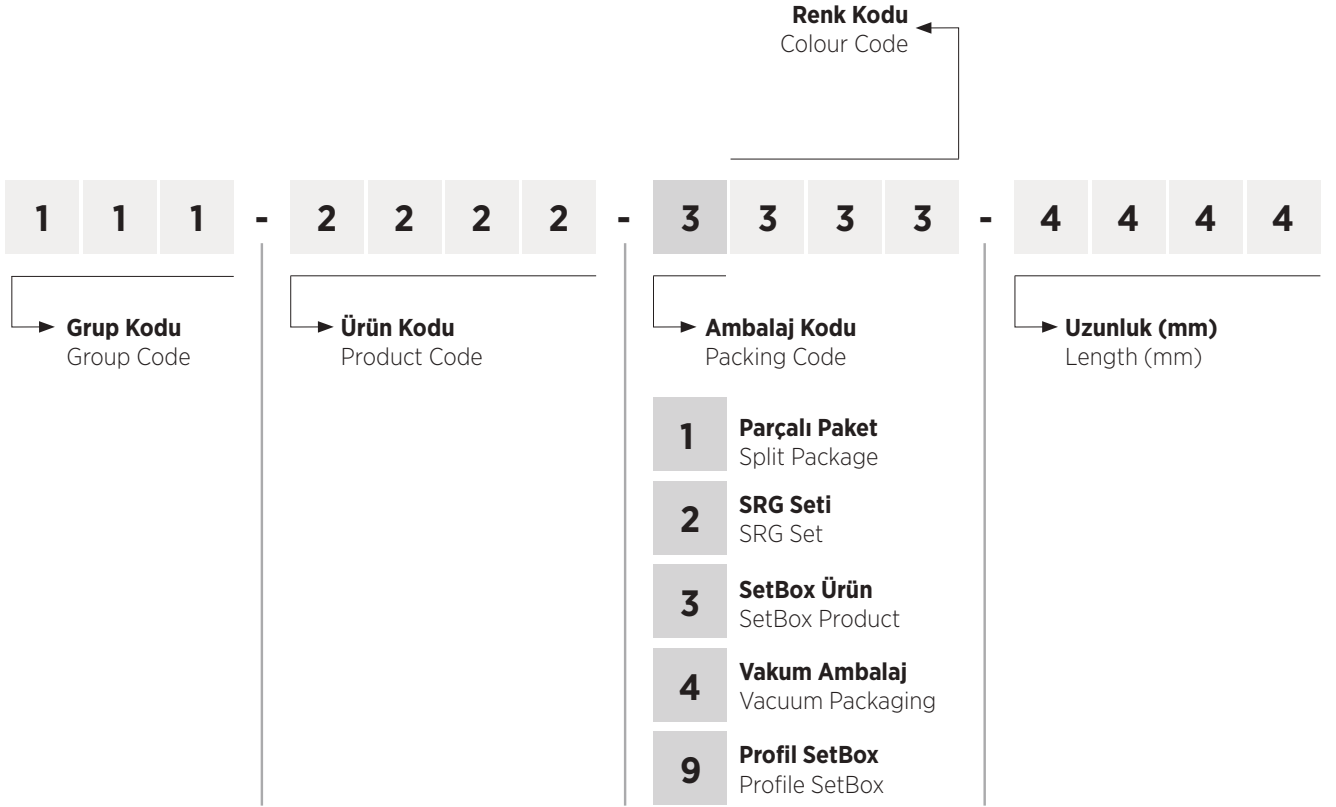

Sipariş Kodu
Order Code

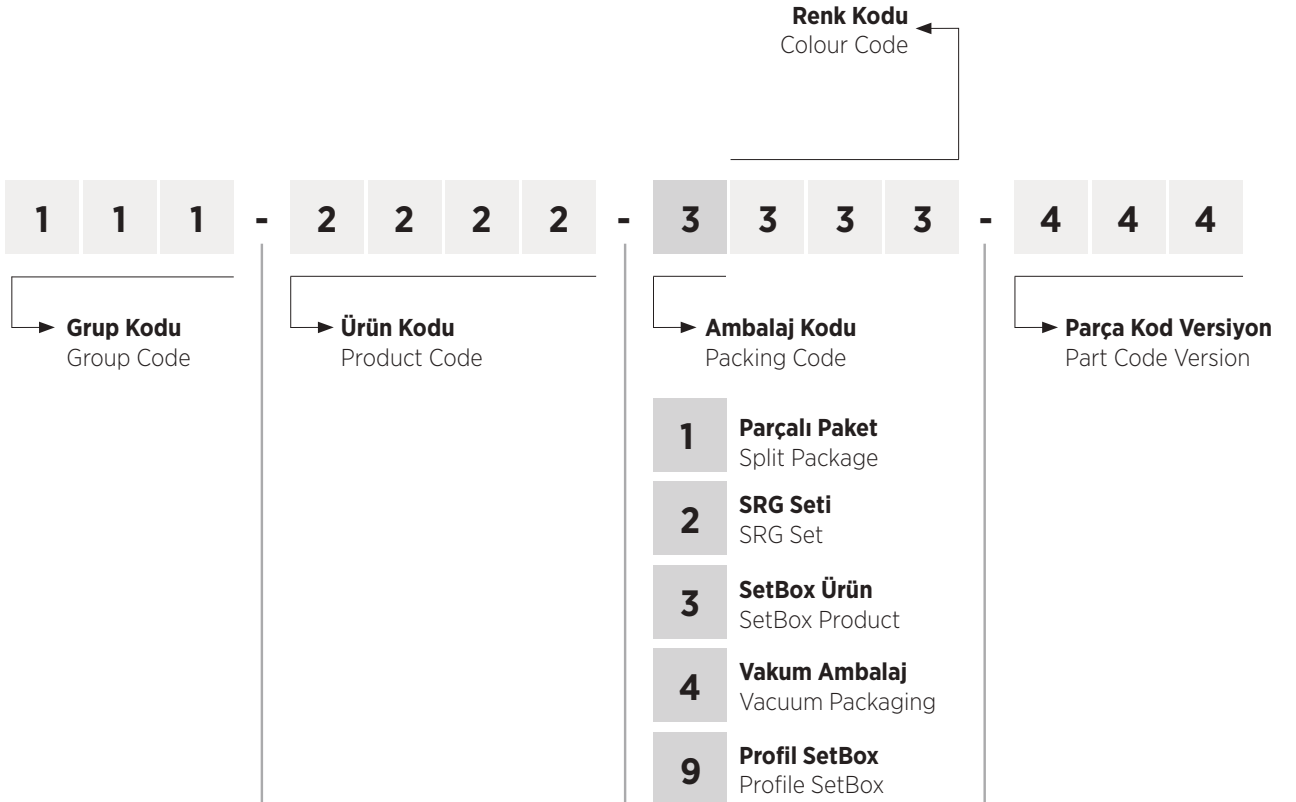

Semboller

SYMBOLS

| | | | | | | |
|--|--|--|---|--|---|---|
| 1  Dolap Sistemi Wardrobe System | 2  Kapı Sistemi Door System | 3  Teleskopik Kapı Sistemi Telescopic Door System | 4  Klasik Kapı Sistemi Classic Door System | 5  Çekmece Sistemi Drawer System | 6  İçten Sistem Internal System | 7  Dıştan Sistem External System |
| 8  Karma Alt Taşıyıcı Combined Bottom Carrier | 9  Karma Üst Taşıyıcı Combined Top Carrier | 10  Dıştan Tek Kanat External Single Door | 11  Üst Taşıyıcı Top Carrier | 12  L Kanat L Wing | 13  Katlanır Kapak Foldable Cabinet Door | 14  Sürme Kapı Sliding Door |
| 15  Sürme Kapı Sliding Door | 16  Senkronize Kapı Funicular Door | 17  Katlanır Kapı Foldable Door | 18  Katlanır Kapı Pivot Foldable Door Pivot | 19  Ahşap Wooden | 20  Cam Glass | 21  Ahşap - Cam Wooden - Glass |
| 22  Ahşap - Metal Wooden - Metal | 23  Stoper With Stopper | 24  Tek Yöne Yavaşlatıcı Uygulanabilir Apply to one Way Soft Closing | 25  Çift Yöne Yavaşlatıcı Uygulanabilir Apply to two Way Soft Closing | 26  Panel Kalınlık Panel Thickness | 27  Ağırık Weight | 28  Yükseklik Ayarlı Height Adjustable |
| 29  Yatay Ayarlı Horizontal Adjustable | 30  Dönüş Açısı Rotation Angel | 31  Rüzgar Yalıtım Wind Insulation | 32  Hava Geçer Air Pass Through | 33  Ses Yalıtımı Sound Proof | 34  Toz Yalıtımı Dust Insulation | 35  Işık Yalıtımı Özelliği Light Isolation Feature |
| 36  Yangın Dayanımlı Fire Resistance | 37  Duman Yalıtımı Smoke Proof | 38  Enerji Yalıtımı Özelliği Energy Isolation Feature | 39  Bozuk Yüzeylerde Uygulanabilir Can Be Applied to Faulty Surface | 40  Engelli Bireyler İçin Uygundur Suitable For Disabled People | 41  Haşereleri Engeller Pests Prevent | 42  Video Video |
| 43  Yağlı Piston Sistemi Oil Damper System | 44  Havalı Piston Sistemi Air Damper System | 45  Kutu İçİ Montaj Şeması Prospectus | 46  Elektrikli Electrical | 47  Set Ambalaj Set Packing | 48  Ürün Palet Miktarı Product Pallet Quantity | 49  Poşet Ambalaj Bag Packaging |
| 50  Kutu İçİ Miktar In-Box Quantity | 51  Koli İçİ Miktar In-Package Quantity | 52  Cam Delik Delme Glass Hole Drilling | 53  Alt Kılavuz Bottom Guide | 54  Cam Sıkıştırma Glass Compression | 55  90 Derece Katlanır Kapı 90 Degree Bi-Folding Door | 56  180 Derece Katlanır Kapı 180 Degree Bi-Folding Door |
| 57  Katlanır Kapı 2 Kanat Foldable Door 2 Door | 58  Katlanır Kapı 4 Kanat Foldable Door 4 Door | 59 | 60 | 61 | 62 | 63 |

Ürün Grupları

PRODUCT GROUPS

| | | | |
|---------------------------------------|---|---|--|
| Coplanar® |  | Hemyüz Sürme Gardırop Serisi Coplanar Sliding Wardrobe Series | Page 24 Group 101 |
| TopSlide® |  | Sürme Gardırop Serileri Sliding Wardrobe Series | Page 26 Group 102 |
| Multiline® |  | Sürme Kapak Serisi Sliding Door Series | Page 44 Group 103 |
| WingSlide® |  | Sürme Katlanır Kapak Serisi Sliding Foldable Door Series | Page 96 Group 105 |
| Glassline® |  | Sürme Cam Kapak Serisi Sliding Glass Door Series | Page 106 Group 108 |
| Rigel® |  | Sürme Ray Dolap Serisi Sliding Rail Wardrobe Series | Page 114 Group 109 |
| TvSlide® |  | Sürme Tv Ünite Serisi Sliding Tv Unit Series | Page 122 Group 110 |
| Softline® |  | Yavaşlatıcı Serisi Soft Closers Series | Page 124 Group 117 |
| Pulltens® |  | Çek-Ger Serisi Pull & Tension Series | Page 136 Group 118 |
| BarnDoor® |  | BarnDoor Sürme Kapı Serisi BarnDoor Sliding Door Series | Page 142 Group 119 |
| DoorSlide® |  | Ahşap Sürme Kapı Serisi Wooden Sliding Door Series | Page 150 Group 120 |
| DoorSync®Wood |  | Ahşap Senkronize Sürme Kapı Serisi Wooden Funicular Sliding Door Series | Page 174 Group 121 |
| MasterFold® MidFold® |  | Ahşap Katlanır Sürme Kapı Serisi Wooden Foldable Sliding Door Series | Page 184 122 |

Ürün Grupları

PRODUCT GROUPS

| | | | |
|--|---|--|--|
| GlassDoor® |  | Cam Sürme Kapı Serisi Glass Door Sliding Series | Page 200 Group 123 |
| DoorSync®Glass |  | Cam Senkronize Sürme Kapı Serisi Funicular Glass Door Series | Page 214 Group 124 |
| MultiDoor® |  | Teleskopik Ahşap Sürme Kapı Serisi Telescopic Wooden Sliding Door Series | Page 222 Group 127 |
| Underline® |  | Kapı Altı Giyotin Serisi Door Seal Series | Page 232 Group 130 |
| Door Hardware Kapı Donanımları |  | Kapı Donanımları Serisi Door Hardware Series | Page 240 Group 131 |
| MagicLift® |  | Gardırop Donanımları Serisi Wardrobe Equipments Series | Page 248 Group 135 |
| Ventil®Aluminium |  | Alüminyum Dekoratif Menfez Serisi Aluminium Air Ventilation Cover Series | Page 256 Group 140 |
| Ventil®Plastic |  | Plastik Dekoratif Menfez Serisi Plastic Air Ventilation Cover Series | Page 262 Group 141 |
| TurnTable® |  | Döner Tabla Mekanizma Serisi Swivel Plate - Turnable Table Series | Page 270 Group 142 |
| Master+ |  | Mobilya Aksesuar Serisi Furniture Accessories Series | Page 278 Group 143 |
| Feet |  | Koltuk ve Baza Ayakları Serisi Furniture Feet Series | Page 286 Group 144 |
| Aluminium |  | Alüminyum Profil Serisi Aluminium Profile Series | Page 292 Group 150 |
| 160-7000 Menteşe |  | Pivot Kapı Mekanizması Pivot Hinge Set | Page 294 Group 160 |

| | | |
|------------------|-------------------|---|
| 101 | Coplanar® | Hemyüz Sürme Gardırop Serisi • Coplanar Sliding Wardrobe Series |
| Coplanar 8888 | M01 8888 | Gardırop Hemyüz Sürme Kapak Sistemi • Coplanar Sliding Wardrobe System 18-40 mm25 |
| 102 | TopSlide® | Sürme Gardırop Serisi • Sliding Wardrobe Series |
| TopSlide 8220 | M02 8220 SFT | 100 Kg Çift Yöne Yavaşlatıcılı Sürme Gardırop Sistemi 16-20 mm28 100 Kg Sliding Wardrobe System With Two-Way Soft Closing |
| TopSlide 8232 | M02 8232 SFT | 100 Kg Çift Yöne Yavaşlatıcılı Sürme Gardırop Sistemi 18-30 mm29 100 Kg Sliding Wardrobe System With Two-Way Soft Closing |
| TopSlide 8235 | M02 8235 SFT | 100 Kg Çift Yöne Yavaşlatıcılı Sürme Gardırop Sistemi 18-35 mm30 100 Kg Sliding Wardrobe System With Two-Way Soft Closing |
| TopSlide 8240 | M02 8240 SFT | 100 Kg Çift Yöne Yavaşlatıcılı Sürme Gardırop Sistemi 18-40 mm31 100 Kg Sliding Wardrobe System With Two-Way Soft Closing |
| TopSlide 8250 | M02 8250 SFT | 100 Kg Çift Yöne Yavaşlatıcılı Sürme Gardırop Sistemi 18-50 mm32 100 Kg Sliding Wardrobe System With Two-Way Soft Closing |
| TopSlide 8223 | M02 8220 3K | 100 Kg Çift Yöne Yavaşlatıcılı 3 Kapaklı Sürme Gardırop Sistemi 16-20 mm33 100 Kg Sliding Wardrobe System 3 Door With Two-Way Soft Closing |
| TopSlide 8233 | M02 8232 3K | 100 Kg Çift Yöne Yavaşlatıcılı 3 Kapaklı Sürme Gardırop Sistemi 18-30 mm34 100 Kg Sliding Wardrobe System 3 Door With Two-Way Soft Closing |
| TopSlide 8320 | M02 8320 SFT | 100 Kg Çift Yöne Yavaşlatıcılı Sürme Gardırop Sistemi 16-18 mm35 100 Kg Sliding Wardrobe System With Two-Way Soft Closing |
| TopSlide 8080 | M02 8080 SFT | 100 Kg Çift Yöne Yavaşlatıcılı Sürme Gardırop Sistemi 18-28 mm36 100 Kg Sliding Wardrobe System With Two-Way Soft Closing |
| TopSlide 8040 | M02 8040 | 70 Kg Sürme Gardırop Sistemi 18 mm37 70 Kg Sliding Wardrobe System |
| TopSlide 8010 | M02 8010 | 60 Kg Sürme Gardırop Sistemi 18 mm38 60 Kg Sliding Wardrobe System |
| TopSlide 7320 | M02 7320 | 60 Kg Sürme Gardırop Sistemi 16-22 mm39 60 Kg Sliding Wardrobe System |
| TopSlide 8030 | M02 8030 | 60 Kg Sürme Gardırop Sistemi 16-25 mm40 60 Kg Sliding Wardrobe System |
| TopSlide 8400 | M02 8400 | 60 Kg Sürme Gardırop Sistemi 16-25 mm41 60 Kg Sliding Wardrobe System |
| TopSlide SRG 190 | M02 SRG 190 | 70 Kg Çift Yöne Yavaşlatıcılı Sürme Gardırop Sistemi 16-50 mm42 70 Kg Sliding Wardrobe System With Two-Way Soft Closing |
| TopSlide SRG 195 | M02 SRG 195 | 50 Kg Çift Yöne Yavaşlatıcılı Sürme Gardırop Sistemi 16-50 mm43 50 Kg Sliding Wardrobe System With Two-Way Soft Closing |
| 103 | Multiline® | Sürme Kapak Serisi • Sliding Door Series |
| Multiline 1 | | 50 Kg Çift Yöne Yavaş.Sürme Kapak Sistemi • Sliding Door System With Two-Way Soft Closing 16-22 mm47 |
| Multiline 2 | | 50 Kg Çift Yöne Yavaş.Sürme Kapak Sistemi • Sliding Door System With Two-Way Soft Closing 16-22 mm48 |
| Multiline 3 | | 40 Kg Sürme Kapak Sistemi • Sliding Door System • Sliding Door System 16-22 mm49 |
| Multiline 4 | | 50 Kg Çift Yöne Yavaş.Sürme Kapak Sistemi • Sliding Door System With Two-Way Soft Closing 16-30 mm50 |
| Multiline 5 | | 20 Kg Çift Yöne Yavaş.Sürme Kapak Sistemi • Sliding Door System With Two-Way Soft Closing 18-25 mm51 |
| Multiline 7 | | 50 Kg Çift Yöne Yavaş.Sürme Kapak Sistemi • Sliding Door System With Two-Way Soft Closing 18-30 mm52 |
| Multiline 8 | | 50 Kg Çift Yöne Yavaş.Sürme Kapak Sistemi • Sliding Door System With Two-Way Soft Closing 16-30 mm53 |
| Multiline 9 | | 45 Kg Çift Yöne Yavaş.Sürme Kapak Sistemi • Sliding Door System With Two-Way Soft Closing 18-30 mm54 |
| Multiline 10 | | 50 Kg Çift Yöne Yavaş.Sürme Kapak Sistemi • Sliding Door System With Two-Way Soft Closing 16-22 mm55 |
| Multiline 11 | | 50 Kg Çift Yöne Yavaş.Sürme Kapak Sistemi • Sliding Door System With Two-Way Soft Closing 16-22 mm56 |
| Multiline 12 | | 50 Kg Çift Yöne Yavaş.Sürme Kapak Sistemi • Sliding Door System With Two-Way Soft Closing 16-22 mm57 |

| | | |
|-------------------|--------------|--|
| Multiline 13 | | 50 Kg Çift Yöne Yavaş.Sürme Kapak Sistemi • Sliding Door System With Two-Way Soft Closing 16-22 mm58 |
| Multiline 14 | | 15 Kg Çift Yöne Yavaş.Sürme Kapak Sistemi • Sliding Door System With Two-Way Soft Closing 16-30 mm59 |
| Multiline 15 | | 50 Kg Çift Yöne Yavaş.Sürme Kapak Sistemi • Sliding Door System With Two-Way Soft Closing 18-22 mm60 |
| Multiline SRG 100 | M03 SRG 100 | 60 Kg Çift Yöne Yavaş.Sürme Kapak Sistemi • Sliding Door System With Two-Way Soft Closing 18-22 mm62 |
| Multiline SRG 300 | M03 SRG 300 | 70 Kg Çift Yöne Yavaş.Sürme Kapak Sistemi • Sliding Door System With Two-Way Soft Closing 18-22 mm63 |
| Multiline SRG 110 | M03 SRG 110 | 70 Kg Çift Yöne Yavaş.Sürme Kapak Sistemi • Sliding Door System With Two-Way Soft Closing 18-20 mm64 |
| Multiline SRG 115 | M03 SRG 115 | 70 Kg Çift Yöne Yavaş.Sürme Kapak Sistemi • Sliding Door System With Two-Way Soft Closing 18-20 mm65 |
| Multiline SRG 210 | M03 SRG 210 | 80 Kg Çift Yöne Yavaş.Sürme Kapak Sistemi • Sliding Door System With Two-Way Soft Closing 18-22 mm66 |
| Multiline SRG 120 | M03 SRG 120 | 80 Kg Çift Yöne Yavaş.Sürme Kapak Sistemi • Sliding Door System With Two-Way Soft Closing 18-22 mm68 |
| Multiline SRG 125 | M03 SRG 125 | 70 Kg Çift Yöne Yavaş.Sürme Kapak Sistemi • Sliding Door System With Two-Way Soft Closing 18-22 mm69 |
| Multiline SRG 130 | M03 SRG 130 | 60 Kg Çift Yöne Yavaş.Sürme Kapak Sistemi • Sliding Door System With Two-Way Soft Closing 18-22 mm70 |
| Multiline SRG 135 | M03 SRG 135 | 60 Kg Çift Yöne Yavaş.Sürme Kapak Sistemi • Sliding Door System With Two-Way Soft Closing 18-22 mm71 |
| Multiline SRG 140 | M03 SRG 140 | 60 Kg Çift Yöne Yavaş.Sürme Kapak Sistemi • Sliding Door System With Two-Way Soft Closing 18-22 mm72 |
| Multiline SRG 145 | M03 SRG 145 | 60 Kg Çift Yöne Yavaş.Sürme Kapak Sistemi • Sliding Door System With Two-Way Soft Closing 18-22 mm73 |
| Multiline 7036 | | 70 Kg Sürme Kapak Sistemi • Sliding Door System 18-20 mm74 |
| Multiline 7038 | | 70 Kg Sürme Kapak Sistemi • Sliding Door System 18-20 mm75 |
| Multiline 7030 | M03 7030 | 75 Kg Sürme Kapak Sistemi • Sliding Door System 18-22 mm76 |
| Multiline 7031 | M03 7030 E | 75 Kg Sürme Kapak Sistemi • Sliding Door System 18-30 mm77 |
| Multiline 7032 | M03 7030 SFT | 75 Kg Sürme Kapak Sistemi • Sliding Door System 18-22 mm78 |
| Multiline 7012 | M03 7010 SFT | 80 Kg Sürme Kapak Sistemi • Sliding Door System 18-22 mm79 |
| Multiline 7010 | M03 7010 | 80 Kg Sürme Kapak Sistemi • Sliding Door System 18-22 mm80 |
| Multiline 7011 | M03 7010 E | 70 Kg Sürme Kapak Sistemi • Sliding Door System 18-22 mm81 |
| Multiline 7020 | M03 7020 | 70 Kg Sürme Kapak Sistemi • Sliding Door System 18-22 mm82 |
| Multiline 7060 | M03 7060 | 60 Kg Sürme Kapak Sistemi • Sliding Door System 18-30 mm83 |
| Multiline 7055 | M03 7055 | 60 Kg Sürme Kapak Sistemi • Sliding Door System 18-30 mm84 |
| Multiline 6400 | M03 6400 | 45 Kg Sürme Kapak Sistemi • Sliding Door System 18-30 mm85 |
| Multiline 7040 | M03 7040 | 40 Kg Sürme Kapak Sistemi • Sliding Door System 18-30 mm86 |
| Multiline 7045 | M03 7045 | 45 Kg Sürme Kapak Sistemi • Sliding Door System 18-30 mm87 |
| Multiline 6500 | M03 6500 | 15 Kg Sürme Kapak Sistemi • Sliding Door System 18 mm88 |
| Multiline 6510 | M03 6510 | 15 Kg Sürme Kapak Sistemi • Sliding Door System 18 mm89 |
| Multiline 6000 | M03 6000 | 40 Kg Sürme Kapak Sistemi • Sliding Door System 18 mm90 |
| Multiline 0171 | M03 0171 | 30 Kg Sürme Kapak Sistemi • Sliding Door System 18 mm91 |
| Multiline 6600 | M03 6600 | 25 Kg Sürme Kapak Sistemi • Sliding Door System 18 mm92 |
| Multiline 6320 | M03 6320 | 19 Kg Sürme Kapak Sistemi • Sliding Door System 18 mm93 |
| Multiline 6100 | M03 6100 | 30 Kg Sürme Kapak Sistemi • Sliding Door System 18 mm94 |
| Multiline 7601 | M03 7600 PK | 15 Kg Sürme Kapak Sistemi • Sliding Door System 16-30 mm95 |

| | | |
|----------------|----------|---|
| WingSlide 7400 | M05 7400 | 25 Kg Katlanır Sürme Gardirop Sistemi • Sliding System For Folding Doors 18 mm98 |
| WingSlide 7405 | M05 7405 | 25 Kg Katlanır Sürme Gardirop Sistemi • Sliding System For Folding Doors 18 mm99 |
| WingSlide 7410 | M05 7410 | 15 Kg Katlanır Sürme Gardirop Sistemi • Sliding System For Folding Doors 18 mm100 |
| WingSlide 7420 | M05 7420 | 40 Kg Katlanır Sürme Gardirop Sistemi • Sliding System For Folding Doors 18 mm101 |
| WingSlide 7430 | M05 7430 | 40 Kg Katlanır Sürme Gardirop Sistemi • Sliding System For Folding Doors 18 mm102 |
| WingSlide 7440 | M05 7440 | 40 Kg Katlanır Sürme Gardirop Sistemi • Sliding System For Folding Doors 18 mm103 |
| WingSlide 7441 | | 40 Kg Katlanır Sürme Gardirop Sistemi • Sliding System For Folding Doors 18 mm104 |

| 108 | | Glassline® | Sürme Cam Kapak Serisi • Sliding Glass Door Series |
|----------------|---------------|--|--|
| Glassline 2 | | 20 Kg Sürme Yavaşlatıcı Cam Kapak Sistemi • Soft Closing Sliding Glass Door System | 4-5 mm 108 |
| Glassline 7500 | M08 7500 | 25 Kg Alüminyum Çerçeve Sürgü Sistemi • Sliding Aluminium Door System | 4-6 mm 110 |
| Glassline 7600 | M08 7600 | 15 Kg Sürme Cam Kapak Sistemi • Sliding Glass Door System | 4 mm 111 |
| Glassline 7700 | M08 7700 | 25 Kg Sürme Cam Kapak Sistemi • Sliding Glass Door System | 4-6 mm 112 |
| Glassline 7702 | M08 7700 Plus | 25 Kg Sürme Cam Kapak Sistemi • Sliding Glass Door System | 4-6 mm 113 |

| 109 | | Rigel® | Sürme Ray Dolap Serisi • Sliding Rail Wardrobe Series |
|------------|----------|--|---|
| Rigel 1 | | 50 Kg Çift Yöne Yavaşlatıcı Sürme Pano Sistemi | 4-8 mm 116 |
| | | 50 Kg Sliding Panel System With Two-Way Soft Closing | |
| Rigel 2 | | 50 Kg Çift Yöne Yavaşlatıcı Sürme Pano Sistemi | 4-8 mm 117 |
| | | 50 Kg Sliding Panel System With Two-Way Soft Closing | |
| Rigel 3 | | 50 Kg Çift Yöne Yavaşlatıcı Sürme Pano Sistemi | 4-8 mm 118 |
| | | 50 Kg Sliding Panel System With Two-Way Soft Closing | |
| Rigel 4 | | 50 Kg Sürme Pano Sistemi | 4-8 mm 119 |
| | | 50 Kg Sliding Panel System | |
| Rigel 1801 | M09 0180 | 60 Kg Sürme Pano Sistemi | 4-8 mm 121 |
| | | 60 Kg Sliding Panel System | |

| 110 | | TvSlide® | Sürme Tv Ünite Serisi • Sliding Tv Unit Series |
|--------------|--|--|--|
| TvSlide 5100 | | 45 Kg Tv Ünitesi Sürme Kapak Sistemi • Tv Unit Sliding Door System | 123 |

| 117 | | Softline® | Yavaşlatıcı Serisi • Soft Closers Series |
|---------------|----------|--|--|
| Softline 6710 | M17 6710 | 100 Kg Yavaşlatıcı Sistem • Soft Closer System | 127 |
| Softline 6711 | | 100 Kg Yavaşlatıcı Sistem • Soft Closer System | 127 |
| Softline 6666 | M17 6666 | 60 Kg Yavaşlatıcı Sistem • Soft Closer System | 128 |
| Softline 6740 | | 60 Kg Yavaşlatıcı Sistem • Soft Closer System | 128 |
| Softline 6940 | M17 6940 | 40 Kg Yavaşlatıcı Sistem • Soft Closer System | 129 |
| Softline 6950 | M17 6950 | 50 Kg Yavaşlatıcı Sistem • Soft Closer System | 129 |
| Softline 6970 | M17 6970 | 70 Kg Yavaşlatıcı Sistem • Soft Closer System | 130 |
| Softline 6800 | M17 6800 | 80 Kg Yavaşlatıcı Sistem • Soft Closer System | 130 |
| Softline 6810 | M17 6810 | 80 Kg Yavaşlatıcı Sistem • Soft Closer System | 131 |
| Softline 6942 | M17 6942 | 50 Kg Yavaşlatıcı Sistem • Soft Closer System | 131 |
| Softline 6901 | M17 6901 | 50 Kg Yavaşlatıcı Sistem • Soft Closer System | 132 |
| Softline 6820 | M17 6820 | 80 Kg Yavaşlatıcı Sistem • Soft Closer System | 132 |
| Softline 6990 | M17 6990 | 80 Kg Yavaşlatıcı Sistem • Soft Closer System | 133 |
| Softline 6700 | M17 6700 | 80 Kg Yavaşlatıcı Sistem • Soft Closer System | 133 |
| Softline 6922 | M17 6922 | 50 Kg Yavaşlatıcı Sistem • Soft Closer System | 134 |
| Softline 6921 | M17 6921 | 70 Kg Yavaşlatıcı Sistem • Soft Closer System | 134 |
| Softline 6959 | | 50 Kg Yavaşlatıcı Sistem • Soft Closer System | 135 |

| 118 | | Pulltens® | Çek-Ger Serisi • Pull-Tension Series |
|-------------|-----------|--|--------------------------------------|
| Pulltens 1 | M18 CG-01 | Metal Çek-Ger Donanımı • Pull Tension Metal | 138 |
| Pulltens 2 | M18 CG-02 | Metal Boy Çek-Ger • Pull Tension Metal | 138 |
| Pulltens 5 | M18 CG-05 | Plastik Başlıklı Çek-Ger • Pull Tension Plastic | 139 |
| Pulltens 6 | M18 CG-06 | Plastik Başlı Alüminyum Çek-Ger • Pull Tension Aluminium | 139 |
| Pulltens 7 | M18 CG-07 | Zamak Başlı Alüminyum Çek-Ger • Pull Tension Aluminium | 140 |
| Pulltens 9 | M18 CG-09 | Alüminyum Boy Çek-Ger • Pull Tension Aluminium | 140 |
| Pulltens 11 | M18 CG-11 | Zamak Başlı Gizli Çek-Ger Donanımı • Pull Tension Metal | 141 |
| Pulltens 12 | M18 CG-12 | Metal Çek-Ger Donanımı • Pull Tension Metal | 141 |

119 BarnDoor® Üstten Askı Ahşap Sürme Kapı Serisi • Top Hanger Wooden Sliding Door Series

| | | | | |
|---------------|--------------|---|----------|-----|
| BarnDoor 8800 | M20 8800 | 60 Kg Üstten Askı Ahşap Sürme Kapı Sistemi • Top Hanger Wooden Sliding Door System..... | 32-50 mm | 144 |
| BarnDoor 8820 | M20 8820 SFT | 80 Kg Çift Yöne Yavaşlatıcılı Üstten Askı Ahşap Sürme Kapı Sistemi | 32-50 mm | 145 |
| | | 80 Kg Top Hanger Wooden Sliding Door System - Two Way Soft Closing | | |
| BarnDoor 8900 | M23 8900 | 60 Kg Üstten Askı Ahşap Sürme Cam Kapı Sistemi • Top Hanger Glass Sliding Door System..... | 8-12 mm | 146 |
| BarnDoor 8920 | M23 8920 SFT | 80 Kg Çift Yöne Yavaşlatıcılı Üstten Askı Cam Sürme Kapı Sistemi | 8-12 mm | 147 |
| | | 80 Kg Top Hanger Glass Sliding Door System - Two Way Soft Closing | | |
| BarnDoor 8810 | | 60 Kg Üstten Askı Ahşap Sürme Kapı Sistemi • Top Hanger Wooden Sliding Door System..... | 32-50 mm | 148 |
| BarnDoor 8830 | | 80 Kg Çift Yöne Yavaş.Sürme Kapı Sistemi • Sliding Door System - Two Way Soft Closing | 32-50 mm | 149 |

120 DoorSlide® Ahşap Sürme Kapı Serisi • Wooden Sliding Door Series

| | | | | |
|----------------|--------------|---|----------|-----|
| DoorSlide 1000 | | 60 Kg Ayarlı Sürme Kapı Sistemi • Sliding Door System | 25-60 mm | 152 |
| DoorSlide 9010 | M20 9010 SFT | 60 Kg Ayarlı Çift Yöne Yavaş.Sürme Kapı Sistemi • Sliding Door System - Two Way Soft Closing | 25-60 mm | 154 |
| DoorSlide 9015 | M20 9015 SFT | 60 Kg Ayarlı Çift Yöne Yavaş.Sürme Kapı Sistemi • Sliding Door System - Two Way Soft Closing | 30-60 mm | 155 |
| DoorSlide 9012 | M20 9012 SFT | 60 Kg Ayarlı Çift Yöne Yavaş.Sürme Kapı Sistemi • Sliding Door System - Two Way Soft Closing | 25-60 mm | 156 |
| DoorSlide 9020 | M20 9020 SFT | 40 Kg Çift Yöne Yavaşlatıcılı Sürme Kapı Sistemi • Sliding Door System - Two Way Soft Closing..... | 25-60 mm | 157 |
| DoorSlide 9701 | M20 9700 SFT | 120 Kg Tek Yöne Yavaşlatıcılı Sürgü Kapı Sistemi • Sliding Door System - One Way Soft Closing..... | 20-60 mm | 158 |
| DoorSlide 9706 | M20 9705 SFT | 120 Kg Tek Yöne Yavaşlatıcılı Sürgü Kapı Sistemi • Sliding Door System - One Way Soft Closing..... | 30-60 mm | 159 |
| DoorSlide 9720 | M20 9720 SFT | 120 Kg Çift Yöne Yavaşlatıcılı Sürgü Kapı Sistemi • Sliding Door System - Two Way Soft Closing..... | 20-60 mm | 160 |
| DoorSlide 9725 | M20 9725 SFT | 120 Kg Çift Yöne Yavaşlatıcılı Sürgü Kapı Sistemi • Sliding Door System - Two Way Soft Closing..... | 30-60 mm | 161 |
| DoorSlide 7090 | M20 7090 | 80 Kg Sürgülü Kapı Sistemi • Sliding Door System | 18-50 mm | 162 |
| DoorSlide 7099 | M20 7099 | 80 Kg Sürgülü Kapı Sistemi Rulmanlı • Sliding Door System Has Ball Bearing | 18-50 mm | 163 |
| DoorSlide 7310 | M20 7310 | 51 Kg Sürgülü Kapı Sistemi • Sliding Door System | 18-50 mm | 164 |
| DoorSlide 7340 | M20 7340 | 60 Kg Sürgülü Kapı Sistemi • Sliding Door System | 18-50 mm | 165 |
| DoorSlide 7380 | M20 7380 | 80 Kg Sürgülü Kapı Sistemi Rulmanlı • Sliding Door System Has Ball Bearing | 18-50 mm | 166 |
| DoorSlide 9600 | M20 9600 | 160 Kg Sürgülü Kapı Sistemi • Sliding Door System | 18-50 mm | 167 |
| DoorSlide 9100 | M20 9100 | 250 Kg Sürgülü Kapı Sistemi • Sliding Door System | 40-50 mm | 168 |
| DoorSlide 9200 | M20 9200 | 250 Kg Sürgülü Kapı Sistemi • Sliding Door System | 40-50 mm | 169 |
| DoorSlide 9700 | M20 9700 | 120 Kg Sürgülü Kapı Sistemi • Sliding Door System | 20-60 mm | 170 |
| DoorSlide 9705 | M20 9705 | 120 Kg Sürgülü Kapı Sistemi • Sliding Door System | 30-60 mm | 171 |
| DoorSlide 7120 | M20 7120 | 120 Kg Sürgülü Kapı Sistemi • Sliding Door System | 25-50 mm | 172 |

121 DoorSync® Wood Ahşap Senkronize Sürme Kapı Serisi • Wooden Funicular Sliding Door Series

| | | | | |
|---------------|--------------|--|----------|-----|
| DoorSync 9800 | M21 9800 | 120 Kg Halatlı Sürgü Kapı Sistemi • Funicular Sliding Door System..... | 20-60 mm | 176 |
| DoorSync 9810 | M21 9810 | 80 Kg Halatlı Sürgü Kapı Sistemi • Funicular Sliding Door System | 20-50 mm | 177 |
| DoorSync 9801 | M21 9800 SFT | 120 Kg Yavaş.Halatlı Sürgü Kapı Sistemi • Funicular Sliding Door System - One Way Soft Closing | 20-60 mm | 178 |
| DoorSync 9820 | M21 9820 SFT | 120 Kg Çift Yöne Yavaşlatıcılı Halatlı Sürgü Kapı Sistemi • Funicular Sliding Door System | 20-60 mm | 179 |
| DoorSync 9830 | M21 9830 SFT | 60 Kg Yavaş.Halatlı Sürgü Kapı Sistemi • Funicular Sliding Door System Two Way Soft Closing | 25-60 mm | 180 |
| DoorSync 9840 | M21 9840 SFT | 40 Kg Çift Yöne Yavaşlatıcılı Halatlı Sürgü Kapı Sistemi • Funicular Sliding Door System | 25-60 mm | 181 |
| DoorSync 9850 | M21 9850 SFT | 60 Kg Çift Yöne Yavaşlatıcılı Halatlı Sürgü Kapı Sistemi • Funicular Sliding Door System | 25-60 mm | 182 |

122 MasterFold® - Midfold® Ahşap Katlanır Sürme Kapı Serisi • Wooden Foldable Sliding Door Series

| | | | | |
|----------------|----------|---|----------|-----|
| Domino 90 | | 45 Kg 90 Derece Açılır Katlanır Kapı Donanımı • 90 Degree Bi-Folding Door Hardware | 36-44 mm | 186 |
| Domino 180 | | 180 Kg 90 Derece Açılır Katlanır Kapı Donanımı • 90 Degree Bi-Folding Door Hardware | 36-44 mm | 187 |
| MasterFold 42 | | 40 Kg Katlanır Sürme Kapı Sistemi • Foldable Sliding Door Mechanism..... | 36-60 mm | 188 |
| MasterFold 44 | | 40 Kg Katlanır Sürme Kapı Sistemi • Foldable Sliding Door Mechanism..... | 36-60 mm | 189 |
| MasterFold 60 | | 60 Kg Katlanır Sürme Kapı Sistemi • Foldable Sliding Door Mechanism..... | 36-60 mm | 190 |
| MidFold 60 | | 60 Kg Katlanır Sürme Kapı Sistemi • Foldable Sliding Door Mechanism..... | 36-60 mm | 191 |
| MasterFold 160 | M22 9400 | 160 Kg Katlanır Sürme Kapı Sistemi • Foldable Sliding Door Mechanism..... | 40-50 mm | 192 |
| MidFold 160 | M22 9500 | 160 Kg Katlanır Sürme Kapı Sistemi • Foldable Sliding Door Mechanism..... | 40-50 mm | 193 |
| 122-1050-1800 | | Katlanır Kapı Kilit Mekanizması • Folding Door Lock Mechanism..... | | 194 |
| 122-1050-1820 | | Yer Soketi • Dust Proof Strike | | 195 |

| | | |
|----------------|--------------|---|
| GlassDoor 9906 | | 60 Kg Çift Yöne Yavaş. Sürme Cam Kapı Sistemi • Sliding Glass Door System - Two Way Soft Closing..8-12 mm202 |
| GlassDoor 9912 | | 120 Kg Çift Yöne Yavaş. Sürme Cam Kapı Sistemi • Sliding Glass Door System - Two Way Soft Closing....8-12 mm203 |
| GlassDoor 9910 | M23 9910 | 80 Kg Sürgü Cam Kapı Sistemi • Glass Door Sliding System8-12 mm204 |
| GlassDoor 9911 | | 80 Kg Sürgü Cam Kapı Sistemi • Glass Door Sliding System8-12 mm205 |
| GlassDoor 9900 | M23 9900 | 120 Kg Sürgü Cam Kapı Sistemi • Glass Door Sliding System8-12 mm206 |
| GlassDoor 9901 | | 120 Kg Sürgü Cam Kapı Sistemi • Glass Door Sliding System8-12 mm207 |
| GlassDoor 9030 | M23 9030 SFT | 60 Kg Çift Yöne Yavaşlatıcılı Sürme Cam Kapı Sistemi • Glass Door Sliding System8-12 mm208 |
| GlassDoor 9035 | M23 9035 SFT | 60 Kg Çift Yöne Yavaşlatıcılı Sürme Cam Kapı Sistemi • Glass Door Sliding System8-12 mm209 |
| GlassDoor 9902 | M23 9900 SFT | 120 Kg Ayarlı Tek Yöne Yavaşlatıcılı Sürgü Cam Kapı Sistemi • Glass Door Sliding System.....8-12 mm210 |
| GlassDoor 9903 | | 120 Kg Tek Yöne Yavaşlatıcılı Sürgü Cam Kapı Sistemi • Glass Door Sliding System8-12 mm211 |
| GlassDoor 9920 | M23 9920 SFT | 120 Kg Çift Yöne Yavaşlatıcılı Sürgü Cam Kapı Sistemi • Glass Door Sliding System8-12 mm212 |
| GlassDoor 9921 | | 120 Kg Çift Yöne Yavaşlatıcılı Sürgü Cam Kapı Sistemi • Glass Door Sliding System8-12 mm213 |

| | | |
|---------------|--------------|--|
| DoorSync 9935 | | 40 Kg Çift Yöne Yavaşlatıcılı Halatlı Sürme Cam Kapı Sistemi8-12 mm216 |
| DoorSync 9940 | M23 9940 | 40 Kg Funicular Sliding Glass Door System 80 Kg Halatlı Sürgü Cam Kapı Sistemi.....8-12 mm217 |
| DoorSync 9950 | M23 9950 | 80 Kg Funicular Sliding Glass Door System 120 Kg Halatlı Sürgü Cam Kapı Sistemi.....8-12 mm218 |
| DoorSync 9951 | M23 9950 SFT | 120 Kg Funicular Sliding Glass Door System 120 Kg Halatlı Tek Yöne Yavaşlatıcılı Sürgü Cam Kapı Sistemi.....8-12 mm219 |
| DoorSync 9960 | M23 9960 SFT | 120 Kg Funicular Glass Door Sliding System - One Way Soft Closing 120 Kg Çift Yöne Yavaşlatıcılı Halatlı Sürgü Cam Kapı Sistemi8-12 mm220 |
| | | 120 Kg Funicular Glass Door Sliding System - Two Way Soft Closing |

| | | |
|---------------|--|--|
| MultiDoor 100 | | 80 Kg Teleskopik Sürme Kapı Sistemi.....30-50 mm224 |
| MultiDoor 150 | | 80 Kg Teleskopik Sliding Door Systems 80 Kg Teleskopik Halatlı Sürme Kapı Sistemi30-50 mm225 |
| MultiDoor 200 | | 80 Kg Teleskopik Funicular Sliding Door Systems 80 Kg Tek Yöne Yavaşlatıcılı Teleskopik Sürme Kapı Sistemi.....30-50 mm226 |
| MultiDoor 250 | | 80 Kg Teleskopik Sliding Door Systems - One Way Soft Closing 80 Kg Tek Yöne Yavaşlatıcılı Halatlı Teleskopik Sürme Kapı Sistemi.....30-50 mm227 |
| MultiDoor 260 | | 80 Kg Teleskopik Funicular Sliding Door Systems - One Way Soft Closing 80 Kg Çift Yöne Yavaşlatıcılı Halatlı Teleskopik Sürme Kapı Sistemi30-50 mm228 |
| MultiDoor 400 | | 80 Kg Teleskopik Funicular Sliding Door Systems - Two Way Soft Closing 60 Kg Çift Yöne Yavaşlatıcılı Teleskopik Sürme Kapı Sistemi30-50 mm230 |
| MultiDoor 450 | | 60 Kg Teleskopik Sliding Door Systems - Two Way Soft Closing 60 Kg Çift Yöne Yavaşlatıcılı Halatlı Teleskopik Sürme Kapı Sistemi30-50 mm231 |
| | | 60 Kg Teleskopik Funicular Sliding Door Systems - Two Way Soft Closing |

| | | |
|---------------|----------|---|
| Underline 200 | M30 0200 | Kapı Altı Giyotini • Door Seal - Internal234 |
| Underline 210 | M30 0210 | Yangın Dayanımlı Kapı Altı Giyotini • Door Seal Fire Protection235 |
| Underline 220 | M30 0220 | Kapı Altı Giyotini-Dıştan • Door Seal -External.....236 |
| Underline 230 | M30 0230 | Yangına Dayanımlı Kapı Altı Giyotini - Dıştan • Door Seal Fire Protection-External237 |
| Underline 300 | | Kapı Altı Giyotini • Door Seal - Internal238 |

| | | | |
|----------------|--------------------------|---|-----|
| 131 | Door Hardware | Kapı Donanımları Serisi • Door Hardware Series | |
| 131-0100 | | Kilit Karşılığı Cebi • Lock Pocket | 242 |
| 131-0110 | | Kilit Karşılığı Cebi • Lock Pocket | 242 |
| 131-0120 | | Kilit Karşılığı Cebi • Lock Pocket | 243 |
| 131-0130 | | Kilit Karşılığı Cebi • Lock Pocket | 243 |
| 131-0200 | | Otomatik Kapı Sürgüsü (Yönsüz) • Automatic Door Bolt (Nondirective)..... | 244 |
| 131-0210 | | Yer Soketi • Dust Proof Strike | 245 |
| Menteşe | | Çelik Mentеше • Steel Hinge | 246 |
| Menteşe | | Çelik Mentеше • Steel Hinge | 246 |
| 135 | MagicLift® | Gardırop Donanımları Serisi • Wardrobe Equipments Series | |
| MagicLift 1100 | M35 1100 | 15 Kg Gardırop Asansörü • 15 Kg Lift For Wardrobe | 250 |
| MagicLift 1110 | M35 1110 | 10 Kg Gardırop Asansörü • 10 Kg Lift For Wardrobe | 251 |
| 135-1101 | | Gardırop Asansörü Montaj Aparatı • Lift For Wardrobe Mounting Apparatus | 252 |
| MagicLift 1200 | | 12 Kg Gardırop Asansörü • 12 Kg Lift For Wardrobe | 254 |
| 140 | Ventil® Aluminium | Alüminyum Dekoratif Menfez Serisi • Aluminium Air Ventilation Cover Series | |
| 140-0440 | M40 0440 | Alüminyum Bar Menfez • Aluminium Air Ventilation Cover | 258 |
| 140-0460 | M40 0460 | Alüminyum Bar Menfez • Aluminium Air Ventilation Cover | 258 |
| 140-0480 | M40 0480 | Alüminyum Bar Menfez • Aluminium Air Ventilation Cover | 258 |
| 140-0900 | M40 0900 | Alüminyum Koza Menfez • Aluminium Air Ventilation Cover | 260 |
| 140-0700 | M40 0700 | Alüminyum Koza Menfez • Aluminium Air Ventilation Cover | 260 |
| 140-0750 | M40 0750 | Alüminyum Koza Menfez • Aluminium Air Ventilation Cover | 260 |
| 140-0950 | M40 0950 | Alüminyum Kare Menfez • Aluminium Air Ventilation Cover..... | 261 |
| 140-0800 | M40 0800 | Alüminyum Kare Menfez • Aluminium Air Ventilation Cover..... | 261 |
| 140-0850 | M40 0850 | Alüminyum Kare Menfez • Aluminium Air Ventilation Cover..... | 261 |
| 141 | Ventil® Plastic | Plastik Dekoratif Menfez Serisi • Plastic Air Ventilation Cover Series | |
| 141-0680 | M41 0680 | Plastik Menfez • Plastic Air Ventilation Cover • 76 X 430 mm | 264 |
| 141-0650 | M41 0650 | Plastik Menfez • Plastic Air Ventilation Cover • 70 X 466 mm | 264 |
| 141-0630 | M41 0630 | Plastik Menfez • Plastic Air Ventilation Cover • 51 X 215 mm | 265 |
| 141-0640 | M41 0640 | Plastik Menfez • Plastic Air Ventilation Cover • 35 X 164 mm | 265 |
| 141-0670 | M41 0670 | Plastik Menfez • Plastic Air Ventilation Cover • 50 X 50 mm | 266 |
| 141-0600 | M41 0600 | Plastik Menfez • Plastic Air Ventilation Cover • 200 X 30 mm | 266 |
| 141-0620 | M41 0620 | Plastik Menfez • Plastic Air Ventilation Cover • Ø 34 mm..... | 267 |
| 141-0625 | M41 0625 | Plastik Menfez • Plastic Air Ventilation Cover • Ø 34 mm..... | 267 |
| 141-0660 | M41 0660 | Plastik Menfez • Plastic Air Ventilation Cover • Ø 44 mm..... | 268 |
| 141-0610 | M41 0610 | Plastik Menfez • Plastic Air Ventilation Cover • Ø 60 mm..... | 268 |
| 142 | TurnTable® | Döner Tabla Mekanizma Serisi • Swivel Plate - Turnable Table Series | |
| TurnTable 60 | M42 0060 | Döner Tabla Mekanizması / Swivel Plate - Turnable Table Mechanism..... | 272 |
| TurnTable 61 | M42 0061 | Döner Tabla Mekanizması / Swivel Plate - Turnable Table Mechanism..... | 273 |
| TurnTable 62 | M42 0062 | Döner Tabla Mekanizması / Swivel Plate - Turnable Table Mechanism..... | 273 |
| TurnTable 65 | M42 0065 | Döner Tabla Mekanizması / Swivel Plate - Turnable Table Mechanism..... | 274 |
| TurnTable 67 | M42 0067 | Döner Tabla Mekanizması / Swivel Plate - Turnable Table Mechanism..... | 274 |
| TurnTable 68 | M42 0068 | Döner Tabla Mekanizması / Swivel Plate - Turnable Table Mechanism..... | 275 |
| TurnTable 70 | M42 0070 | Konum Sabitleyici • Swivel Location Stabilizer | 275 |
| TurnTable 75 | M42 0075 | Döner Tabla Mekanizması / Swivel Plate - Turnable Table Mechanism..... | 276 |
| TurnTable 81 | M42 0081 | Konum Sabitleyici • Swivel Location Stabilizer | 276 |

| | | | |
|--------------|--|---|------------|
| 143 | Master+ | Mobilya Aksesuarları • Furniture Accessories | |
| 151-0001 | M51 0001 | Alt Pvc Profil • Bottom Pvc Profile..... | 280 |
| 151-0002 | M51 0002 | Üst Pvc Profil • Top Pvc Profile..... | 280 |
| 143-1328-001 | M43 1328 | Tezgah Önü Tapası • Banco Return To Plug..... | 280 |
| 143-1328-002 | M43 1328 | Tezgah Önü Tapası • Banco Return To Plug..... | 280 |
| 143-2413 | M43 2413 | Plastik Askı Boru Flanşı • Hanger Pipe Flange..... | 281 |
| 143-7056 | M43 7056 | 120 Kg Baza Taşıyıcı Teker • Bed Base Carrier Roller..... | 281 |
| 143-1000 | | Panel Bileşeni • Panel Component..... | 282 |
| 143-1010 | | Panel Bileşeni • Panel Component..... | 282 |
| 143-1020 | | Panel Bileşeni • Panel Component..... | 283 |
| 143-1030 | | Panel Bileşeni • Panel Component..... | 283 |
| 143-1040 | | Panel Bileşeni • Panel Component..... | 284 |
| 143-1050 | | Panel Bileşeni • Panel Component..... | 284 |
| 143-1060 | | Panel Bileşeni • Panel Component..... | 285 |
| 143-1070 | | Panel Bileşeni • Panel Component..... | 285 |
| 144 | Feet | Koltuk ve Baza Ayakları Serisi • Furniture Feet Series | |
| 144-0001 | M44 0001 | Alüminyum Teleskopik Stand • Aluminium Telescopic Stand..... | 288 |
| 144-0129 | M44 0129 | Ayarlı Baza Mekanizması • Adjustable Bed Base Mechanism..... | 289 |
| 144-0115 | M44 0115 | Alüminyum Sunta Destek Ayak • Aluminium Furniture Feet • W 25 X 25 mm..... | 289 |
| 144-0120 | M44 0120 | Alüminyum Baza Köşe Ayak • Aluminium Bed Base Corner Feet..... | 289 |
| 144-0121 | M44 0121 | Alüminyum Baza Orta Ayak • Aluminium Bed Base Central Feet..... | 289 |
| 144-0127 | M44 0127 | Alüminyum Baza Ayak • Aluminium Furniture (Bed Base) Feet Ø 30 mm..... | 290 |
| 144-0131 | M44 0131 | Alüminyum Baza Ayak • Aluminium Bed Base Feet • W 38 X 38 mm..... | 290 |
| 144-0123 | M44 0123 | Alüminyum Baza Ayak • Aluminium Bed Base Feet • W 25 X 25 mm..... | 290 |
| 144-0124 | M44 0124 | Alüminyum Orta Ayak • Aluminium Furniture Feet • W 25 X 25 mm..... | 290 |
| 144-0125 | M44 0125 | Alüminyum Ayarlı Baza Ayak • Adjustable Bed Base Feet Ø 30 mm..... | 291 |
| 144-0126 | M44 0126 | Alüminyum Ayarlı Baza Orta Ayak • Adjustable Bed Base Central Feet Ø 30 mm..... | 291 |
| 144-0132 | M44 0132 | Alüminyum Baza Ayak • Aluminium Bed Base Feet W 40 X 40 mm..... | 291 |
| 144-0147 | M44 0147 | Alüminyum Baza Ayak • Aluminium Bed Base Feet Ø 50 mm..... | 291 |
| 150 | Alüminyum Profiller • Aluminium Profiles | | |
| | Teknik Bilgi / Technical Data | Alüminyum Profiller • Aluminium Profiles..... | 293 |
| 160 | 160-7000 • Pivot Kapı Mekanizması / Pivot Hinge Set | | |
| | 160-7000 | 200 Kg Pivot Kapı Mekanizması • Pivot Hinge Set..... | 295 |
| | Setbox Paketleme • Packaging | | 296 |
| | Çalışma Koşulları • Working Conditions | | 298 |
| | EN 1527 Euronorm Ürün Kalite Kodları • Euronorm Quality Codes of Products | | 299 |
| | Ürün Teşhir Standları • Product Display Stands | | 300 |
| | Sosyal Medya • Social Medias | | 301 |
| | Önemli Notlar • Important Notes | | 302 |
| | Kapak Ağırlığı Hesaplama Tablosu • Door Weight Calculation Table | | 304 |
| | Notlar • Notes | | 305 |

Yenilikler

INNOVATIONS



TopSlide **8400** Page 41

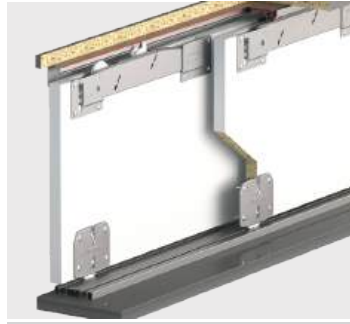

Multiline **1** Page 47

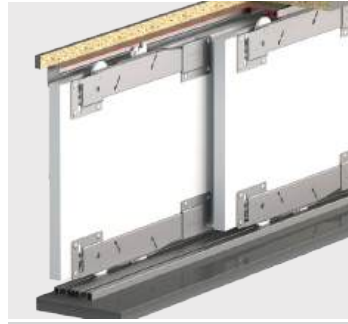

Multiline **2** Page 48



Multiline **3** Page 49



Multiline **4** Page 50



Multiline **5** Page 51



Multiline **7** Page 52



Multiline **8** Page 53



Multiline **9** Page 54



Multiline **10** Page 55

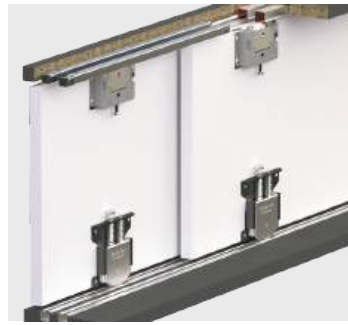

Multiline **11** Page 56



Multiline **12** Page 57



Multiline **13** Page 58



Multiline **14** Page 59

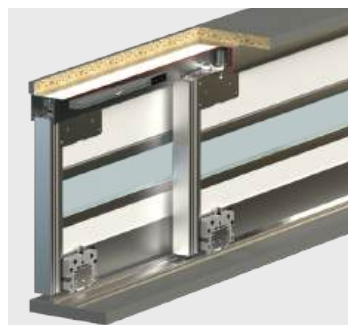

Multiline **15** Page 60

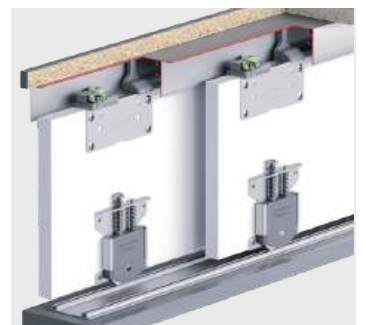

Multiline **SRG 115** Page 65



WingSlide **7441** Page 104

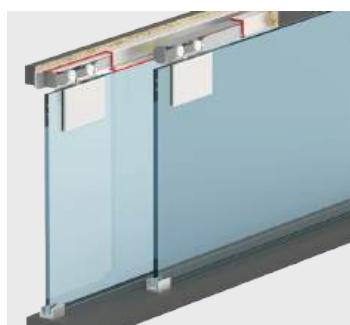

Glassline **2** Page 108

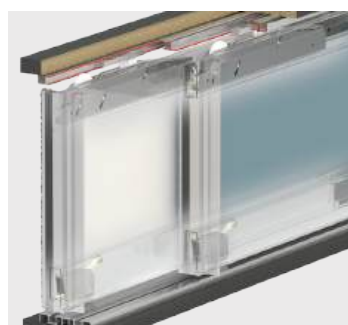

Rigel **1** Page 116

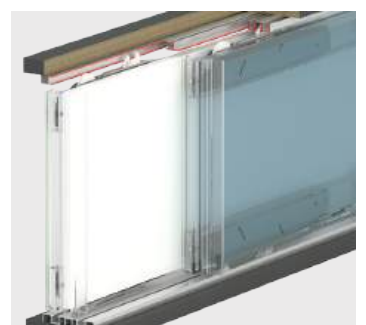

Rigel **2** Page 117

Yenilikler

INNOVATIONS

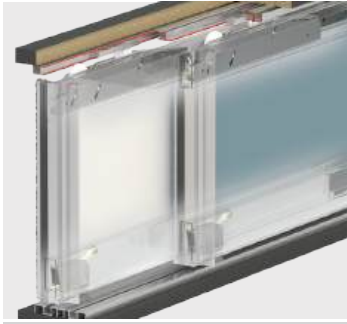

Rigel 3

Page 118

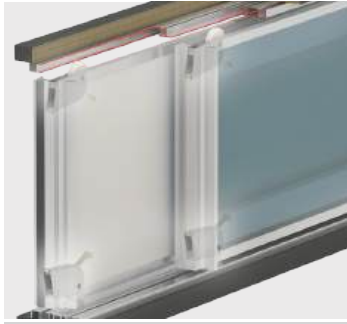

Rigel 4

Page 119



Softline **6711**

Page 127



Softline **6740**

Page 128



Softline **6959**

Page 135



119-8810

Page 148



119-8830

Page 149

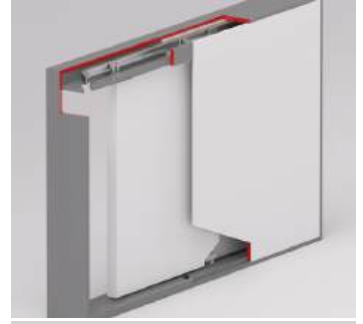

120-1000

Page 152



MasterFold **42**

Page 188



MasterFold **44**

Page 189



MasterFold **60**

Page 190



MidFold **60**

Page 191



122-1050

Page 194



122-1052

Page 195



Domino 90

Page 186

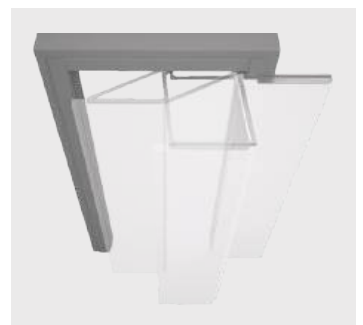

Domino 180

Page 187



123-9906

Page 202



GlassDoor **9912**

Page 203



MultiDoor **100**

Page 224



MultiDoor **150**

Page 225

Yenilikler

INNOVATIONS



MultiDoor **200** Page 226



MultiDoor **250** Page 227



127-0262 Page 228



MultiDoor **400** Page 230



MultiDoor **450** Page 231

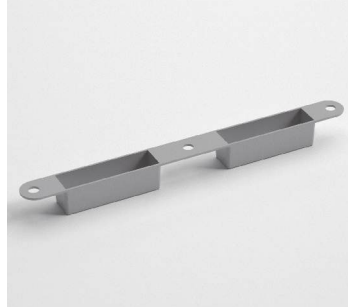

131-0120 Page 243



131-0130 Page 243



131-0200 Page 244



131-0210 Page 245



135-1200-3610 Page 254



135-1200-3620 Page 254



143-1000 Page 282



143-1010 Page 282



143-1020 Page 283



143-1030 Page 283



143-1040 Page 284



143-1050 Page 284



143-1060 Page 285



143-1070 Page 285



160-7000 Page 295

Group 101

Coplanar®

Hemyüz Sürme Gardırop Serisi

Coplanar Sliding Wardrobe Series



Bu serideki tüm ürünleri incelemek için QR kodu okutabilirsiniz.

You can search the QR code to see all the products in these series.

Coplanar 8888

GARDİROP HEMİYÜZ SÜRME KAPAK SİSTEMİ • COPLANAR SLIDING WARDROBE SYSTEM



Bilgi / Information

- Kapak yüksekliği 220 cm önerilir.
- Maksimum 40 kg / 1 kapak.
- Tek kanat uygulamalar için lütfen müşteri temsilciniz ile görüşünüz.

- Max. height of 220 cm is suitable for wardrobes.
- Maximum 40 kg / 1 door.
- For one wing applications please contact.

Yavaşlatıcı Alternatifi / Soft Closer Alternative

- Sistem üzerinde kapanış yönünde yavaşlatıcı mevcuttur.
- Sisteme haricen yavaşlatıcı uygulanamamaktadır.
- Soft closer is available in the direction of closing on the system.
- Soft closer can not be applied to the system.



101-8888 1 Set İçeriği / 1 Set Includes



Kulp Profilleri / Handle Profiles

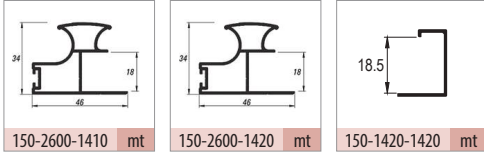

Opsiyonel Aksesuar / Optional Accessories

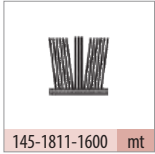

145-1811-1600 mt

Teknik Detay / Technical Detail

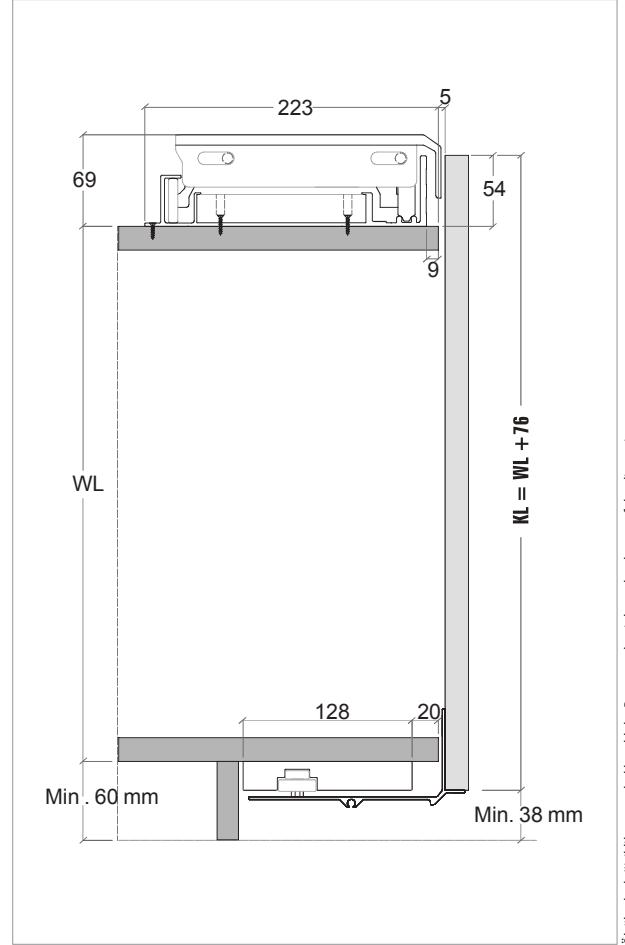

Ölçülerde değişiklik yapma hakkı saklıdır. Reserves the right to the change of the dimensions.

| Kod / Code No | Açıklama / Description | Renk / Colour | Birim / Unit | | | Profil mt. / Profiles mt. | Bağ / Bnd. |
|--------------------|---|------------------------|-----------------|-----|-------|---------------------------|------------|
| 101-8888-3410-1600 | Sürme Gardırop Sistemi / Coplanar Sliding Wardrobe System / 1600 mm | Gri / Grey | 2 Kapak / 1 Set | 1 | 12 | - - - | - |
| 101-8888-3410-1800 | Sürme Gardırop Sistemi / Coplanar Sliding Wardrobe System / 1800 mm | Gri / Grey | 2 Kapak / 1 Set | 1 | 12 | - - - | - |
| 101-8888-3410-2000 | Sürme Gardırop Sistemi / Coplanar Sliding Wardrobe System / 2000 mm | Gri / Grey | 2 Kapak / 1 Set | 1 | 12 | - - - | - |
| 101-8888-3410-2200 | Sürme Gardırop Sistemi / Coplanar Sliding Wardrobe System / 2200 mm | Gri / Grey | 2 Kapak / 1 Set | 1 | 12 | - - - | - |
| 101-8888-3410-2400 | Sürme Gardırop Sistemi / Coplanar Sliding Wardrobe System / 2400 mm | Gri / Grey | 2 Kapak / 1 Set | 1 | 12 | - - - | - |
| 145-1811-1600 | Kıl Fital / Ec-Wf Hair Wick | Gri / Grey | mt. | 300 | 7.200 | - - 3,0 | - |
| 150-2600-1410 | Alüminyum Kulp Profili / Aluminium Handle Profile | Eloksal / Mat Anodized | mt. | - | - | - - 3,0 | 6 ad/pcs |
| 150-2600-1420 | Alüminyum Kulp Profili / Aluminium Handle Profile | Parlak / Bright | mt. | - | - | - - 3,0 | 6 ad/pcs |
| 150-1420-1420 | Alüminyum Kapama Profili / Aluminium Closure Profile | Parlak / Bright | mt. | - | - | - - 3,0 | 10 ad/pcs |

Group 102

TopSlide®

Sürme Gardırop Serisi

Sliding Wardrobe Series



Bu serideki tüm ürünleri incelemek için QR kodu okutabilirsiniz.

You can search the QR code to see all the products in these series.



TopSlide **8220**



TopSlide **8232**



TopSlide **8235**



TopSlide **8240**



TopSlide **8250**



TopSlide **8223**



TopSlide **8233**



TopSlide **8320**



TopSlide **8080**

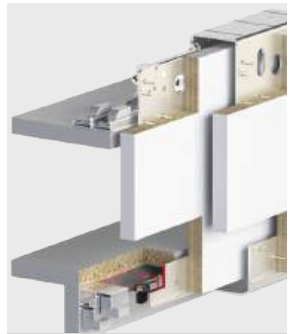

TopSlide **8040**



TopSlide **8010**



TopSlide **7320**



TopSlide **8030**



TopSlide **8400**

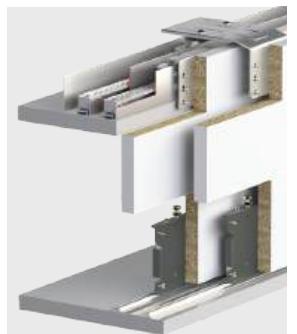

TopSlide **SRG 190**

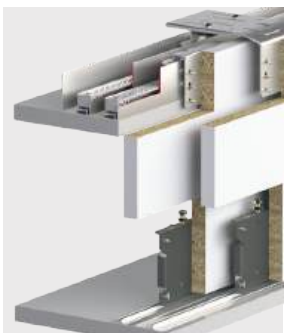

TopSlide **SRG 195**

TopSlide 8220

100 KG SÜRME GARDIROP SİSTEMİ • SLIDING WARDROBE SYSTEM



Bilgi / Information

- 1 Kutu İçeriği : 1 iç kapak + 1 dış kapak + 4 ad üst yavaşlatıcı + 4 ad alt yavaşlatıcı
- In 1 box : 1 internal door + 1 external door + 4 pcs Top soft closers + 4 pcs bottom soft closers



102-8220 1 Set İçeriği / 1 Set Includes



102-8203 Opsiyonel 3. İç Kapak / Optional 3. Internal Door



Ray Profilleri / Rail Profiles

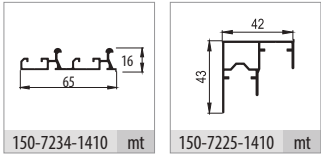

Kulp Profilleri / Handle Profiles

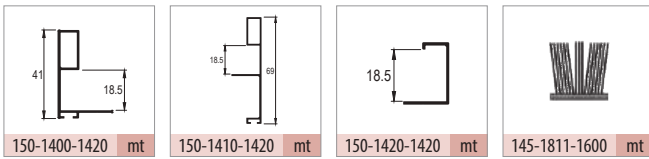

Teknik Detay / Technical Detail

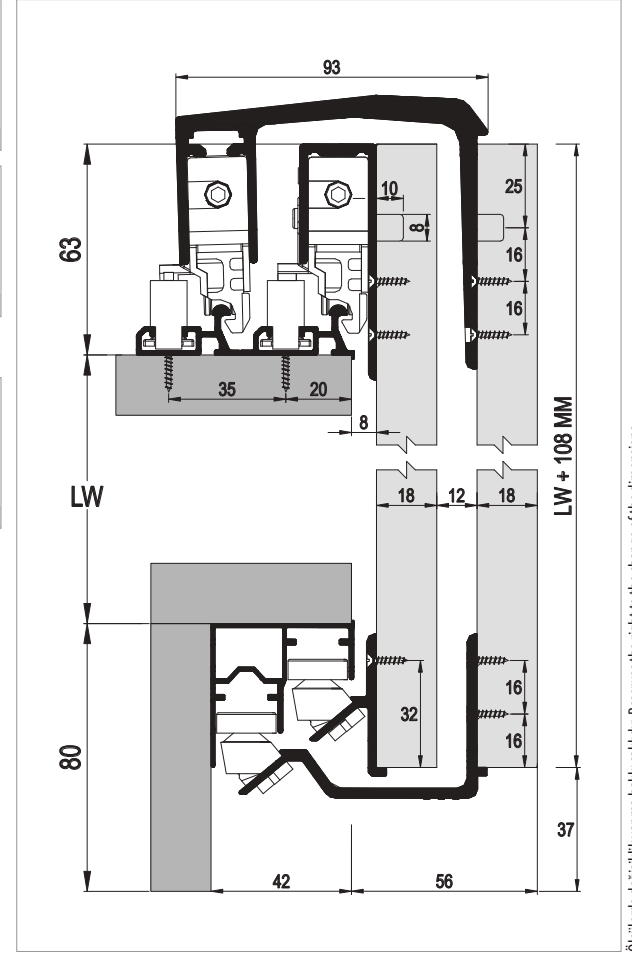

Ölçülerde değişiklik yapma hakkı saklıdır. Reserves the right to the change of the dimensions.

| Kod / Code No | Açıklama / Description | Renk / Colour | Birim / Unit | | | Profil mt. / Profiles mt. | Bağ / Bnd. |
|---------------|---|------------------------|-----------------|-----|-------|---------------------------|------------|
| 102-8220-1200 | Sürme Gardirop Sistemi / Sliding Wardrobe System | Silver | 2 Kapak / 1 Set | 6 | 144 | - | - |
| 102-8203-1200 | Sürme Gardirop Sistemi 3. Kapak / Sliding Wardrobe System 3. Door | Silver | 1 Kapak / 1 Kit | 8 | 400 | - | - |
| 145-1811-1600 | Kıl Fital / Ec-Wf Hair Wick | Gri / Grey | mt. | 300 | 7.200 | - | - |
| 150-7234-1410 | Alüminyum Üst Ray Profili / Aluminium Top Rail Profile | Eloksal / Mat Anodized | mt. | - | - | 2,0 | 2,5 |
| 150-7225-1410 | Alüminyum Alt Ray Profili / Aluminium Bottom Rail Profile | Eloksal / Mat Anodized | mt. | - | - | 2,0 | 2,5 |
| 150-1400-1420 | Alüminyum Kulp Profili / Aluminium Handle Profile | Parlak / Bright | mt. | - | - | - | 2,7 |
| 150-1410-1420 | Alüminyum Kulp Profili / Aluminium Handle Profile | Parlak / Bright | mt. | - | - | - | 2,7 |
| 150-1420-1420 | Alüminyum Kapama Profili / Aluminium Closure Profile | Parlak / Bright | mt. | - | - | - | 3,0 |

TopSlide 8232

100 KG SÜRME GARDIROP SİSTEMİ • SLIDING WARDROBE SYSTEM



Bilgi / Information

- 1 Kutu İçeriği : 1 iç kapak + 1 dış kapak + 4 ad üst yavaşlatıcı + 4 ad alt yavaşlatıcı
- In 1 box : 1 internal door + 1 external door + 4 pcs Top soft closers + 4 pcs bottom soft closers



102-8232 1 Set İçeriği / 1 Set Includes



102-8203 Opsiyonel 3. İç Kapak / Optional 3. Internal Door



Ray Profilleri / Rail Profiles

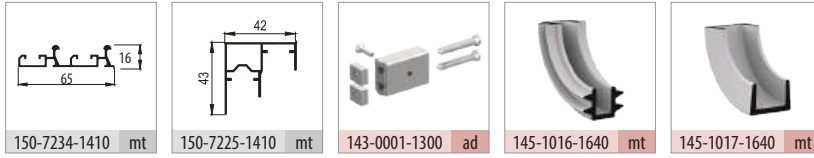

Aksesuar / Accessory

Kulp Profilleri / Handle Profiles

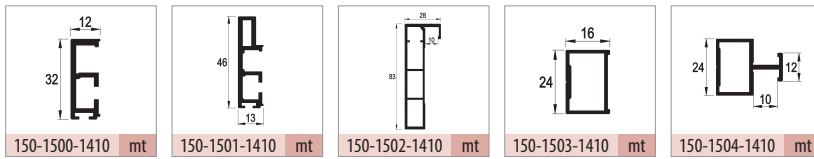

Teknik Detay / Technical Detail

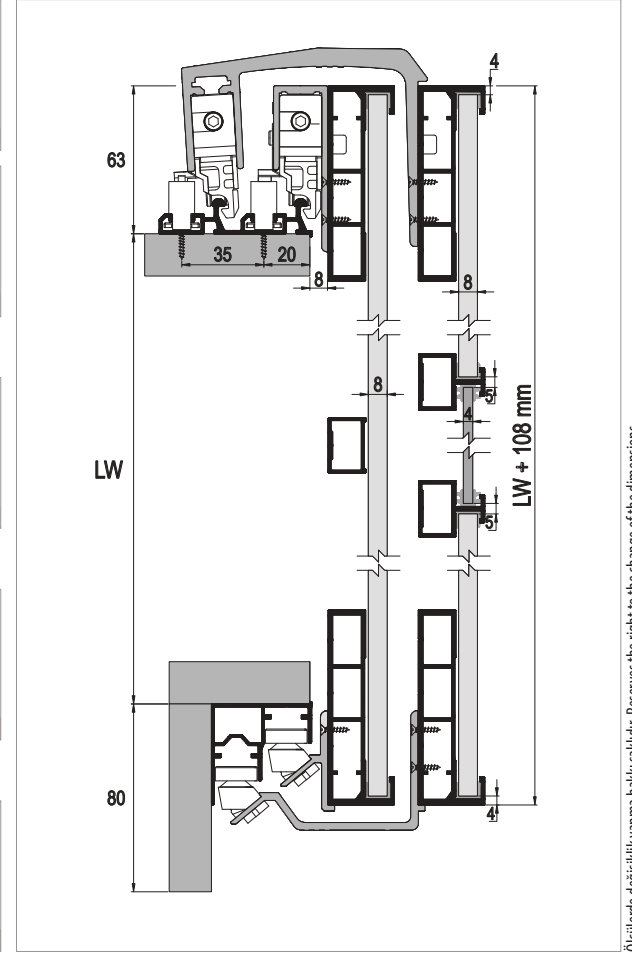

Ölçülerde değişiklik yapma hakkı saklıdır. Reserves the right to the change of the dimensions.

| Kod / Code No | Açıklama / Description | Renk / Colour | Birim / Unit | | | Profil mt. / Profiles mt. | Bağ / Bnd. |
|---------------|---|------------------------|-----------------|-----|-------|---------------------------|------------|
| 102-8232-1200 | Sürme Gardirop Sistemi / Sliding Wardrobe System | Silver | 2 Kapak / 1 Set | 6 | 144 | - - - | - |
| 102-8203-1200 | Sürme Gardirop Sistemi 3. Kapak / Sliding Wardrobe System 3. Door | Silver | 1 Kapak / 1 Kit | 8 | 400 | - - - | - |
| 143-0001-1300 | Bağlantı Kiti / Connection Kit | Silver | 1 Adet / 1 Pcs | | | - - - | - |
| 145-1016-1640 | 4 mm Cam Fiteli / 4 mm Glass Wick | Şeffaf / Transparan | mt. | 100 | 3.600 | - - - | - |
| 145-1017-1640 | 8 mm Sunta Fiteli / 8 mm Panel Wick | Şeffaf / Transparan | mt. | 100 | 3.600 | - - - | - |
| 150-7234-1410 | Alüminyum Üst Ray Profili / Aluminium Top Rail Profile | Eloksal / Mat Anodized | mt. | - | - | 2,0 2,5 3,0 | 6 ad/pcs |
| 150-7225-1410 | Alüminyum Alt Ray Profili / Aluminium Bottom Rail Profile | Eloksal / Mat Anodized | mt. | - | - | 2,0 2,5 3,0 | 6 ad/pcs |
| 150-1500-1410 | Alüminyum Çerçeve Profili / Aluminium Frame Profile | Eloksal / Mat Anodized | mt. | - | - | - - 3,0 | 6 ad/pcs |
| 150-1501-1410 | Alüminyum Çerçeve Profili / Aluminium Frame Profile | Eloksal / Mat Anodized | mt. | - | - | - - 3,0 | 6 ad/pcs |
| 150-1502-1410 | Alüminyum Çerçeve Profili / Aluminium Frame Profile | Eloksal / Mat Anodized | mt. | - | - | - - 3,0 | 4 ad/pcs |
| 150-1503-1410 | Alüminyum Çerçeve Profili / Aluminium Frame Profile | Eloksal / Mat Anodized | mt. | - | - | - - 3,0 | 12 ad/pcs |
| 150-1504-1410 | Alüminyum Çerçeve Profili / Aluminium Frame Profile | Eloksal / Mat Anodized | mt. | - | - | - - 3,0 | 6 ad/pcs |

TopSlide 8235

100 KG SÜRME GARDIROP SİSTEMİ • SLIDING WARDROBE SYSTEM



Bilgi / Information

- 1 Kutu İçeriği : 1 iç kapak + 1 dış kapak + 4 ad üst yavaşlatıcı + 4 ad alt yavaşlatıcı
- In 1 box : 1 internal door + 1 external door + 4 pcs Top soft closers
+ 4 pcs bottom soft closers



102-8235 1 Set İçeriği / 1 Set Includes



102-8203 Opsiyonel 3. İç Kapak / Optional 3. Internal Door



Ray Profilleri / Rail Profiles

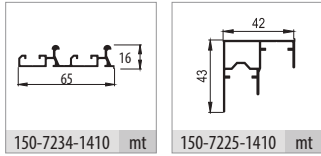

Uygulama / Application



Teknik Detay / Technical Detail

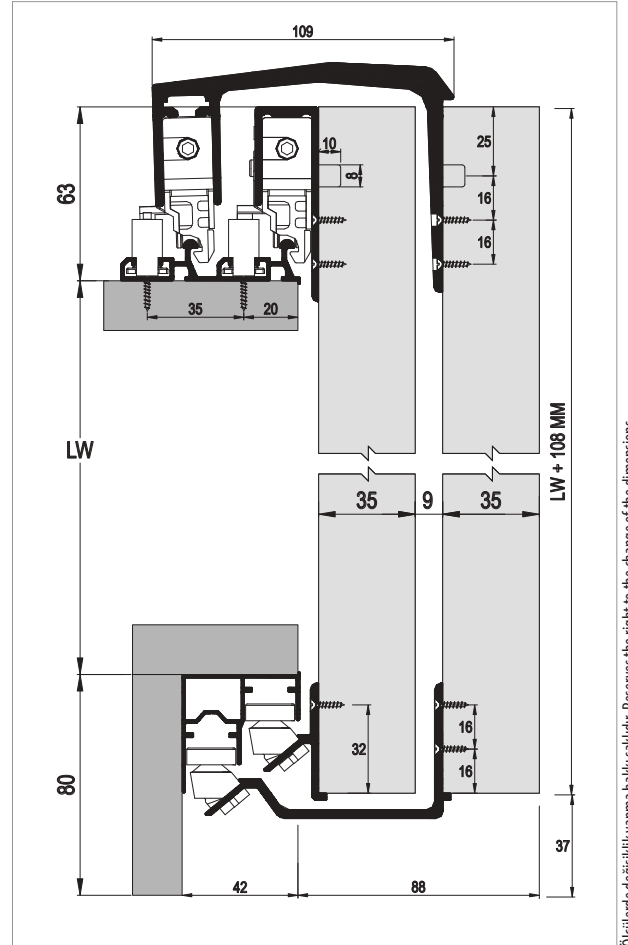

Ölçülerde değişiklik yapma hakkı saklıdır. Reserves the right to the change of the dimensions.

| Kod / Code No | Açıklama / Description | Renk / Colour | Birim / Unit | | | Profil mt. / Profiles mt. | Bağ / Bnd. |
|---------------|--|------------------------|-----------------|---|-----|---------------------------|------------|
| 102-8235-1200 | Sürme Gardrop Sistemi / Sliding Wardrobe System | Silver | 2 Kapak / 1 Set | 6 | 144 | - - - | - |
| 102-8203-1200 | Sürme Gardrop Sistemi 3. Kapak / Sliding Wardrobe System 3. Door | Silver | 1 Kapak / 1 Kit | 8 | 400 | - - - | - |
| 150-7234-1410 | Alüminyum Üst Ray Profili / Aluminium Top Rail Profile | Eloksal / Mat Anodized | mt. | - | - | 2,0 2,5 3,0 | 6 ad/pcs |
| 150-7225-1410 | Alüminyum Alt Ray Profili / Aluminium Bottom Rail Profile | Eloksal / Mat Anodized | mt. | - | - | 2,0 2,5 3,0 | 6 ad/pcs |

TopSlide 8240

100 KG SÜRME GARDIROP SİSTEMİ • SLIDING WARDROBE SYSTEM



Bilgi / Information

- 1 Kutu İçeriği : 1 iç kapak + 1 dış kapak + 4 ad üst yavaşlatıcı + 4 ad alt yavaşlatıcı
- In 1 box : 1 internal door + 1 external door + 4 pcs Top soft closers + 4 pcs bottom soft closers



102-8240 1 Set İçeriği / 1 Set Includes



102-8203 Opsiyonel 3. İç Kapak / Optional 3. Internal Door



Ray Profilleri / Rail Profiles

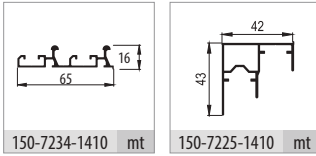

Uygulama / Application



Teknik Detay / Technical Detail

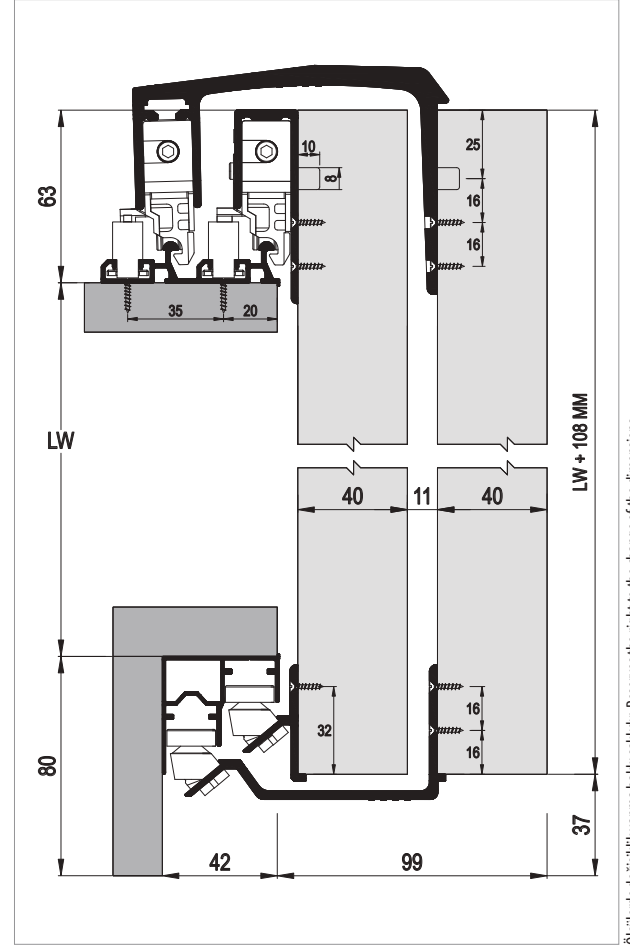

Ölçülerde değişiklik yapıma hakkı saklıdır. Reserves the right to the change of the dimensions.

| Kod / Code No | Açıklama / Description | Renk / Colour | Birim / Unit | | | Profil mt. / Profiles mt. | Bağ / Bnd. |
|---------------|--|------------------------|-----------------|---|-----|---------------------------|------------|
| 102-8240-1200 | Sürme Gardrop Sistemi / Sliding Wardrobe System | Silver | 2 Kapak / 1 Set | 6 | 144 | - - - | - |
| 102-8203-1200 | Sürme Gardrop Sistemi 3. Kapak / Sliding Wardrobe System 3. Door | Silver | 1 Kapak / 1 Kit | 8 | 400 | - - - | - |
| 150-7234-1410 | Alüminyum Üst Ray Profili / Aluminium Top Rail Profile | Eloksal / Mat Anodized | mt. | - | - | 2,0 2,5 3,0 | 6 ad/pcs |
| 150-7225-1410 | Alüminyum Alt Ray Profili / Aluminium Bottom Rail Profile | Eloksal / Mat Anodized | mt. | - | - | 2,0 2,5 3,0 | 6 ad/pcs |

TopSlide 8250

100 KG SÜRME GARDIROP SİSTEMİ • SLIDING WARDROBE SYSTEM



Bilgi / Information

- 1 Kutu İçeriği : 1 iç kapak + 1 dış kapak + 4 ad üst yavaşlatıcı + 4 ad alt yavaşlatıcı
- In 1 box : 1 internal door + 1 external door + 4 pcs Top soft closers + 4 pcs bottom soft closers



102-8250 1 Set İçeriği / 1 Set Includes



102-8203 Opsiyonel 3. İç Kapak / Optional 3. Internal Door



Ray Profilleri / Rail Profiles

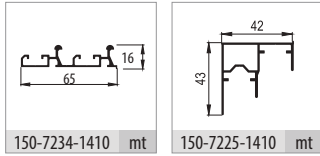

Uygulama / Application



Teknik Detay / Technical Detail

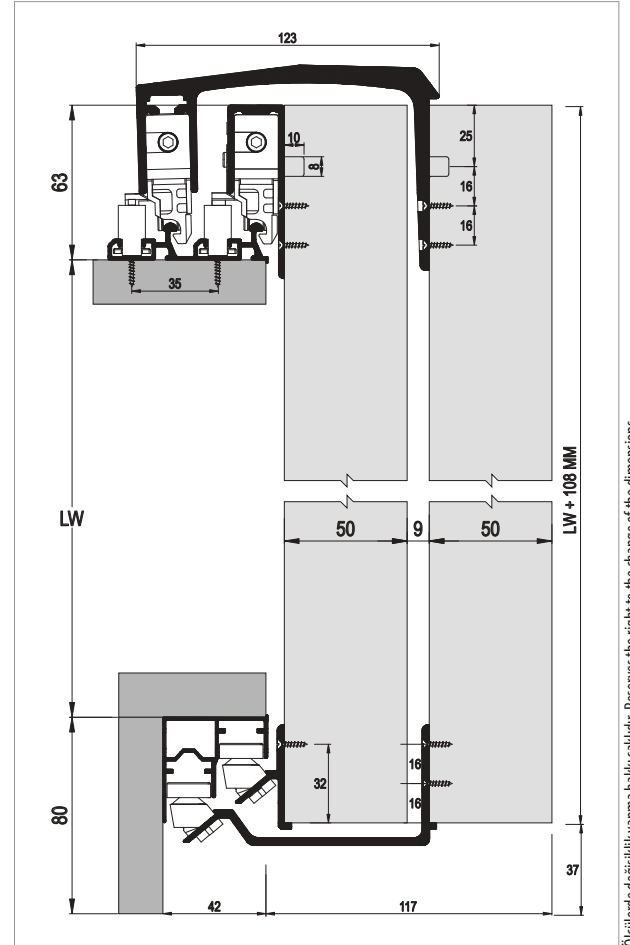

Ölçülerde değişiklik yapma hakkı saklıdır. Reserves the right to the change of the dimensions.

| Kod / Code No | Açıklama / Description | Renk / Colour | Birim / Unit | | | Profil mt. / Profiles mt. | Bağ / Bnd. |
|---------------|---|------------------------|-----------------|---|-----|---------------------------|------------|
| 102-8250-1200 | Sürme Gardrop Sistemi / Sliding Wardrobe System | Silver | 2 Kapak / 1 Set | 6 | 144 | - | - |
| 102-8203-1200 | Sürme Gardrop Sistemi 3. Kapak / Sliding Wardrobe System 3. Doo | Silver | 1 Kapak / 1 Kit | 8 | 400 | - | - |
| 150-7234-1410 | Alüminyum Üst Ray Profili / Aluminium Top Rail Profile | Eloksal / Mat Anodized | mt. | - | - | 2,0 2,5 3,0 | 6 ad/pcs |
| 150-7225-1410 | Alüminyum Alt Ray Profili / Aluminium Bottom Rail Profile | Eloksal / Mat Anodized | mt. | - | - | 2,0 2,5 3,0 | 6 ad/pcs |



Bilgi / Information

- 1 Kutu İçeriği : 2 iç kapak + 1 dış kapak + 7 ad üst yavaşlatıcı + 4 ad alt yavaşlatıcı
- 8223 Sürgü sisteminde dış kapak çift yöne çalışmakta ve yavaşlatıcı özelliği bulunmaktadır.
- In 1 box : 2 internal door + 1 external door + 7 pcs Top soft closers + 4 pcs bottom soft closers.
- 8223 In this sliding system external door running two way and the system has soft closing function.



102-8223 1 Set İçeriği / 1 Set Includes



Ray Profilleri / Rail Profiles

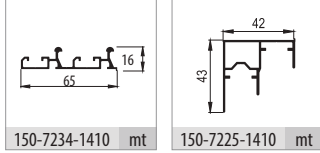

Kulp Profilleri / Handle Profiles

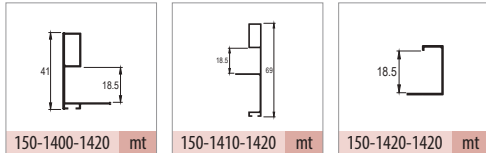

Opsiyonel Aksesuar / Optional Accessories

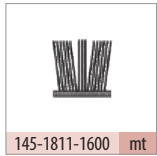

Teknik Detay / Technical Detail

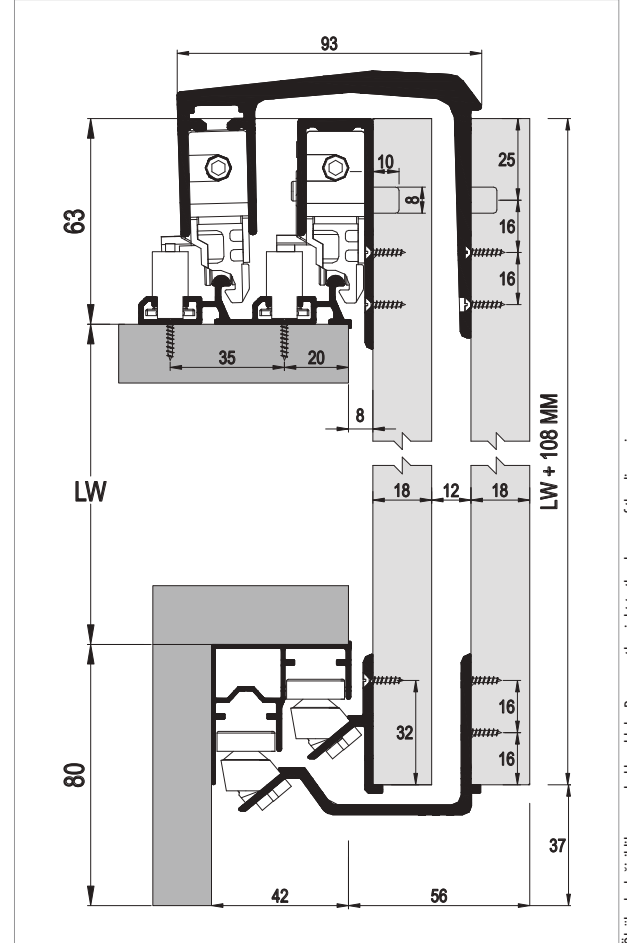

Ölçülerde değişiklik yapma hakkı saklıdır. Reserves the right to the change of the dimensions.

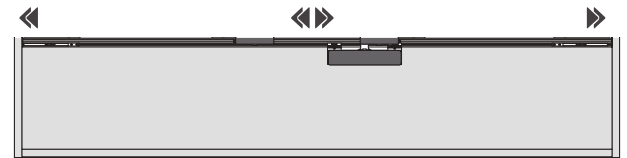

| Kod / Code No | Açıklama / Description | Renk / Colour | Birim / Unit | | | Profil mt. / Profiles mt. | Bağ / Bnd. |
|---------------|---|------------------------|-----------------|-----|-------|---------------------------|------------|
| 102-8223-1200 | Sürme Gardrop Sistemi / Sliding Wardrobe System | Silver | 3 Kapak / 1 Set | 5 | 90 | - - - | - |
| 145-1811-1600 | Kıl Fital / Ec-Wf Hair Wick | Gri / Grey | mt. | 300 | 7.200 | - - - | - |
| 150-7234-1410 | Alüminyum Üst Ray Profili / Aluminium Top Rail Profile | Eloksal / Mat Anodized | mt. | - | - | 2,0 2,5 3,0 | 6 ad/pcs |
| 150-7225-1410 | Alüminyum Alt Ray Profili / Aluminium Bottom Rail Profile | Eloksal / Mat Anodized | mt. | - | - | 2,0 2,5 3,0 | 6 ad/pcs |
| 150-1400-1420 | Alüminyum Kulp Profili / Aluminium Handle Profile | Parlak / Bright | mt. | - | - | - 2,70 - | 10 ad/pcs |
| 150-1410-1420 | Alüminyum Kulp Profili / Aluminium Handle Profile | Parlak / Bright | mt. | - | - | - 2,70 - | 10 ad/pcs |
| 150-1420-1420 | Alüminyum Kapama Profili / Aluminium Closure Profile | Parlak / Bright | mt. | - | - | - - 3,0 | 10 ad/pcs |



Bilgi / Information

- 1 Kutu İçeriği : 2 iç kapak + 1 dış kapak + 7 ad üst yavaşlatıcı + 4 ad alt yavaşlatıcı
- 8233 Sürgü sisteminde dış kapak çift yöne çalışmakta ve yavaşlatıcı özelliği bulunmaktadır.
- In 1 box : 2 internal door + 1 external door + 7 pcs Top soft closers + 4 pcs bottom soft closers.
- 8233 In this sliding system external door running two way and the system has soft closing function.



102-8233 1 Set İçeriği / 1 Set Includes



Ray Profilleri / Rail Profiles

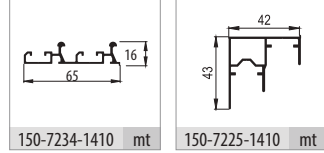

Uygulama / Application



Teknik Detay / Technical Detail

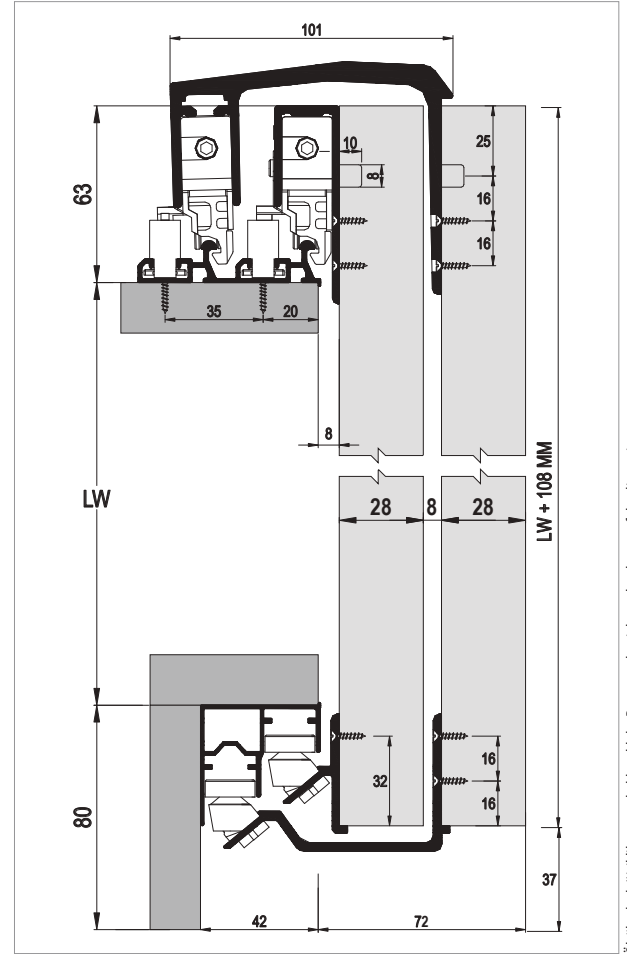

Ölçülerde değişiklik yapma hakkı saklıdır. Reserves the right to the change of the dimensions.

| Kod / Code No | Açıklama / Description | Renk / Colour | Birim / Unit | | | Profil mt. / Profiles mt. | Bağ / Bnd. |
|---------------|---|------------------------|-----------------|---|----|---------------------------|------------|
| 102-8233-1200 | Sürme Gardirop Sistemi / Sliding Wardrobe System | Silver | 3 Kapak / 1 Set | 5 | 90 | - | - |
| 150-7234-1410 | Alüminyum Üst Ray Profili / Aluminium Top Rail Profile | Eloksal / Mat Anodized | mt. | - | - | 2,0 2,5 3,0 | 6 ad/pcs |
| 150-7225-1410 | Alüminyum Alt Ray Profili / Aluminium Bottom Rail Profile | Eloksal / Mat Anodized | mt. | - | - | 2,0 2,5 3,0 | 6 ad/pcs |

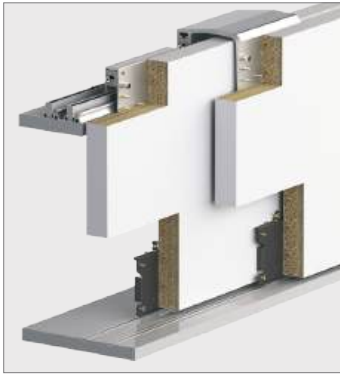

Bilgi / Information

- 1 Kutu İçeriği : 1 iç kapak + 1 dış kapak
- In 1 box : 1 internal door + 1 external door



102-8320 1 Set İçeriği / 1 Set Includes



102-8323 Opsiyonel 3. İç Kapak / Optional 3. Internal Door

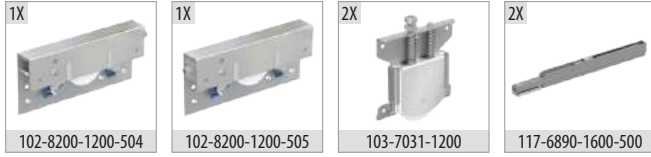

Ray Profilleri / Rail Profiles

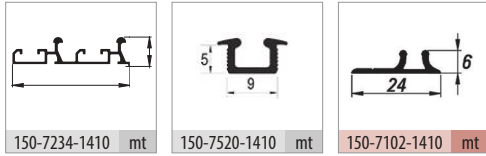

Kulp Profilleri / Handle Profiles

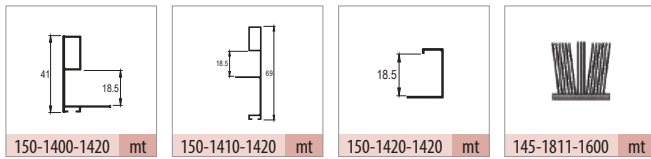

Teknik Detay / Technical Detail

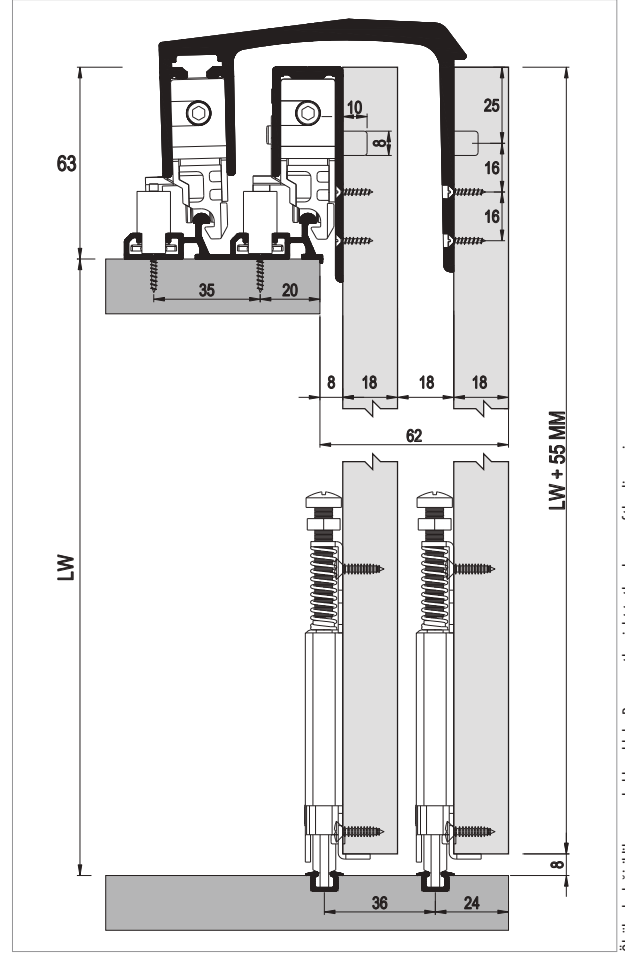

Ölçülerde değişiklik yapma hakkı saklıdır. Reserves the right to the change of the dimensions.

| Kod / Code No | Açıklama / Description | Renk / Colour | Birim / Unit | | | Profil mt. / Profiles mt. | Bağ / Bnd. |
|---------------|---|------------------------|-----------------|---|-----|---------------------------|------------|
| 102-8320-1200 | Sürme Gardirop Sistemi / Sliding Wardrobe System | Silver | 2 Kapak / 1 Set | 6 | 144 | - | - |
| 102-8323-1200 | Sürme Gardirop Sistemi 3. Kapak / Sliding Wardrobe System 3. Door | Silver | 1 Kapak / 1 Kit | 8 | 400 | - | - |
| 150-7234-1410 | Alüminyum Üst Ray Profili / Aluminium Top Rail Profile | Eloksal / Mat Anodized | mt. | - | - | 2,0 2,5 3,0 | 6 ad/pcs |
| 150-7520-1410 | Alüminyum Alt Ray Profili / Aluminium Bottom Rail Profile | Eloksal / Mat Anodized | mt. | - | - | 2,0 2,5 3,0 | 30 ad/pcs |
| 150-7102-1410 | Alüminyum Alt Ray Profili / Aluminium Bottom Rail Profile | Eloksal / Mat Anodized | mt. | - | - | - | 20 ad/pcs |
| 150-1400-1420 | Alüminyum Kulp Profili / Aluminium Handle Profile | Parlak / Bright | mt. | - | - | 2,70 | 10 ad/pcs |
| 150-1410-1420 | Alüminyum Kulp Profili / Aluminium Handle Profile | Parlak / Bright | mt. | - | - | 2,70 | 10 ad/pcs |
| 150-1420-1420 | Alüminyum Kapama Profili / Aluminium Closure Profile | Parlak / Bright | mt. | - | - | - | 10 ad/pcs |

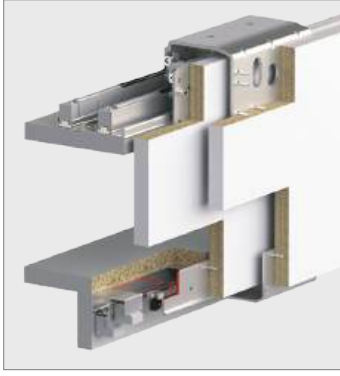

Yavaşlatıcı Alternatifi / Soft Closer Alternative

117-6820-1600 <<>> 117-6840-1600 <<>> 117-6666-1610 >>>

117-6710-1610 >>>



102-8080 İç Kapak 1 Takım İçeriği / Internal Door 1 Kit Includes



102-8084 Dış Kapak 1 Takım İçeriği / External Door 1 Kit Includes



Ray Profilleri / Rail Profiles

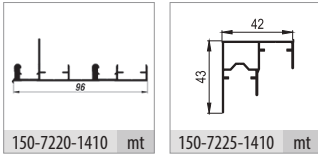

Kulp Profilleri / Handle Profiles

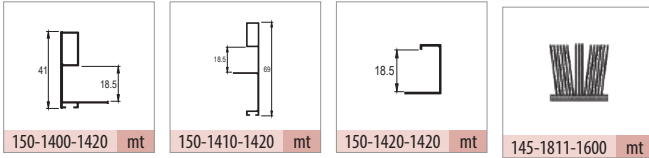

Teknik Detay / Technical Detail

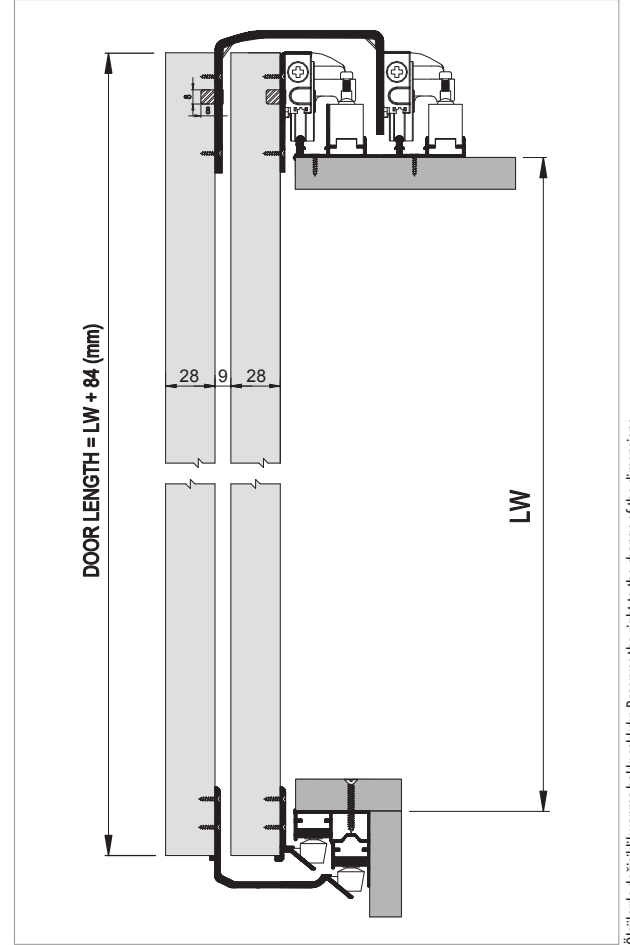

Ölçülerde değişiklik yapma hakkı saklıdır. Reserves the right to the change of the dimensions.

| Kod / Code No | Açıklama / Description | Renk / Colour | Birim / Unit | | | Profil mt. / Profiles mt. | | | Bağ / Bnd. |
|---------------|--|------------------------|-----------------|-----|-------|---------------------------|------|-----|------------|
| 102-8080-1200 | Sürme Gardirop Sistemi İç Kapak / Sliding Wardrobe System Internal Door | Silver | 1 Kapak / 1 Kit | 12 | 384 | - | - | - | - |
| 102-8084-1200 | Sürme Gardirop Sistemi Dış Kapak / Sliding Wardrobe System External Door | Silver | 1 Kapak / 1 Kit | 12 | 216 | - | - | - | - |
| 117-6820-1600 | 80 kg Yavaşlatıcı Mekanizma / 80 kg Soft Closer Mechanism | Gri / Grey | 1 Kapak / 1 Kit | 24 | 576 | - | - | - | - |
| 150-7220-1410 | Alüminyum Üst Ray Profili / Aluminium Top Rail Profile | Eloksal / Mat Anodized | mt. | - | - | 2,0 | 2,5 | 3,0 | 6 ad/pcs |
| 150-7225-1410 | Alüminyum Alt Ray Profili / Aluminium Bottom Rail Profile | Eloksal / Mat Anodized | mt. | - | - | 2,0 | 2,5 | 3,0 | 6 ad/pcs |
| 150-1400-1420 | Alüminyum Kulp Profili / Aluminium Handle Profile | Parlak / Bright | mt. | - | - | - | 2,70 | - | 10 ad/pcs |
| 150-1410-1420 | Alüminyum Kulp Profili / Aluminium Handle Profile | Parlak / Bright | mt. | - | - | - | 2,70 | - | 10 ad/pcs |
| 150-1420-1420 | Alüminyum Kapama Profili / Aluminium Closure Profile | Parlak / Bright | mt. | - | - | - | - | 3,0 | 10 ad/pcs |
| 145-1811-1600 | Kıl Fital / Ec-Wf Hair Wick | Gri / Grey | mt. | 300 | 7.200 | - | - | - | - |

TopSlide 8040

70 KG SÜRME GARDIROP SİSTEMİ • SLIDING WARDROBE SYSTEM

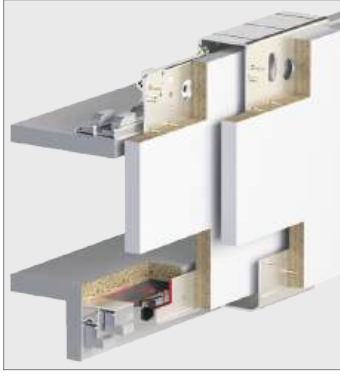

Yavaşlatıcı Alternatifi / Soft Closer Alternative

117-6666-1610 ►► 117-6710-1610 ►►



102-8040 İç Kapak 1 Takım İçeriği / Internal Door 1 Kit Includes



102-8042 Dış Kapak 1 Takım İçeriği / External Door 1 Kit Includes



Ray Profilleri / Rail Profiles

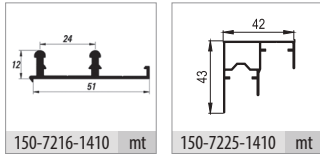

Kulp Profilleri / Handle Profiles

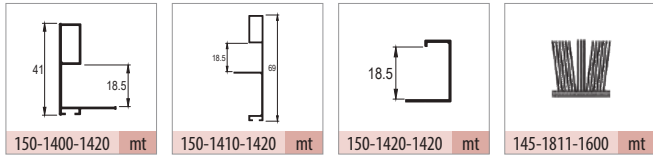

Teknik Detay / Technical Detail

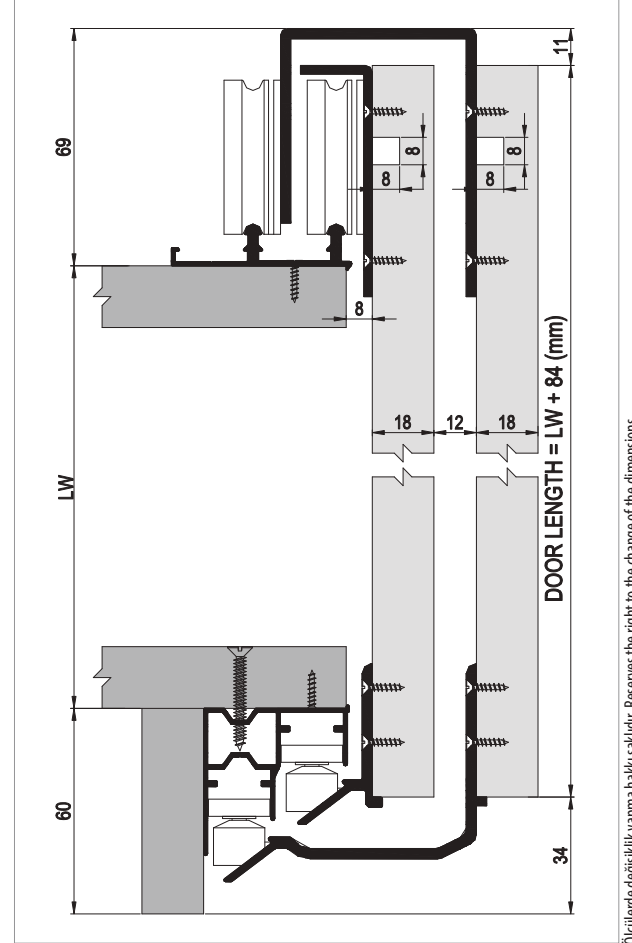

Ölçülerde değişiklik yapma hakkı saklıdır. Reserves the right to the change of the dimensions.

| Kod / Code No | Açıklama / Description | Renk / Colour | Birim / Unit | | | Profil mt. / Profiles mt. | | | Bağ / Bnd. |
|---------------|--|------------------------|-----------------|-----|-------|---------------------------|------|-----|------------|
| 102-8040-1200 | Sürme Gardırop Sistemi İç Kapak / Sliding Wardrobe System Internal Door | Silver | 1 Kapak / 1 Kit | 16 | 384 | - | - | - | - |
| 102-8042-1200 | Sürme Gardırop Sistemi Dış Kapak / Sliding Wardrobe System External Door | Silver | 1 Kapak / 1 Kit | 12 | 288 | - | - | - | - |
| 150-7216-1410 | Alüminyum Üst Ray Profili / Aluminium Top Rail Profile | Eloksal / Mat Anodized | mt. | - | - | 2,0 | 2,5 | 3,0 | 6 ad/pcs |
| 150-7225-1410 | Alüminyum Alt Ray Profili / Aluminium Bottom Rail Profile | Eloksal / Mat Anodized | mt. | - | - | 2,0 | 2,5 | 3,0 | 6 ad/pcs |
| 150-1400-1420 | Alüminyum Kulp Profili / Aluminium Handle Profile | Parlak / Bright | mt. | - | - | - | 2,70 | - | 10 ad/pcs |
| 150-1410-1420 | Alüminyum Kulp Profili / Aluminium Handle Profile | Parlak / Bright | mt. | - | - | - | 2,70 | - | 10 ad/pcs |
| 150-1420-1420 | Alüminyum Kapama Profili / Aluminium Closure Profile | Parlak / Bright | mt. | - | - | - | - | 3,0 | 10 ad/pcs |
| 145-1811-1600 | Kıl Fital / Ec-Wf Hair Wick | Gri / Grey | mt. | 300 | 7.200 | - | - | - | - |

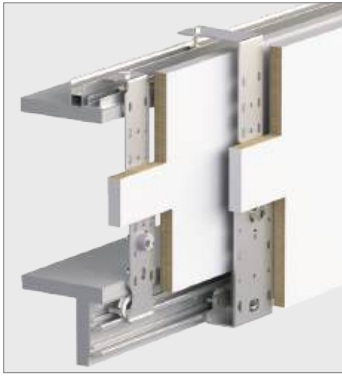

Yavaşlatıcı Alternatifi / Soft Closer Alternative

117-6666-1610 ►► 117-6710-1610 ►►



102-8010 İç Kapak 1 Takım İçeriği / Internal Door 1 Kit Includes

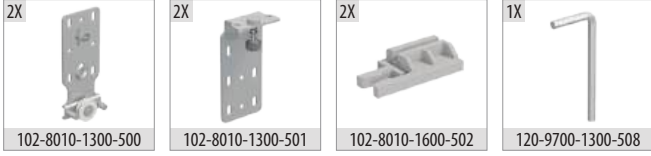

102-8012 Dış Kapak 1 Takım İçeriği / External Door 1 Kit Includes

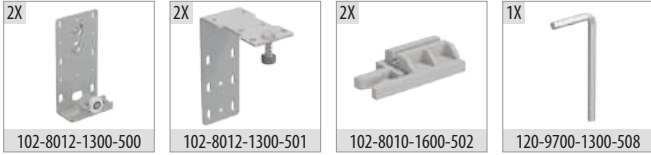

Ray Profilleri / Rail Profiles

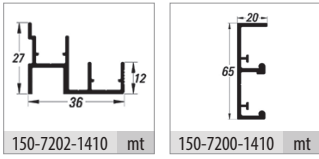

Kulp Profilleri / Handle Profiles

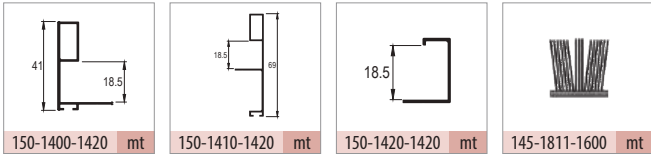

Teknik Detay / Technical Detail

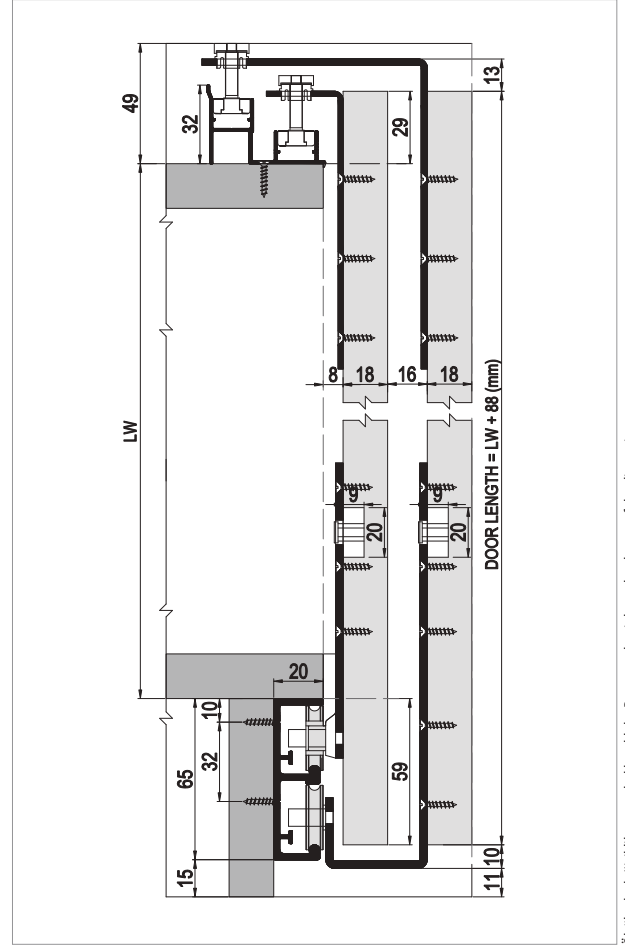

Ölçülerde değişiklik yapma hakkı saklıdır. Reserves the right to the change of the dimensions.

| Kod / Code No | Açıklama / Description | Renk / Colour | Birim / Unit | | | Profil mt. / Profiles mt. | Bağ / Bnd. |
|---------------|--|------------------------|-----------------|-----|-------|---------------------------|---------------|
| 102-8010-1300 | Sürme Gardırop Sistemi İç Kapak / Sliding Wardrobe System Internal Door | Galvaniz / Galvanized | 1 Kapak / 1 Kit | 24 | 576 | - | - |
| 102-8012-1300 | Sürme Gardırop Sistemi Dış Kapak / Sliding Wardrobe System External Door | Galvaniz / Galvanized | 1 Kapak / 1 Kit | 8 | 256 | - | - |
| 150-7202-1410 | Alüminyum Üst Ray Profili / Aluminium Top Rail Profile | Eloksal / Mat Anodized | mt. | - | - | - | 3,0 6 ad/pcs |
| 150-7200-1410 | Alüminyum Alt Ray Profili / Aluminium Bottom Rail Profile | Eloksal / Mat Anodized | mt. | - | - | - | 3,0 6 ad/pcs |
| 150-1400-1420 | Alüminyum Kulp Profili / Aluminium Handle Profile | Parlak / Bright | mt. | - | - | 2,70 | - 10 ad/pcs |
| 150-1410-1420 | Alüminyum Kulp Profili / Aluminium Handle Profile | Parlak / Bright | mt. | - | - | 2,70 | - 10 ad/pcs |
| 150-1420-1420 | Alüminyum Kapama Profili / Aluminium Closure Profile | Parlak / Bright | mt. | - | - | - | 3,0 10 ad/pcs |
| 145-1811-1600 | Kıl Fitol / Ec-Wf Hair Wick | Gri / Grey | mt. | 300 | 7.200 | - | - |

TopSlide 7320

60 KG SÜRME GARDİROP SİSTEMİ • SLIDING WARDROBE SYSTEM

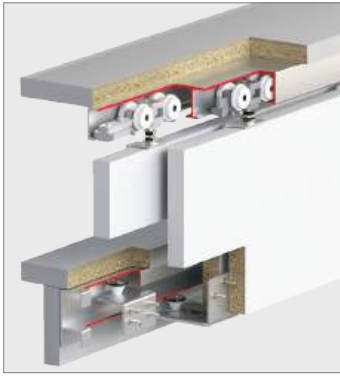

Yavaşlatıcı Alternatifi / Soft Closer Alternative

117-6666-1610 ►► 117-6710-1610 ►►



102-7320 İç Kapak 1 Takım İçeriği / Internal Door 1 Kit Includes



102-7322 Dış Kapak 1 Takım İçeriği / External Door 1 Kit Includes



Ray Profilleri / Rail Profiles

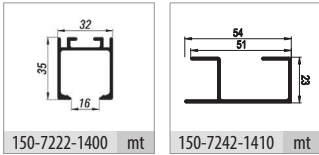

Kulp Profilleri / Handle Profiles

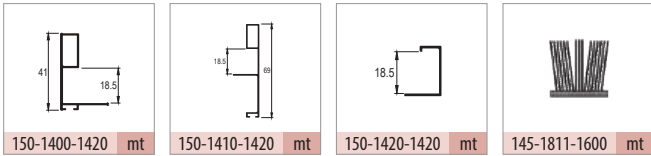

Teknik Detay / Technical Detail

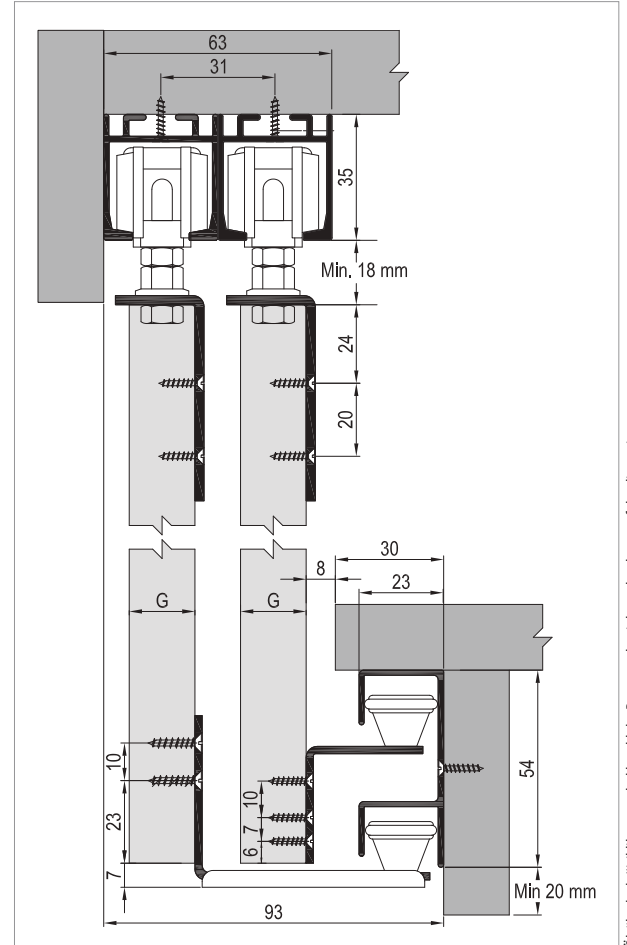

Ölçülerde değişiklik yapma hakkı saklıdır. Reserves the right to the change of the dimensions.

| Kod / Code No | Açıklama / Description | Renk / Colour | Birim / Unit | | | Profil mt. / Profiles mt. | Bağ / Bnd. |
|---------------|--|------------------------|-----------------|-----|-------|---------------------------|------------|
| 102-7320-1600 | Sürme Gardırop Sistemi İç Kapak / Sliding Wardrobe System Internal Door | Galvaniz / Galvanized | 1 Kapak / 1 Kit | 24 | 768 | - | - |
| 102-7322-1600 | Sürme Gardırop Sistemi Dış Kapak / Sliding Wardrobe System External Door | Galvaniz / Galvanized | 1 Kapak / 1 Kit | 24 | 768 | - | - |
| 150-7222-1400 | Alüminyum Üst Ray Profili / Aluminium Top Rail Profile | Pres / Uncoated | mt. | - | - | 2,0 | 3,0 |
| 150-7242-1410 | Alüminyum Alt Ray Profili / Aluminium Bottom Rail Profile | Eloksal / Mat Anodized | mt. | - | - | 2,0 | 3,0 |
| 150-1400-1420 | Alüminyum Kulp Profili / Aluminium Handle Profile | Parlak / Bright | mt. | - | - | 2,70 | 10 ad/pcs |
| 150-1410-1420 | Alüminyum Kulp Profili / Aluminium Handle Profile | Parlak / Bright | mt. | - | - | 2,70 | 10 ad/pcs |
| 150-1420-1420 | Alüminyum Kapama Profili / Aluminium Closure Profile | Parlak / Bright | mt. | - | - | - | 3,0 |
| 145-1811-1600 | Kıl Fital / Ec-Wf Hair Wick | Gri / Grey | mt. | 300 | 7.200 | - | - |

TopSlide 8030

60 KG SÜRME GARDİROP SİSTEMİ • SLIDING WARDROBE SYSTEM



■ Yavaşlatıcı Alternatifi / Soft Closer Alternative

117-6711-1610 ►►



■ 102-8030 İç Kapak 1 Takım İçeriği / Internal Door 1 Kit Includes



■ 102-8032 Dış Kapak 1 Takım İçeriği / External Door 1 Kit Includes

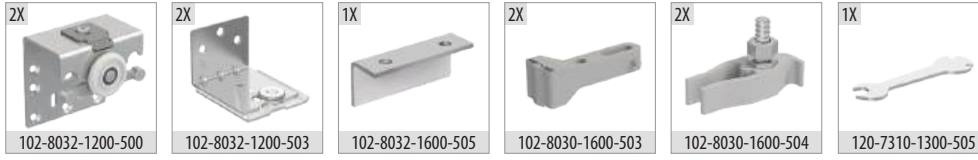

■ Ray Profilleri / Rail Profiles

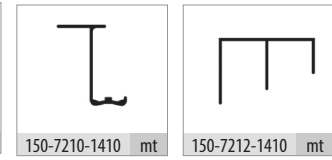

■ 117-6711 Yavaşlatıcı Bağlantı Kiti / Soft Closing Connection Kit

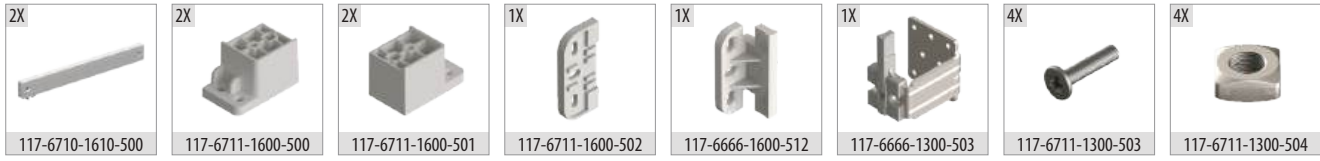

■ Teknik Detay / Technical Detail

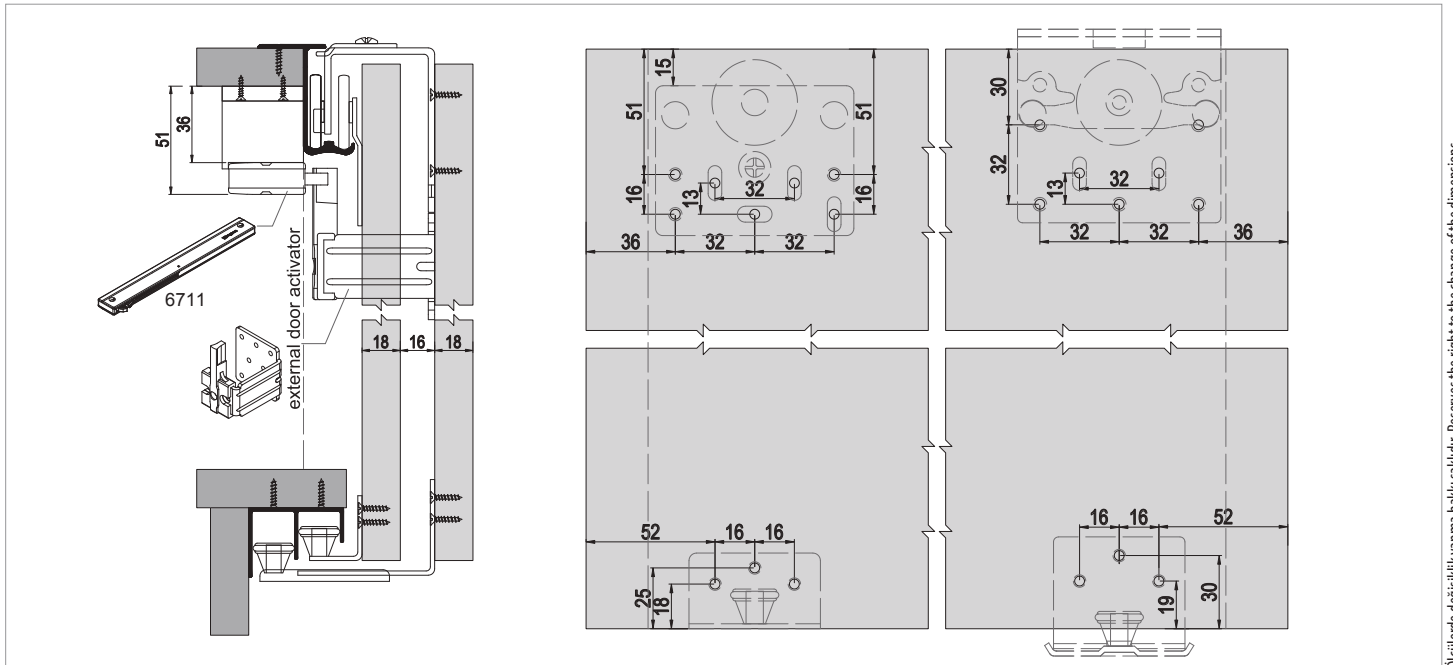

Ölçülerde değişiklik yapma hakkı saklıdır. Reserves the right to the change of the dimensions.

| Kod / Code No | Açıklama / Description | Renk / Colour | Birim / Unit | | | Profil mt. / Profiles mt. | Bağ / Bnd. |
|---------------|--|------------------------|-----------------|----|-----|---------------------------|--------------|
| 102-8030-1300 | Sürme Gardirop Sistemi İç Kapak / Sliding Wardrobe System Internal Door | Silver | 1 Kapak / 1 Kit | 24 | 768 | - | - |
| 102-8032-1200 | Sürme Gardirop Sistemi Dış Kapak / Sliding Wardrobe System External Door | Silver | 1 Kapak / 1 Kit | 24 | 384 | - | - |
| 117-6711-1610 | 100 Kg Yavaşlatıcı Sistem / 100 Kg Soft Closers | Gri / Grey | 1 Takım / 1 Kit | 20 | 480 | - | - |
| 150-7210-1410 | Alüminyum Üst Ray Profili / Aluminium Top Rail Profile | Eloksal / Mat Anodized | mt. | - | - | - | 3,0 6 ad/pcs |
| 150-7212-1410 | Alüminyum Alt Ray Profili / Aluminium Bottom Rail Profile | Eloksal / Mat Anodized | mt. | - | - | - | 3,0 6 ad/pcs |

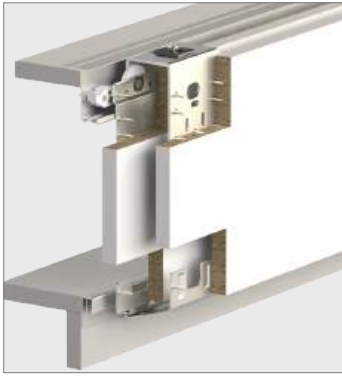

Yavaşlatıcı Alternatifi / Soft Closer Alternative

117-6711-1610 ►►



102-8400 İç Kapak 1 Takım İçeriği / Internal Door 1 Kit Includes

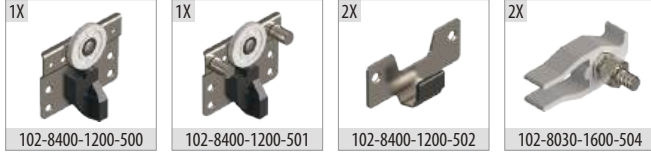

102-8402 Dış Kapak 1 Takım İçeriği / External Door 1 Kit Includes

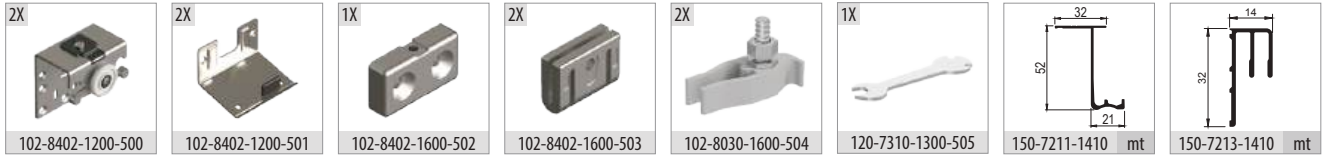

117-6711 Yavaşlatıcı Bağlantı Kiti / Soft Closing Connection Kit

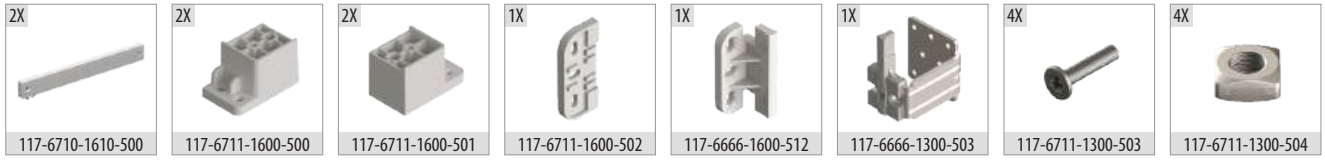

Teknik Detay / Technical Detail

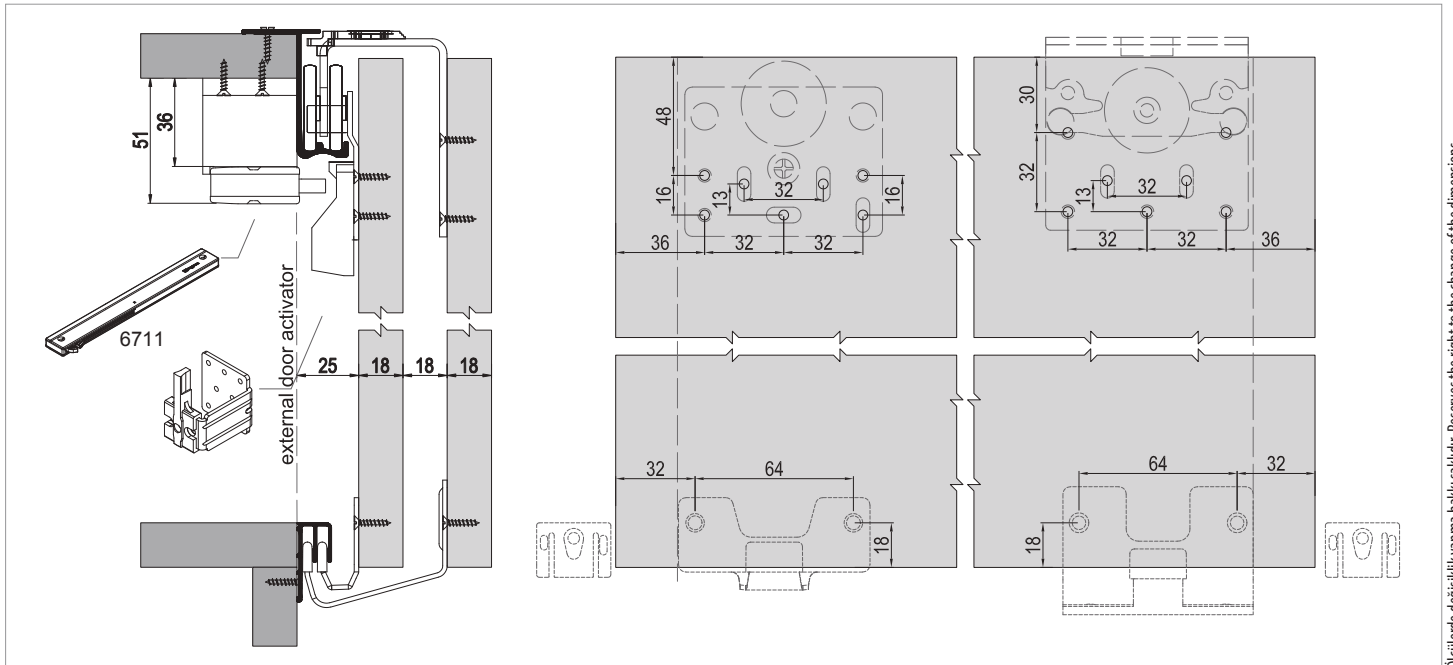

Ölçülerde değişiklik yapma hakkı saklıdır. Reserves the right to the change of the dimensions.

| Kod / Code No | Açıklama / Description | Renk / Colour | Birim / Unit | | | Profil mt. / Profiles mt. | Bağ / Bnd. |
|---------------|--|------------------------|-----------------|----|-----|---------------------------|--------------|
| 102-8400-1300 | Sürme Gardirop Sistemi İç Kapak / Sliding Wardrobe System Internal Door | Silver | 1 Kapak / 1 Kit | 24 | 768 | - | - |
| 102-8402-1200 | Sürme Gardirop Sistemi Dış Kapak / Sliding Wardrobe System External Door | Silver | 1 Kapak / 1 Kit | 12 | 384 | - | - |
| 117-6711-1610 | 100 Kg Yavaşlatıcı Sistem / 100 Kg Soft Closers | Gri / Grey | 1 Takım / 1 Kit | 20 | 480 | - | - |
| 150-7211-1410 | Alüminyum Üst Ray Profili / Aluminium Top Rail Profile | Eloksal / Mat Anodized | mt. | - | - | - | 3,0 6 ad/pcs |
| 150-7213-1410 | Alüminyum Alt Ray Profili / Aluminium Bottom Rail Profile | Eloksal / Mat Anodized | mt. | - | - | - | 3,0 6 ad/pcs |

TopSlide SRG 190

70 KG SÜRME GARDIROP SİSTEMİ • SLIDING WARDROBE SYSTEM

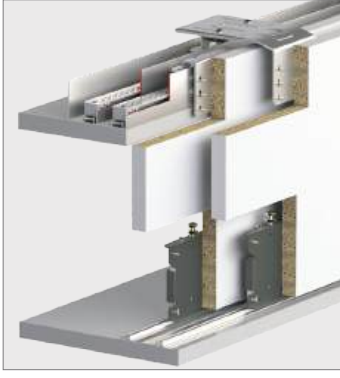

Bilgi / Information

- 1 Kutu İçeriği : 1 iç kapak + 1 dış kapak + 4 ad yavaşlatıcı
- In 1 box : 1 internal door + 1 external door + 4 pcs soft closers



102-0190 1 Set İçeriği / 1 Set Includes

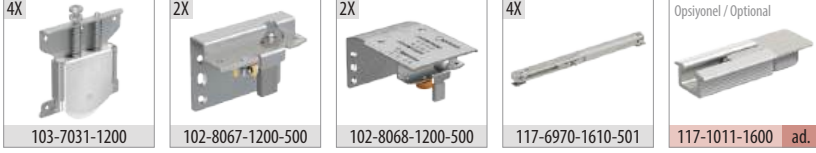

102-0193 Opsiyonel 3. İç Kapak / Optional 3. Internal Door

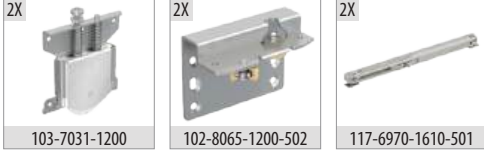

Ray Profilleri / Rail Profiles

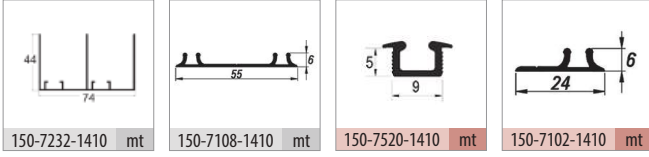

Kulp Profilleri / Handle Profiles

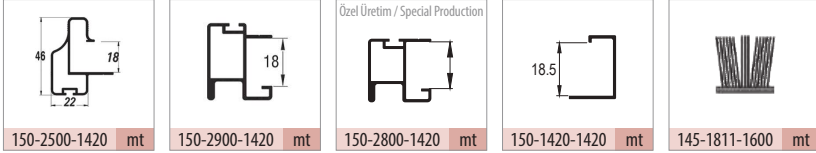

Teknik Detay / Technical Detail

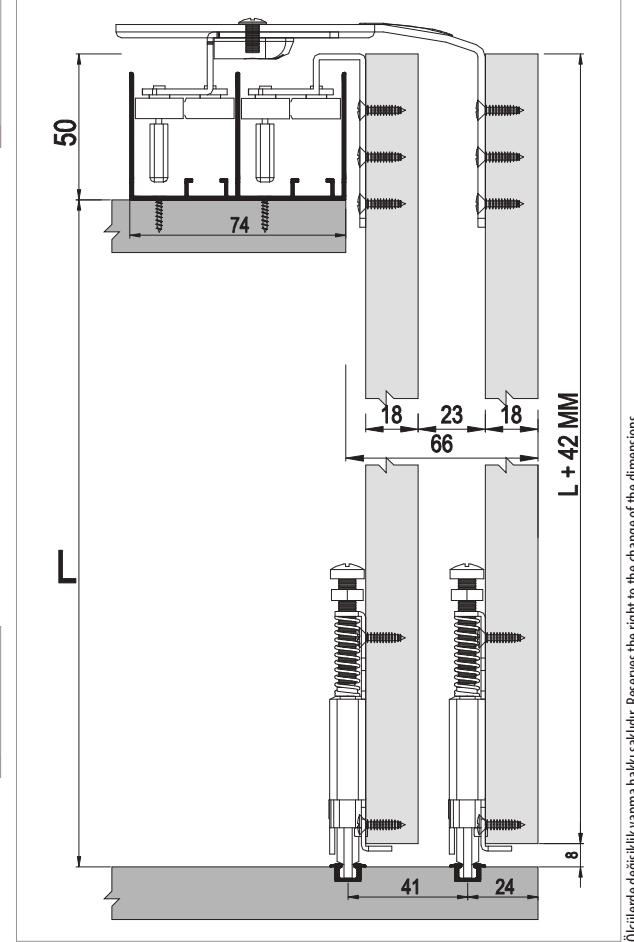

Ölçülerde değişiklik yapma hakkı saklıdır. Reserves the right to the change of the dimensions.

| Kod / Code No | Açıklama / Description | Renk / Colour | Birim / Unit | | | Profil mt. / Profiles mt. | Bağ / Bnd. |
|---------------|---|------------------------|-----------------|-----|-------|---------------------------|------------|
| 102-0190-1200 | SRG 190 - Sürme Gardirop Sistemi / SRG 190 - Sliding Wardrobe System | Silver | 2 Kapak / 1 Set | 12 | 216 | - - - | - |
| 102-0193-1200 | SRG 190 C - Sürme Gardirop Sistemi 3. Kapak / Sliding Wardrobe System 3. Door | Silver | 1 Kapak / 1 Kit | 12 | 360 | - - - | - |
| 145-1811-1600 | Kıl Fital / Ec-Wf Hair Wick | Gri / Grey | mt. | 300 | 7.200 | - - - | - |
| 150-7232-1410 | Alüminyum Üst Ray Profili / Aluminium Top Rail Profile | Eloksal / Mat Anodized | mt. | - | - | 2,0 2,5 3,0 | 6 ad/pcs |
| 150-7108-1410 | Alüminyum Alt Ray Profili / Aluminium Bottom Rail Profile | Eloksal / Mat Anodized | mt. | - | - | 2,0 2,5 3,0 | 12 ad/pcs |
| 150-7520-1410 | Alüminyum Alt Ray Profili / Aluminium Bottom Rail Profile | Eloksal / Mat Anodized | mt. | - | - | - - 3,0 | 30 ad/pcs |
| 150-7102-1410 | Alüminyum Alt Ray Profili / Aluminium Bottom Rail Profile | Eloksal / Mat Anodized | mt. | - | - | - - 3,0 | 20 ad/pcs |
| 150-2500-1420 | Alüminyum Kulp Profili / Aluminium Handle Profile | Parlak / Bright | mt. | - | - | 2,0 - 3,0 | 6 ad/pcs |
| 150-2900-1420 | Alüminyum Kulp Profili / Aluminium Handle Profile | Parlak / Bright | mt. | - | - | 2,0 2,5 3,0 | 6 ad/pcs |
| 150-2800-1420 | Alüminyum Kulp Profili / Aluminium Handle Profile | Parlak / Bright | mt. | - | - | - - 3,0 | 6 ad/pcs |
| 150-1420-1420 | Alüminyum Kapama Profili / Aluminium Closure Profile | Parlak / Bright | mt. | - | - | - - 3,0 | 10 ad/pcs |

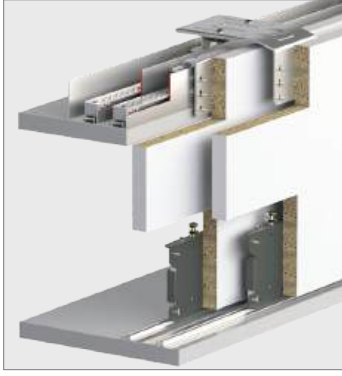

Bilgi / Information

- 1 Kutu İçeriği : 1 iç kapak + 1 dış kapak + 4 ad yavaşlatıcı
- In 1 box : 1 internal door + 1 external door + 4 pcs soft closers



102-0195 1 Set İçeriği / 1 Set Includes

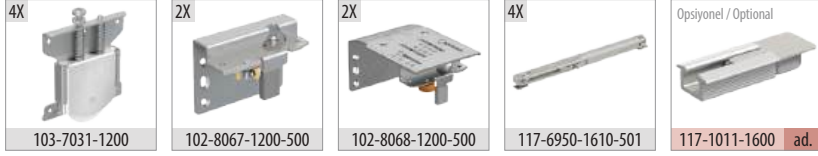

102-0196 Opsiyonel 3. İç Kapak / Optional 3. Internal Door



Ray Profilleri / Rail Profiles

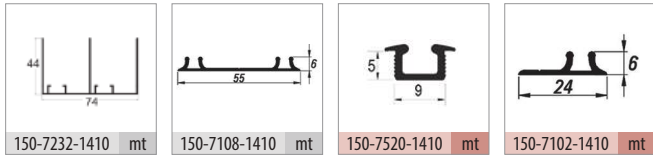

Kulp Profilleri / Handle Profiles

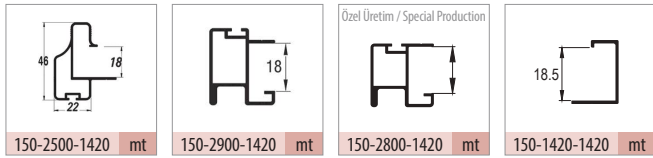

Teknik Detay / Technical Detail

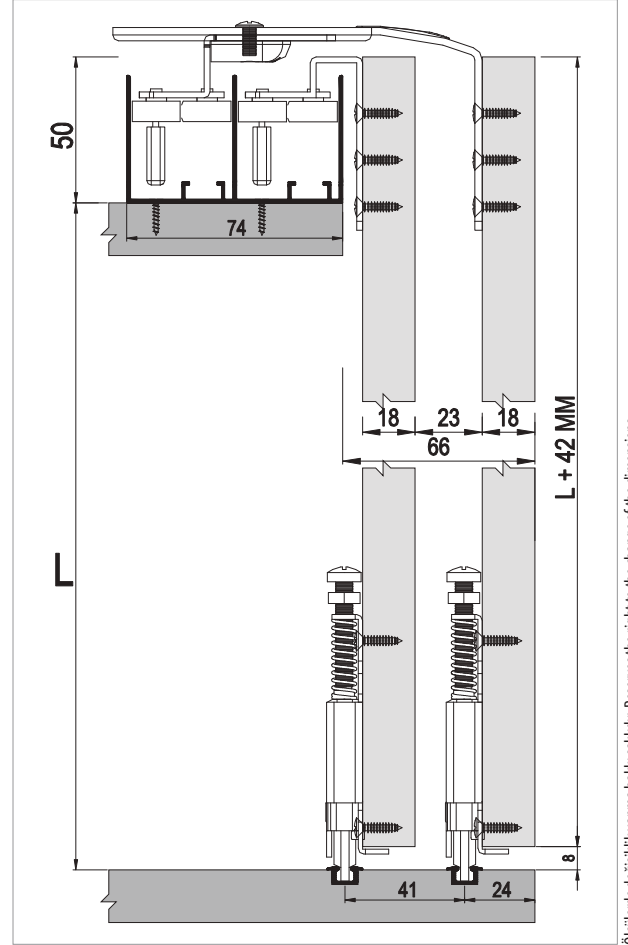

Ölçülerde değişiklik yapma hakkı saklıdır. Reserves the right to the change of the dimensions.

| Kod / Code No | Açıklama / Description | Renk / Colour | Birim / Unit | | | Profil mt. / Profiles mt. | Bağ / Bnd. |
|---------------|---|------------------------|-----------------|-----|-------|---------------------------|------------|
| 102-0195-1200 | SRG 195 - Sürme Gardirop Sistemi / SRG 195 - Sliding Wardrobe System | Silver | 2 Kapak / 1 Set | 12 | 216 | - - - | - |
| 102-0196-1200 | SRG 195 C - Sürme Gardirop Sistemi 3. Kapak / Sliding Wardrobe System 3. Door | Silver | 1 Kapak / 1 Kit | 12 | 360 | - - - | - |
| 145-1811-1600 | Kıl Fital / Ec-Wf Hair Wick | Gri / Grey | mt. | 300 | 7.200 | - - - | - |
| 150-7232-1410 | Alüminyum Üst Ray Profili / Aluminium Top Rail Profile | Eloksal / Mat Anodized | mt. | - | - | 2,0 2,5 3,0 | 6 ad/pcs |
| 150-7108-1410 | Alüminyum Alt Ray Profili / Aluminium Bottom Rail Profile | Eloksal / Mat Anodized | mt. | - | - | 2,0 2,5 3,0 | 12 ad/pcs |
| 150-7520-1410 | Alüminyum Alt Ray Profili / Aluminium Bottom Rail Profile | Eloksal / Mat Anodized | mt. | - | - | - - 3,0 | 30 ad/pcs |
| 150-7102-1410 | Alüminyum Alt Ray Profili / Aluminium Bottom Rail Profile | Eloksal / Mat Anodized | mt. | - | - | - - 3,0 | 20 ad/pcs |
| 150-2500-1420 | Alüminyum Kulp Profili / Aluminium Handle Profile | Parlak / Bright | mt. | - | - | 2,0 - 3,0 | 6 ad/pcs |
| 150-2900-1420 | Alüminyum Kulp Profili / Aluminium Handle Profile | Parlak / Bright | mt. | - | - | 2,0 2,5 3,0 | 6 ad/pcs |
| 150-2800-1420 | Alüminyum Kulp Profili / Aluminium Handle Profile | Parlak / Bright | mt. | - | - | - - 3,0 | 6 ad/pcs |
| 150-1420-1420 | Alüminyum Kapama Profili / Aluminium Closure Profile | Parlak / Bright | mt. | - | - | - - 3,0 | 10 ad/pcs |

Group 103

Multiline®

Sürme Kapak Serisi

Sliding Door Series



Bu serideki tüm ürünleri incelemek için QR kodu okutabilirsiniz.

You can search the QR code to see all the products in these series.



Multiline **1**



Multiline **2**



Multiline **3**



Multiline **4**



Multiline **5**



Multiline **7**



Multiline **8**



Multiline **9**



Multiline **10**



Multiline **11**



Multiline **12**



Multiline **13**



Multiline **14**



Multiline **15**



Multiline **SRG 100**



Multiline **SRG 300**



Multiline **SRG 110**

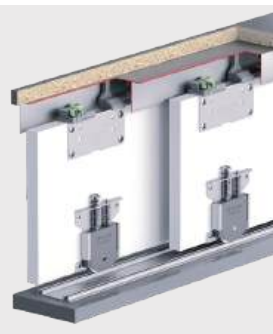

Multiline **SRG 115**



Multiline **SRG 210**

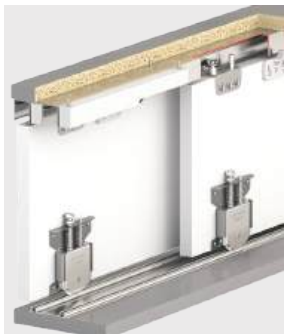

Multiline **SRG 120**



Multiline **SRG 125**



Multiline **SRG 130**

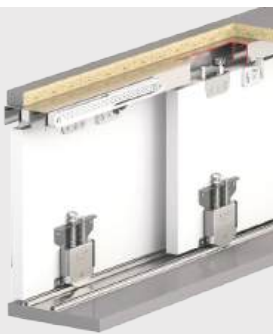

Multiline **SRG 135**

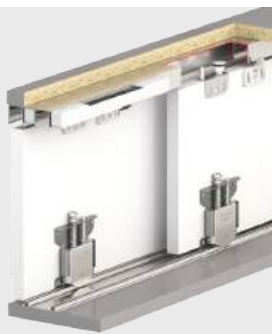

Multiline **SRG 140**



Multiline **SRG 145**



Multiline **7036**

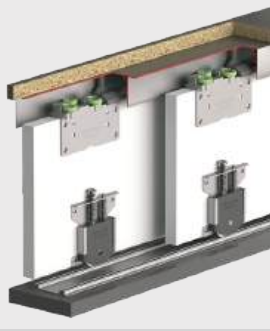

Multiline **7038**



Multiline **7030**



Multiline **7031**



Multiline **7032**



Multiline **7012**



Multiline **7010**



Multiline **7011**



Multiline **7020**



Multiline **7060**



Multiline **7055**



Multiline **6400**



Multiline **7040**

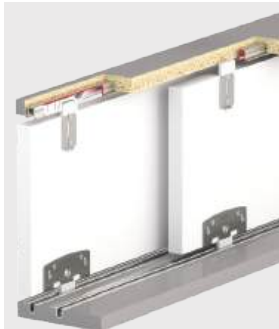

Multiline **7045**



Multiline **6500**



Multiline **6510**



Multiline **6000**



Multiline **0171**



Multiline **6600**



Multiline **6320**



Multiline **6100**



Multiline **7601**

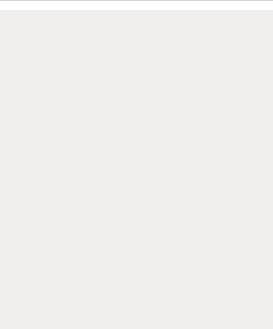

Multiline 1

50 KG SÜRME KAPAK SİSTEMİ • SLIDING DOOR SYSTEM

Yeni Ürün
New Product



Bilgi / Information

- 1 Kutu İçeriği : 2 Kapak Yavaşlatıcı Mekanizma
- In 1 box : 2 Door Mechanism with Soft Closers

Yavaşlatıcı Alternatifi / Soft Closer Alternative

- Sistem üzerinde entegre yavaşlatıcı mevcuttur.
- The system has integrated soft closer.



103-1010 1 Set İçeriği / 1 Set Includes

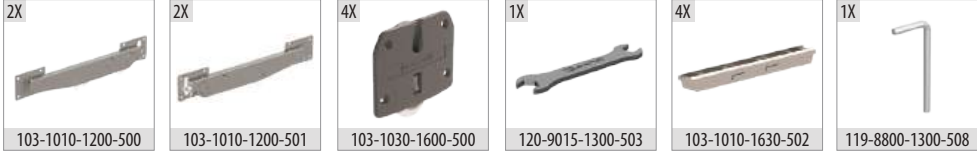

Ray Profilleri / Rail Profiles

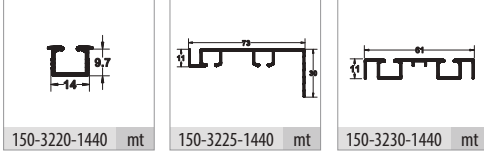

Kulp Profilleri / Handle Profiles

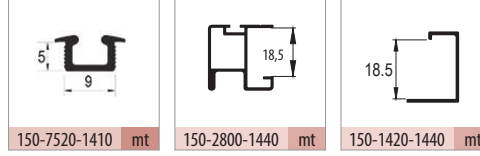

Opsiyonel / Optional

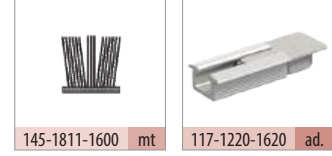

Teknik Detay / Technical Detail

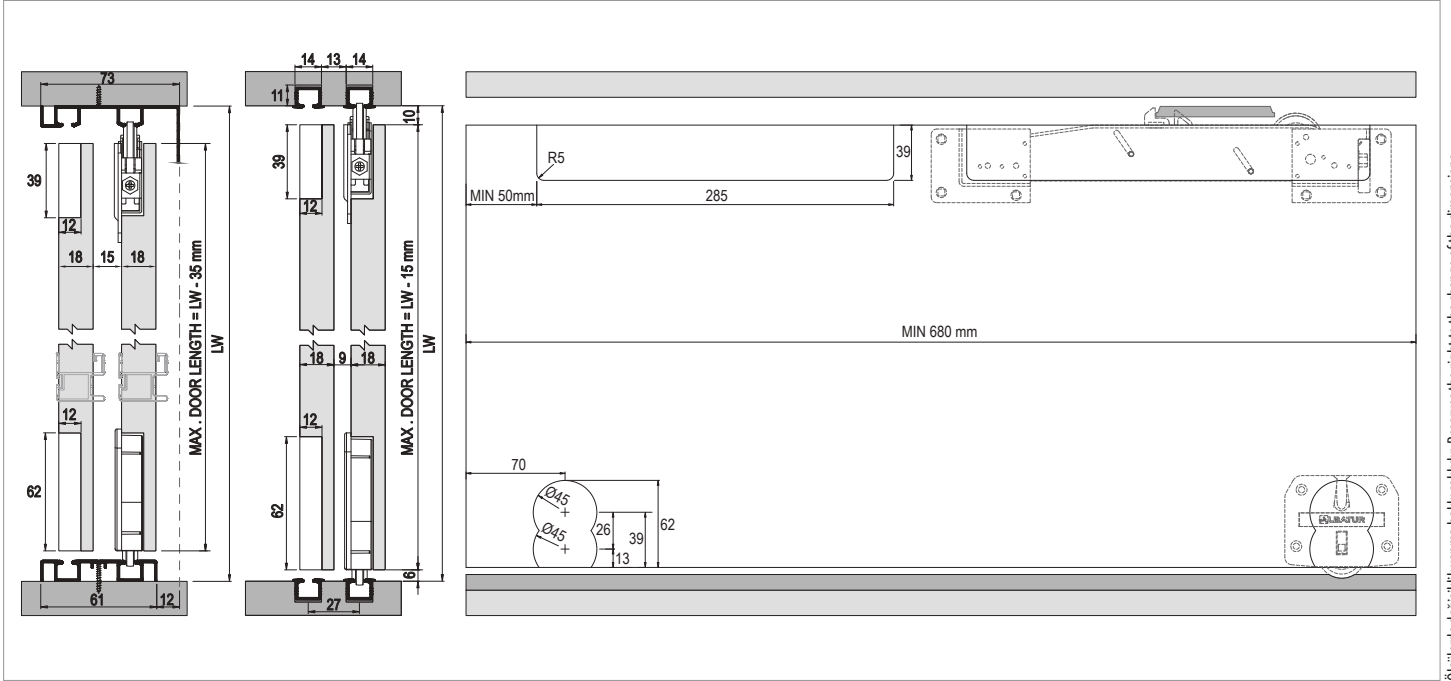

Ölçülerde değişiklik yapma hakkı saklıdır. Reserves the right to the change of the dimensions.

| Kod / Code No | Açıklama / Description | Renk / Colour | Birim / Unit | | | Profil mt. / Profiles mt. | Bağ / Bnd. |
|---------------|---|------------------------------|-----------------|-----|-------|---------------------------|---------------|
| 103-1010-1200 | Multiline 1 - Sürme Gardirop Sistemi / Sliding Wardrobe System | Silver | 2 Kapak / 1 Set | 12 | 360 | - | - |
| 145-1811-1600 | Kıl Fital / Ec-Wf Hair Wick | Gri / Grey | mt. | 300 | 7.200 | - | - |
| 150-3220-1440 | Alüminyum Alt-Üst Ray Profili / Aluminium Bottom-Top Rail Profile | Bronz Parlak / Bronze Bright | mt. | - | - | - | 3,0 20 ad/pcs |
| 150-3225-1440 | Alüminyum Üst Ray Profili / Aluminium Top Rail Profile | Bronz Parlak / Bronze Bright | mt. | - | - | - | 3,0 6 ad/pcs |
| 150-3230-1440 | Alüminyum Alt-Üst Ray Profili / Aluminium Bottom-Top Rail Profile | Bronz Parlak / Bronze Bright | mt. | - | - | - | 3,0 10 ad/pcs |
| 150-7520-1410 | Alüminyum Alt Ray Profili / Aluminium Bottom Rail Profile | Eloksal / Mat Anodized | mt. | - | - | - | 3,0 30 ad/pcs |
| 150-2800-1440 | Alüminyum Kulp Profili / Aluminium Handle Profile | Bronz Parlak / Bronze Bright | mt. | - | - | - | 3,0 6 ad/pcs |
| 150-1420-1440 | Alüminyum Kapama Profili / Aluminium Closure Profile | Bronz Parlak / Bronze Bright | mt. | - | - | - | 3,0 10 ad/pcs |

Multiline 2

50 KG SÜRME KAPAK SİSTEMİ • SLIDING DOOR SYSTEM

Yeni Ürün
New Product



Bilgi / Information

- 1 Kutu İçeriği : 2 Kapak Yavaşlatıcı Mekanizma
- In 1 box : 2 Door Mechanism with Soft Closers

Yavaşlatıcı Alternatifi / Soft Closer Alternative

- Sistem üzerinde entegre yavaşlatıcı mevcuttur.
- The system has integrated soft closer.



103-1020 1 Set İçeriği / 1 Set Includes



Ray Profilleri / Rail Profiles

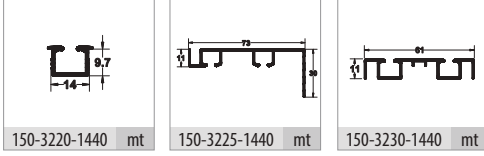

Kulp Profilleri / Handle Profiles

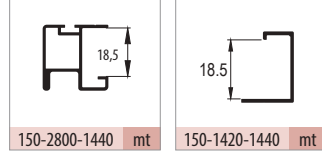

Opsiyonel / Optional

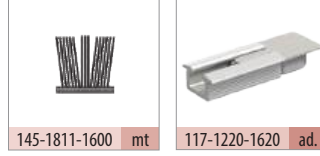

Teknik Detay / Technical Detail

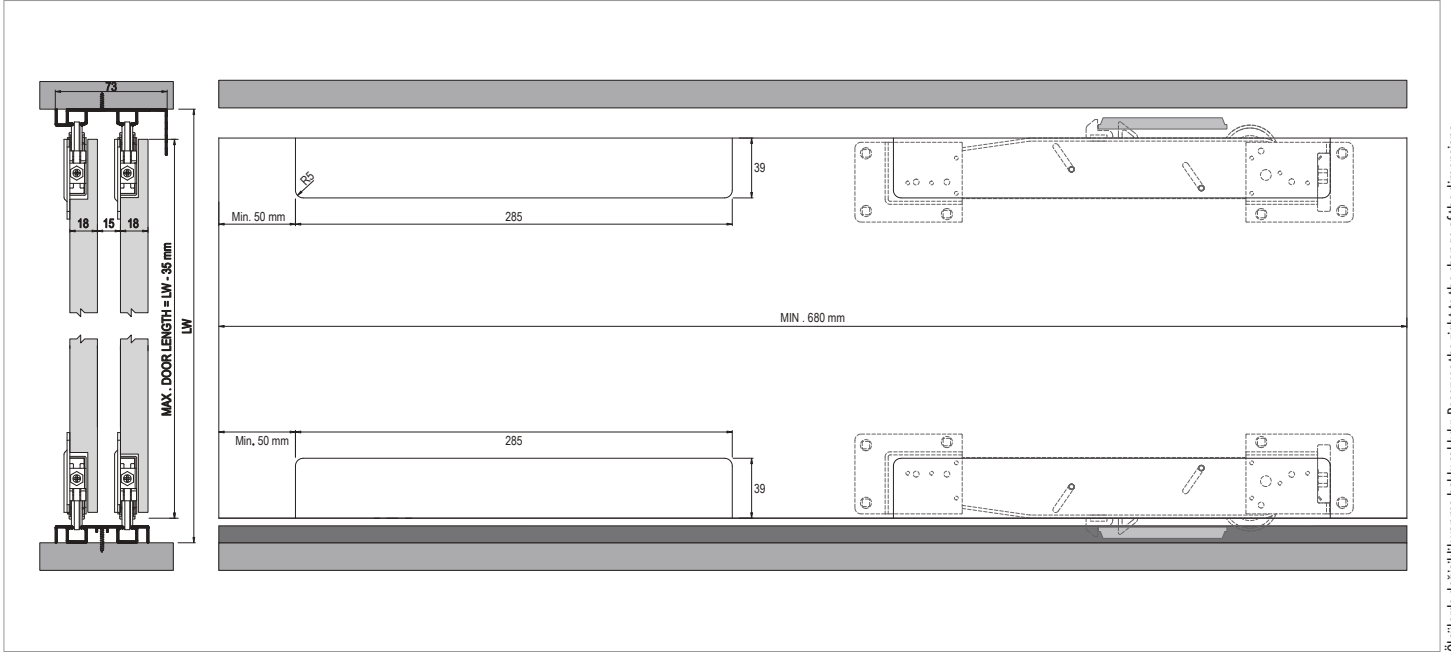

Özelliklerde değişiklik yapma hakkı saklıdır. Reserves the right to the change of the dimensions.

| Kod / Code No | Açıklama / Description | Renk / Colour | Birim / Unit | | | Profil mt. / Profiles mt. | Bağ / Bnd. |
|---------------|---|------------------------------|-----------------|-----|-------|---------------------------|------------|
| 103-1020-1200 | Multiline 2 - Sürme Gardrop Sistemi / Sliding Wardrobe System | Silver | 2 Kapak / 1 Set | 5 | 90 | - - - | - |
| 145-1811-1600 | Kıl Fital / Ec-Wf Hair Wick | Gri / Grey | mt. | 300 | 7.200 | - - - | - |
| 150-3220-1440 | Alüminyum Alt-Üst Ray Profili / Aluminium Bottom-Top Rail Profile | Bronz Parlak / Bronze Bright | mt. | - | - | - - 3,0 | 20 ad/pcs |
| 150-3225-1440 | Alüminyum Üst Ray Profili / Aluminium Top Rail Profile | Bronz Parlak / Bronze Bright | mt. | - | - | - - 3,0 | 6 ad/pcs |
| 150-3230-1440 | Alüminyum Alt-Üst Ray Profili / Aluminium Bottom-Top Rail Profile | Bronz Parlak / Bronze Bright | mt. | - | - | - - 3,0 | 10 ad/pcs |
| 150-2800-1440 | Alüminyum Kulp Profili / Aluminium Handle Profile | Bronz Parlak / Bronze Bright | mt. | - | - | - - 3,0 | 6 ad/pcs |
| 150-1420-1440 | Alüminyum Kapama Profili / Aluminium Closure Profile | Bronz Parlak / Bronze Bright | mt. | - | - | - - 3,0 | 10 ad/pcs |

Multiline 3

40 KG SÜRME KAPAK SİSTEMİ • SLIDING DOOR SYSTEM

Yeni Ürün
New Product



103-1030 1 Set İçeriği / 1 Set Includes Opsiyonel / Optional



Ray Profilleri / Rail Profiles

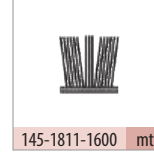
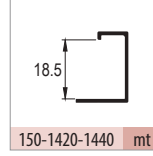
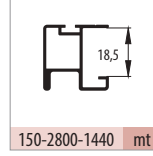
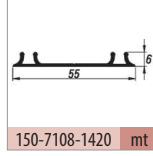
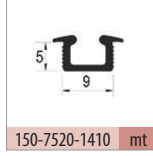
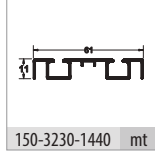
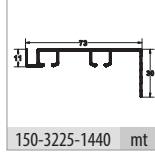
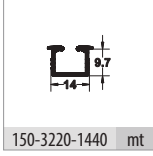

Kulp Profilleri / Handle Profiles

Teknik Detay / Technical Detail

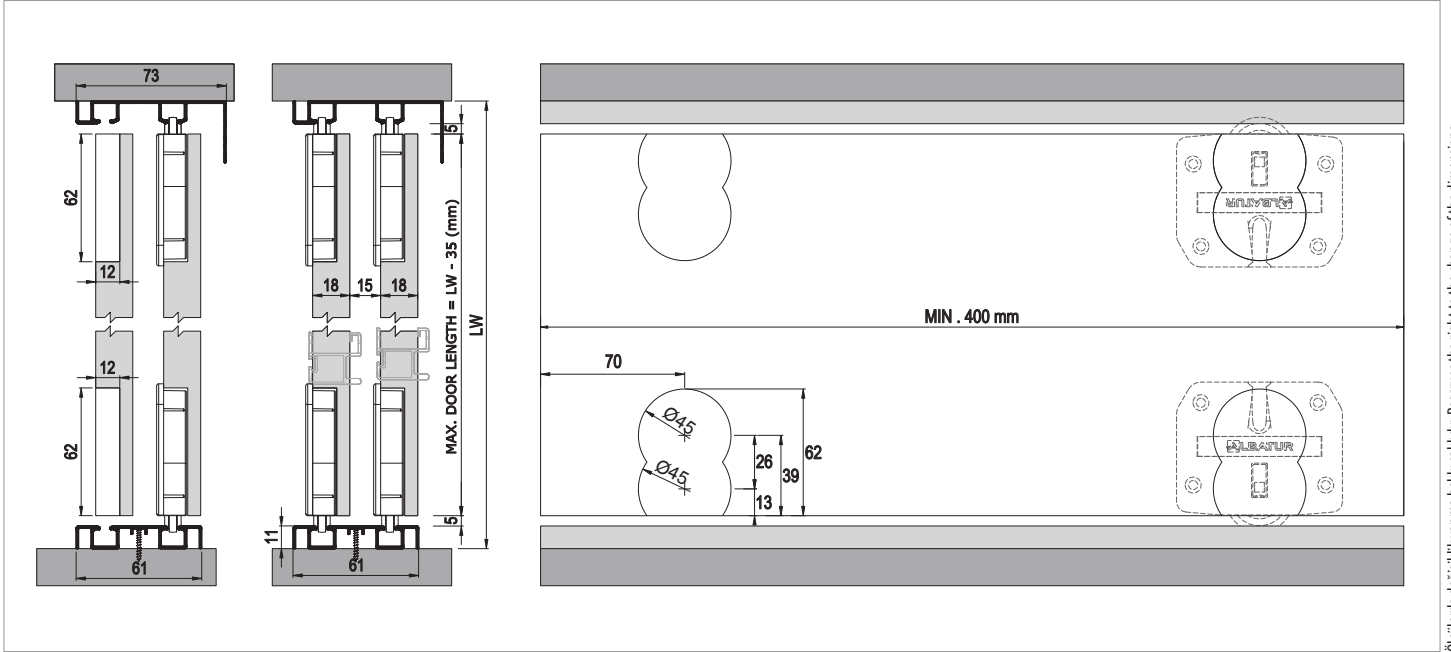

Ölçülerde değişiklik yapma hakkı saklıdır. Reserves the right to the change of the dimensions.

| Kod / Code No | Açıklama / Description | Renk / Colour | Birim / Unit | | | Profil mt. / Profiles mt. | Bağ / Bnd. |
|---------------|---|------------------------------|-----------------|-----|-------|---------------------------|---------------|
| 103-1030-1600 | Multiline 3 - Sürme Gardrop Sistemi / Sliding Wardrobe System | Silver | 2 Kapak / 1 Set | 16 | 512 | - - - | - |
| 145-1811-1600 | Kıl Fitol / Ec-Wf Hair Wick | Gri / Grey | mt. | 300 | 7.200 | - - - | - |
| 150-3220-1440 | Alüminyum Alt-Üst Ray Profili / Aluminium Bottom-Top Rail Profile | Bronz Parlak / Bronze Bright | mt. | - | - | - - - | 3,0 20 ad/pcs |
| 150-3225-1440 | Alüminyum Üst Ray Profili / Aluminium Top Rail Profile | Bronz Parlak / Bronze Bright | mt. | - | - | - - - | 3,0 6 ad/pcs |
| 150-3230-1440 | Alüminyum Alt-Üst Ray Profili / Aluminium Bottom-Top Rail Profile | Bronz Parlak / Bronze Bright | mt. | - | - | - - - | 3,0 10 ad/pcs |
| 150-7108-1420 | Alüminyum Alt Ray Profili / Aluminium Bottom Rail Profile | Parlak / Bright | mt. | - | - | - - - | 3,0 12 ad/pcs |
| 150-7520-1410 | Alüminyum Alt-Üst Ray Profili / Aluminium Bottom-Top Rail Profile | Eloksal / Mat Anodized | mt. | - | - | - - - | 3,0 30 ad/pcs |
| 150-2800-1440 | Alüminyum Kulp Profili / Aluminium Handle Profile | Bronz Parlak / Bronze Bright | mt. | - | - | - - - | 3,0 6 ad/pcs |
| 150-1420-1440 | Alüminyum Kapama Profili / Aluminium Closure Profile | Bronz Parlak / Bronze Bright | mt. | - | - | - - - | 3,0 10 ad/pcs |

Multiline 4

50 KG SÜRME KAPAK SİSTEMİ • SLIDING DOOR SYSTEM

Yeni Ürün
New Product



Bilgi / Information

- 1 Kutu İçeriği : 2 Kapak Mekanizma + 4 Ad Yavaşlatıcı
- In 1 box : 2 Door Mechanism + 4 Pcs Soft Closers



103-1040 1 Set İçeriği / 1 Set Includes

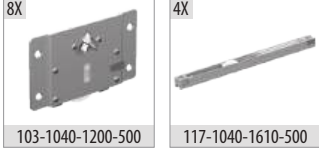

Ray Profilleri / Rail Profiles

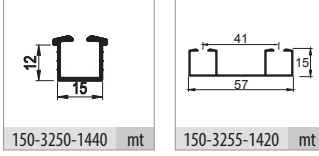

Kulp Profilleri / Handle Profiles

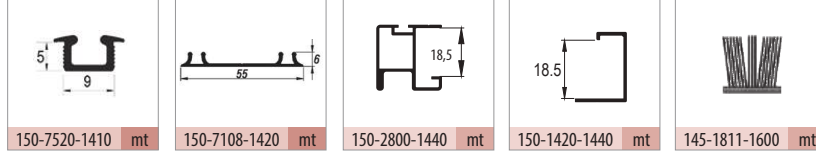

Teknik Detay / Technical Detail

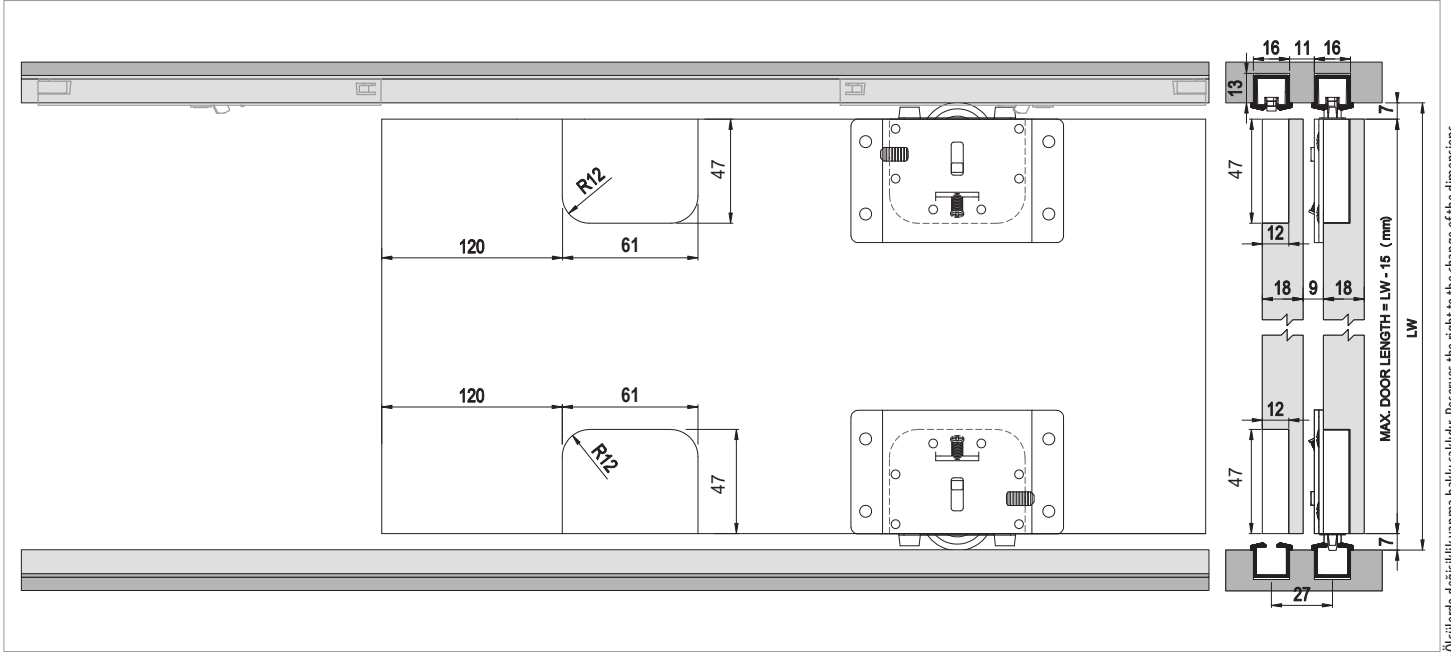

Ölçülerde değişiklik yapma hakkı saklıdır. Reserves the right to the change of the dimensions.

| Kod / Code No | Açıklama / Description | Renk / Colour | Birim / Unit | | | Profil mt. / Profiles mt. | Bağ / Bnd. |
|---------------|---|------------------------------|-----------------|-----|-------|---------------------------|---------------|
| 103-1040-1200 | Multiline 4 - Sürme Gardirop Sistemi / Sliding Wardrobe System | Silver | 2 Kapak / 1 Set | 12 | 360 | - | - |
| 145-1811-1600 | Kıl Fital / Ec-Wf Hair Wick | Gri / Grey | mt. | 300 | 7.200 | - | - |
| 150-3250-1440 | Alüminyum Alt-Üst Ray Profili / Aluminium Bottom-Top Rail Profile | Bronz Parlak / Bronze Bright | mt. | - | - | - | 3,0 4 ad/pcs |
| 150-3255-1420 | Alüminyum Üst Ray Profili / Aluminium Top Rail Profile | Parlak / Bright | mt. | - | - | - | 3,0 12 ad/pcs |
| 150-7108-1420 | Alüminyum Alt Ray Profili / Aluminium Bottom Rail Profile | Parlak / Bright | mt. | - | - | - | 3,0 12 ad/pcs |
| 150-7520-1410 | Alüminyum Alt Ray Profili / Aluminium Bottom Rail Profile | Eloksal / Mat Anodized | mt. | - | - | - | 3,0 30 ad/pcs |
| 150-2800-1440 | Alüminyum Kulp Profili / Aluminium Handle Profile | Bronz Parlak / Bronze Bright | mt. | - | - | - | 3,0 6 ad/pcs |
| 150-1420-1440 | Alüminyum Kapama Profili / Aluminium Closure Profile | Bronz Parlak / Bronze Bright | mt. | - | - | - | 3,0 10 ad/pcs |

Multiline 5

20 KG SÜRME KAPAK SİSTEMİ • SLIDING DOOR SYSTEM

Yeni Ürün
New Product



■ Yavaşlatıcı Alternatifi / Soft Closer Alternative

- Sistem üzerinde entegre yavaşlatıcı mevcuttur.
- The system has integrated soft closer.



■ 103-1050 1 Takım İçeriği / 1 Kit Includes

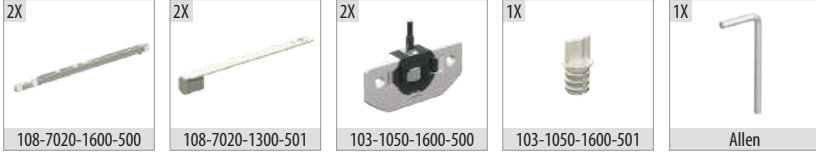

■ Ray Profilleri / Rail Profiles

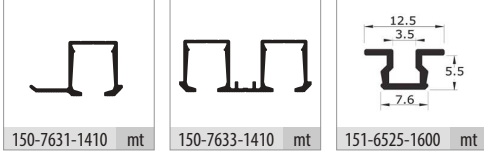

■ Teknik Detay / Technical Detail

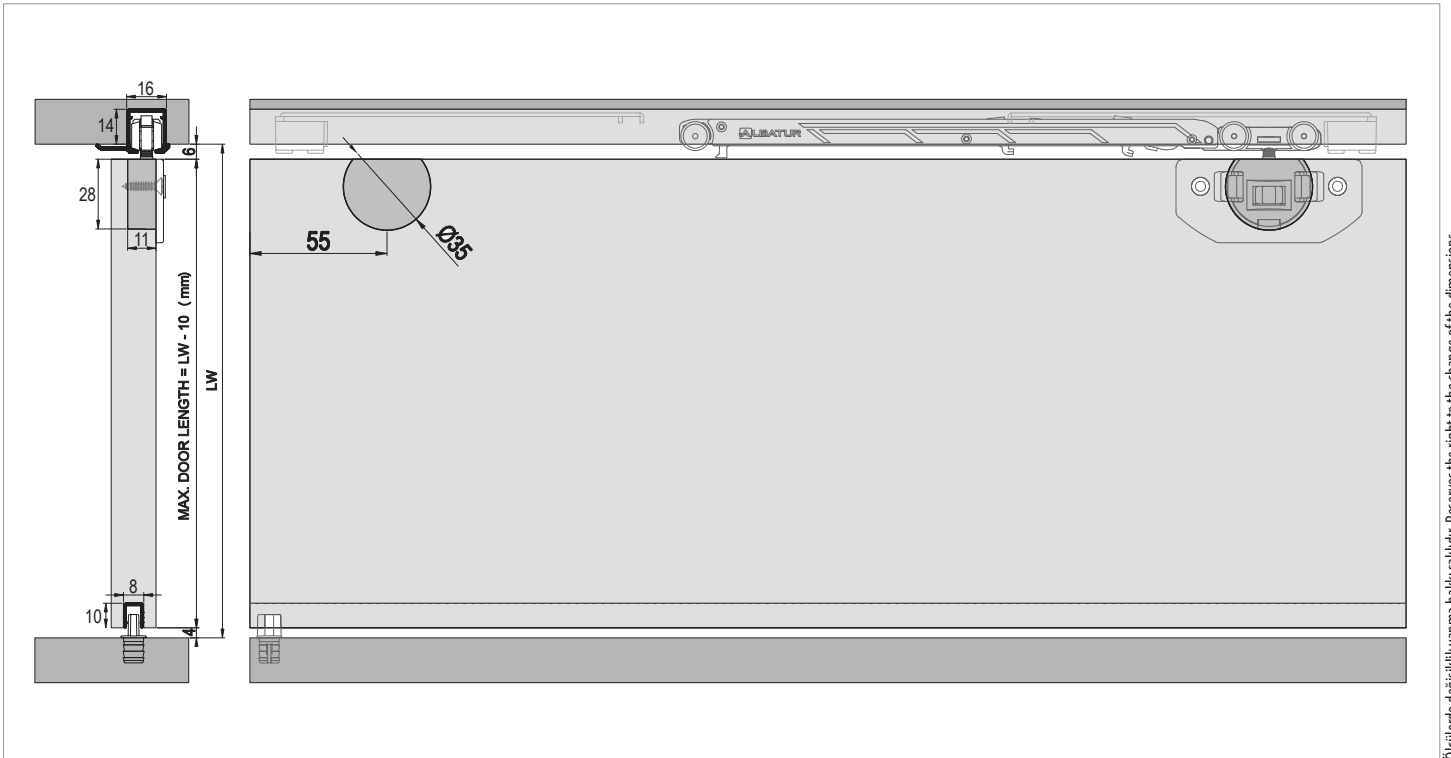

Ölçülerde değişiklik yapma hakkı saklıdır. Reserves the right to the change of the dimensions.

| Kod / Code No | Açıklama / Description | Renk / Colour | Birim / Unit | | | Profil mt. / Profiles mt. | | | Bağ / Bnd. |
|---------------|--|------------------------|-----------------|----|-----|---------------------------|---|-----|------------|
| 103-1050-1600 | Multiline 5 - Sürme Gardirop Sistemi / Sliding Wardrobe System | Gri / Grey | 1 Kapak / 1 Kit | 12 | 360 | - | - | - | - |
| 150-7631-1410 | Alüminyum Üst Ray Profili / Aluminium Top Rail Profile | Eloksal / Mat Anodized | mt. | - | - | - | - | 3,0 | 10 ad/pcs |
| 150-7633-1410 | Alüminyum Üst Ray Profili / Aluminium Top Rail Profile | Eloksal / Mat Anodized | mt. | - | - | - | - | 3,0 | 10 ad/pcs |
| 151-6525-1600 | PVC Ray Profili / PVC Rail Profile | Gri / Grey | mt. | - | - | - | - | 3,0 | 30 ad/pcs |

Multiline 7

50 KG SÜRME KAPAK SİSTEMİ • SLIDING DOOR SYSTEM

Yeni Ürün
New Product



Bilgi / Information

- 1 Kutu İçeriği : 2 Kapak Yavaşlatıcı Mekanizma
- In 1 box : 2 Door Mechanism with Soft Closers

Yavaşlatıcı Alternatifi / Soft Closer Alternative

- Sistem üzerinde entegre yavaşlatıcı mevcuttur.
- The system has integrated soft closer.



103-1070 1 Set İçeriği / 1 Set Includes

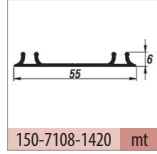
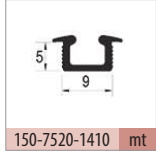
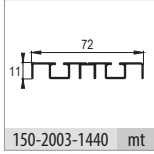
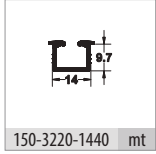

Ray Profilleri / Rail Profiles

Kulp Profilleri / Handle Profiles

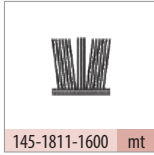
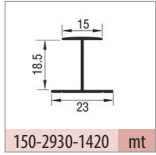
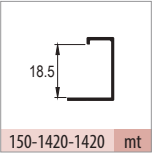
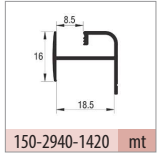
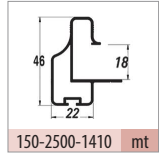
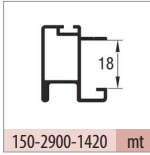

Teknik Detay / Technical Detail

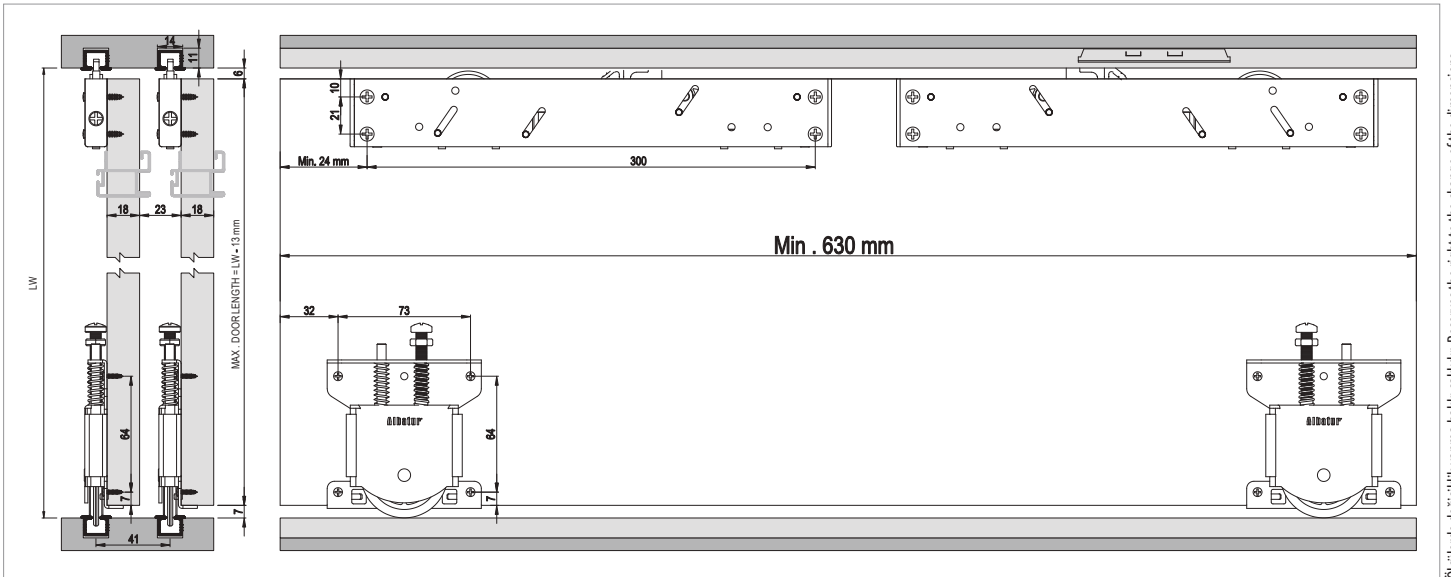

Ölçülerde değişiklik yapma hakkı saklıdır. Reserves the right to the change of the dimensions.

| Kod / Code No | Açıklama / Description | Renk / Colour | Birim / Unit | | | Profil mt. / Profiles mt. | Bağ / Bnd. |
|---------------|---|------------------------------|-----------------|-----|-------|---------------------------|------------|
| 103-1070-1200 | Multiline 7 Sürme Gardrop Sistemi / Sliding Wardrobe System | Silver | 2 Kapak / 1 Set | 12 | 360 | - - - | - |
| 145-1811-1600 | Kil Fital / Ec-Wf Hair Wick | Gri / Grey | mt. | 300 | 7.200 | - - - | - |
| 150-3220-1440 | Alüminyum Alt-Üst Ray Profili / Aluminium Bottom-Top Rail Profile | Bronz Parlak / Bronze Bright | mt. | - | - | - - 3,0 | 20 ad/pcs |
| 150-2003-1440 | Alüminyum Alt-Üst Ray Profili / Aluminium Bottom-Top Rail Profile | Bronz Parlak / Bronze Bright | mt. | - | - | - - 3,0 | 12 ad/pcs |
| 150-7108-1420 | Alüminyum Alt Ray Profili / Aluminium Bottom Rail Profile | Parlak / Bright | mt. | - | - | - - 3,0 | 12 ad/pcs |
| 150-7520-1410 | Alüminyum Alt Ray Profili / Aluminium Bottom Rail Profile | Eloksal / Mat Anodized | mt. | - | - | - - 3,0 | 30 ad/pcs |
| 150-2900-1420 | Alüminyum Kulp Profili / Aluminium Handle Profile | Parlak / Bright | mt. | - | - | 2,0 2,5 3,0 | 6 ad/pcs |
| 150-2500-1410 | Alüminyum Kulp Profili / Aluminium Handle Profile | Eloksal / Mat Anodized | mt. | - | - | - - 3,0 | 6 ad/pcs |
| 150-2940-1420 | Alüminyum Orta Kayıt / Aluminium Horizontal Central | Parlak / Bright | mt. | - | - | - - 3,0 | 10 ad/pcs |
| 150-1420-1420 | Alüminyum Kapama Profili / Aluminium Closure Profile | Parlak / Bright | mt. | - | - | - - 3,0 | 10 ad/pcs |
| 150-2930-1420 | Alüminyum Orta Kayıt / Aluminium Horizontal Central | Parlak / Bright | mt. | - | - | - - 3,0 | 10 ad/pcs |

Multiline 8

50 KG SÜRME KAPAK SİSTEMİ • SLIDING DOOR SYSTEM

Yeni Ürün
New Product



Bilgi / Information

- 1 Kutu İçeriği : 2 Kapak Mekanizma + 4 Ad Yavaşlatıcı
- In 1 box : 2 Door Mechanism + 4 Pcs Soft Closers



103-1080 1 Set İçeriği / 1 Set Includes

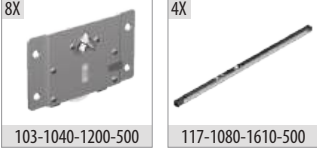

Ray Profilleri / Rail Profiles

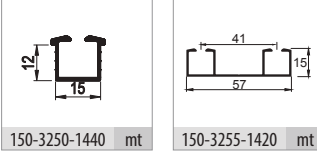

Kulp Profilleri / Handle Profiles

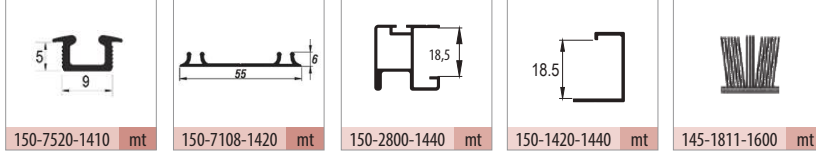

Teknik Detay / Technical Detail

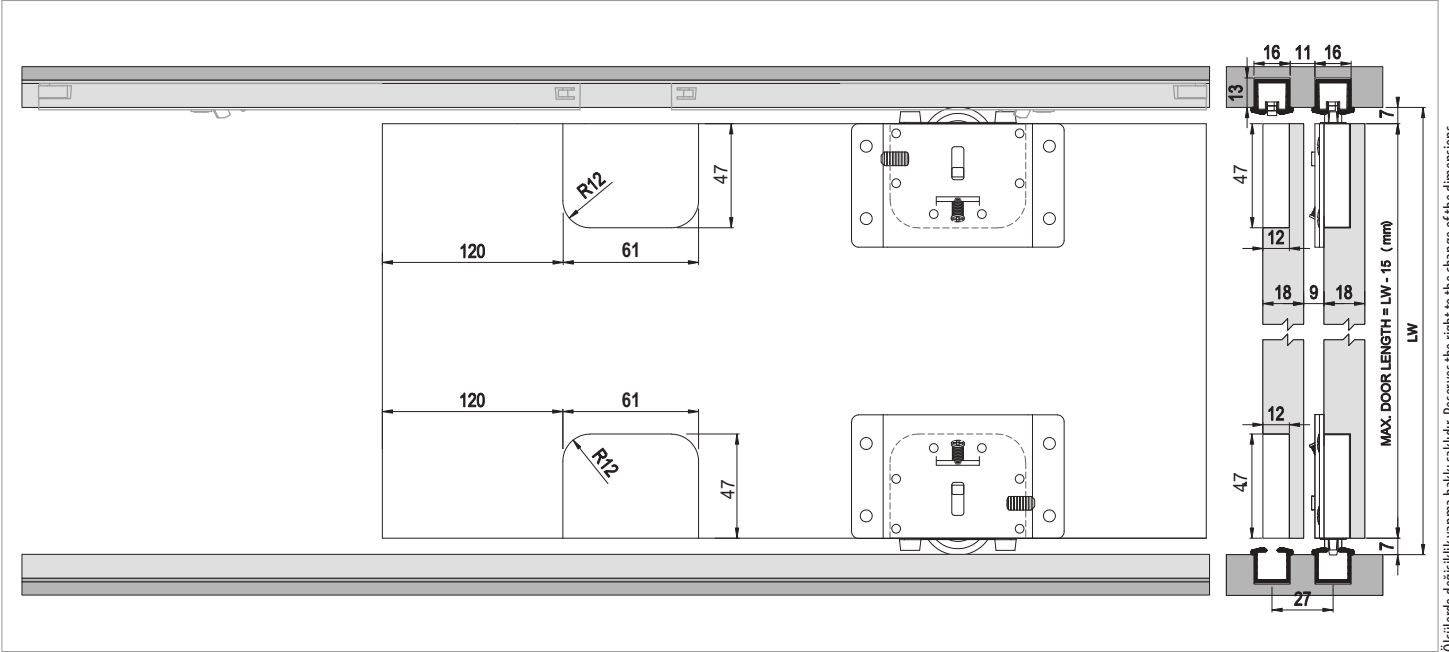

Ölçülerde değişiklik yapma hakkı saklıdır. Reserves the right to the change of the dimensions.

| Kod / Code No | Açıklama / Description | Renk / Colour | Birim / Unit | | | Profil mt. / Profiles mt. | Bağ / Bnd. |
|---------------|---|------------------------------|-----------------|-----|-------|---------------------------|------------|
| 103-1080-1200 | Multiline 8 - Sürme Gardirop Sistemi / Sliding Wardrobe System | Silver | 2 Kapak / 1 Set | 12 | 360 | - - - | - |
| 145-1811-1600 | Kıl Fital / Ec-Wf Hair Wick | Gri / Grey | mt. | 300 | 7.200 | - - - | - |
| 150-3250-1440 | Alüminyum Alt-Üst Ray Profili / Aluminium Bottom-Top Rail Profile | Bronz Parlak / Bronze Bright | mt. | - | - | - - 3,0 | 4 ad/pcs |
| 150-3255-1420 | Alüminyum Üst Ray Profili / Aluminium Top Rail Profile | Parlak / Bright | mt. | - | - | - - 3,0 | 12 ad/pcs |
| 150-7108-1420 | Alüminyum Alt Ray Profili / Aluminium Bottom Rail Profile | Parlak / Bright | mt. | - | - | - - 3,0 | 12 ad/pcs |
| 150-7520-1410 | Alüminyum Alt Ray Profili / Aluminium Bottom Rail Profile | Eloksal / Mat Anodized | mt. | - | - | - - 3,0 | 30 ad/pcs |
| 150-2800-1440 | Alüminyum Kulp Profili / Aluminium Handle Profile | Bronz Parlak / Bronze Bright | mt. | - | - | - - 3,0 | 6 ad/pcs |
| 150-1420-1440 | Alüminyum Kapama Profili / Aluminium Closure Profile | Bronz Parlak / Bronze Bright | mt. | - | - | - - 3,0 | 10 ad/pcs |

Multiline 9

45 KG SÜRME KAPAK SİSTEMİ • SLIDING DOOR SYSTEM

Yeni Ürün
New Product

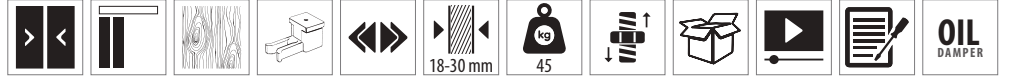

Yavaşlatıcı Alternatifi / Soft Closer Alternative

117-6959-1600 <<>>



103-1090 1 Takım İçeriği / 1 Kit Includes

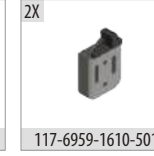
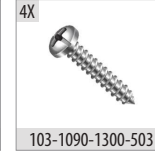
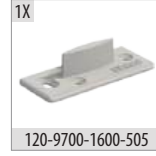
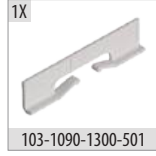

103-1091 1 Takım İçeriği / 1 Kit Includes

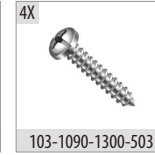
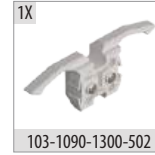
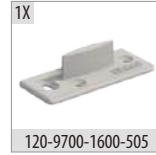
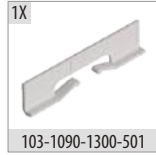

Ray Profilleri / Rail Profiles

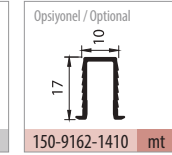
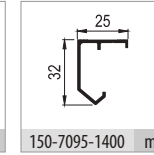
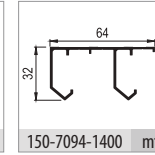

Teknik Detay / Technical Detail

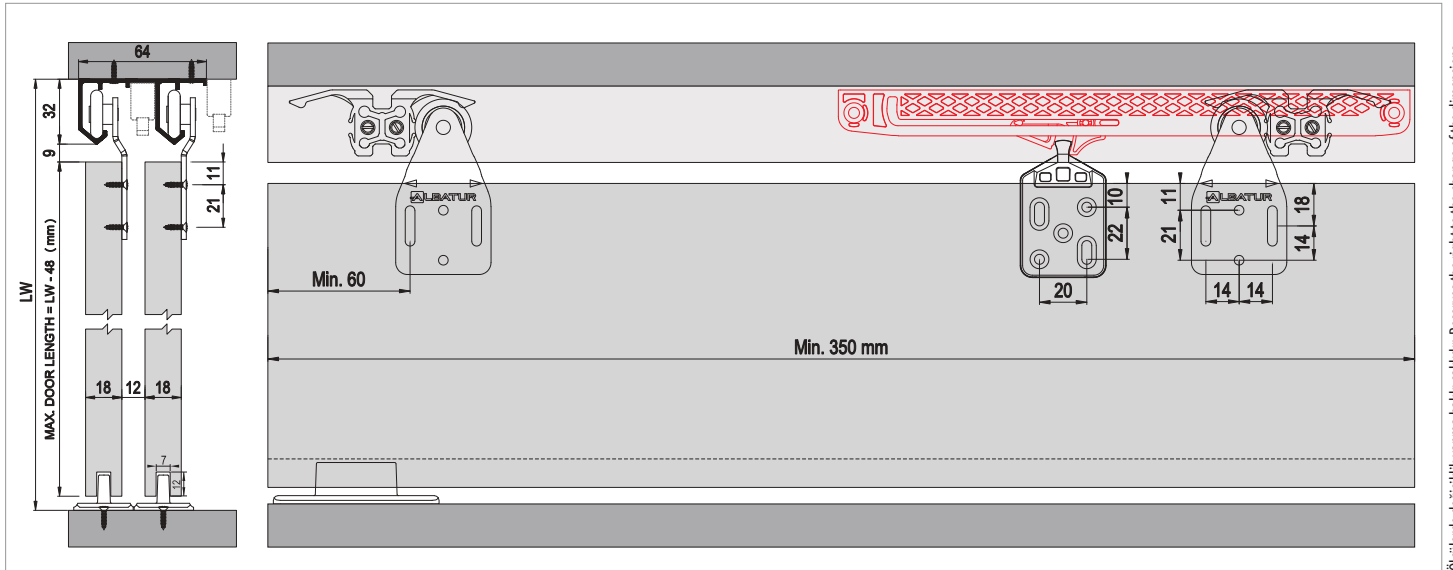

Ölçülerde değişiklik yapma hakkı saklıdır. Reserves the right to the change of the dimensions.

| Kod / Code No | Açıklama / Description | Renk / Colour | Birim / Unit | | | Profil mt. / Profiles mt. | Bağ / Bnd. |
|---------------|--|------------------------|-----------------|----|-------|---------------------------|------------|
| 103-1090-1300 | Multiline 9 - Sürme Kapak Sistemi / Sliding Door System | Galvaniz / Galvanized | 1 Kapak / 1 Kit | 24 | 768 | - | - |
| 103-1091-1300 | Multiline 9 - Sürme Kapak Sistemi / Sliding Door System | Galvaniz / Galvanized | 1 Kapak / 1 Kit | 24 | 768 | - | - |
| 117-6959-1610 | 50 Kg Yavaşlatıcı Mekanizma / 50 Kg Soft Closer Mechanism | Gri / Grey | 1 Takım / 1 Kit | 50 | 1.250 | - | - |
| 150-7094-1400 | Alüminyum Üst Ray Profili / Aluminium Top Rail Profile | Pres / Uncoated | mt. | - | - | - | 3,0 |
| 150-7095-1400 | Alüminyum Üst Ray Profili / Aluminium Top Rail Profile | Pres / Uncoated | mt. | - | - | - | 3,0 |
| 150-9162-1410 | Alüminyum Alt Klavuz Profili / Aluminium Bottom Slider Profile | Eloksal / Mat Anodized | mt. | - | - | - | 3,0 |

Multiline 10

50 KG SÜRME KAPAK SİSTEMİ • SLIDING DOOR SYSTEM

Yeni Ürün
New Product



Bilgi / Information

- 1 Kutu İçeriği : 2 Kapak Mekanizma + 4 Ad Yavaşlatıcı
- In 1 box : 2 Door Mechanism + 4 Pcs Soft Closers



103-1100 1 Set İçeriği / 1 Set Includes

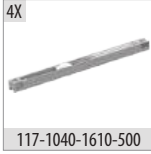
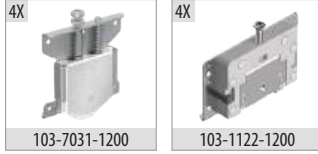

Ray Profilleri / Rail Profiles

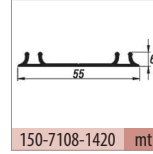
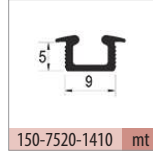
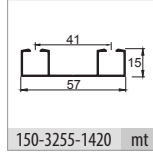
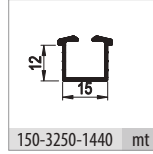

Kulp Profilleri / Handle Profiles

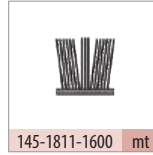
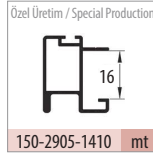
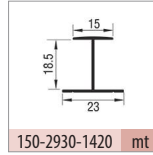
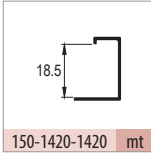
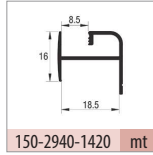
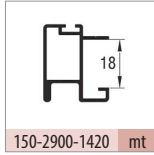

Teknik Detay / Technical Detail

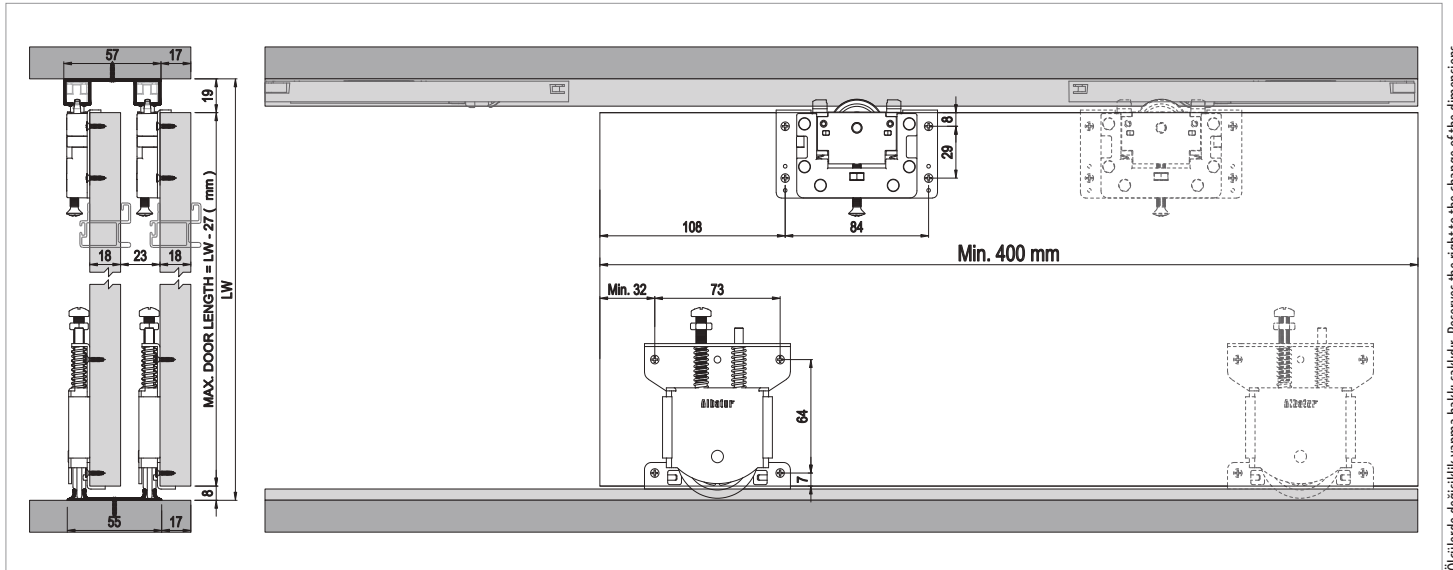

Ölçülerde değişiklik yapma hakkı saklıdır. Reserves the right to the change of the dimensions.

| Kod / Code No | Açıklama / Description | Renk / Colour | Birim / Unit | | | Profil mt. / Profiles mt. | Bağ / Bnd. |
|---------------|---|------------------------------|-----------------|-----|-------|---------------------------|------------|
| 103-1100-1200 | Multiline 10 - Sürme Gardirop Sistemi / Sliding Wardrobe System | Silver | 2 Kapak / 1 Set | 12 | 360 | - - - | - |
| 145-1811-1600 | Kıl Fital / Ec-Wf Hair Wick | Gri / Grey | mt. | 300 | 7.200 | - - - | - |
| 150-3250-1440 | Alüminyum Alt-Üst Ray Profili / Aluminium Bottom-Top Rail Profile | Bronz Parlak / Bronze Bright | mt. | - | - | - - 3,0 | 4 ad/pcs |
| 150-3255-1420 | Alüminyum Üst Ray Profili / Aluminium Top Rail Profile | Parlak / Bright | mt. | - | - | - - 3,0 | 12 ad/pcs |
| 150-7108-1420 | Alüminyum Alt Ray Profili / Aluminium Bottom Rail Profile | Parlak / Bright | mt. | - | - | - - 3,0 | 12 ad/pcs |
| 150-7520-1410 | Alüminyum Alt Ray Profili / Aluminium Bottom Rail Profile | Eloksal / Mat Anodized | mt. | - | - | - - 3,0 | 30 ad/pcs |
| 150-2900-1420 | Alüminyum Kulp Profili / Aluminium Handle Profile | Parlak / Bright | mt. | - | - | 2,0 2,5 3,0 | 6 ad/pcs |
| 150-2940-1420 | Alüminyum Orta Kayıt / Aluminium Horizontal Central | Parlak / Bright | mt. | - | - | - - 3,0 | 10 ad/pcs |
| 150-1420-1420 | Alüminyum Kapama Profili / Aluminium Closure Profile | Parlak / Bright | mt. | - | - | - - 3,0 | 10 ad/pcs |
| 150-2930-1420 | Alüminyum Orta Kayıt / Aluminium Horizontal Central | Parlak / Bright | mt. | - | - | - - 3,0 | 10 ad/pcs |
| 150-2905-1410 | Alüminyum Kulp Profili / Aluminium Handle Profile | Eloksal / Mat Anodized | mt. | - | - | - - 3,0 | 6 ad/pcs |

Multiline 11

50 KG SÜRME KAPAK SİSTEMİ • SLIDING DOOR SYSTEM

Yeni Ürün
New Product



Bilgi / Information

- 1 Kutu İçeriği : 2 Kapak Mekanizma + 4 Ad Yavaşlatıcı
- In 1 box : 2 Door Mechanism + 4 Pcs Soft Closers



103-1110 1 Set İçeriği / 1 Set Includes

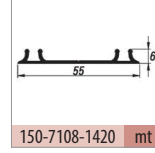
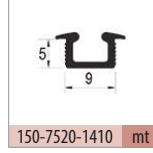
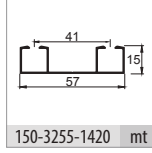
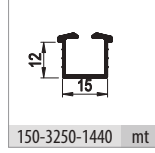
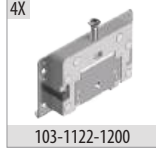

Ray Profilleri / Rail Profiles

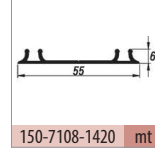
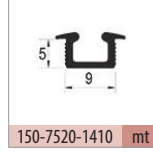
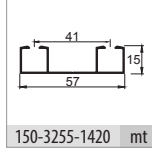
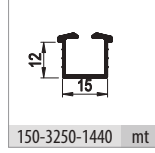
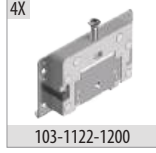

Kulp Profilleri / Handle Profiles

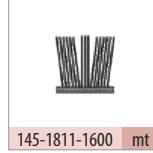
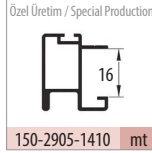
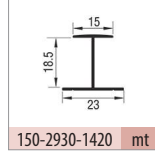
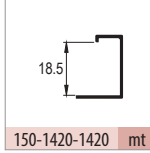
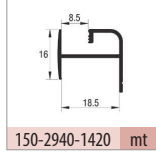
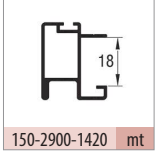

Teknik Detay / Technical Detail

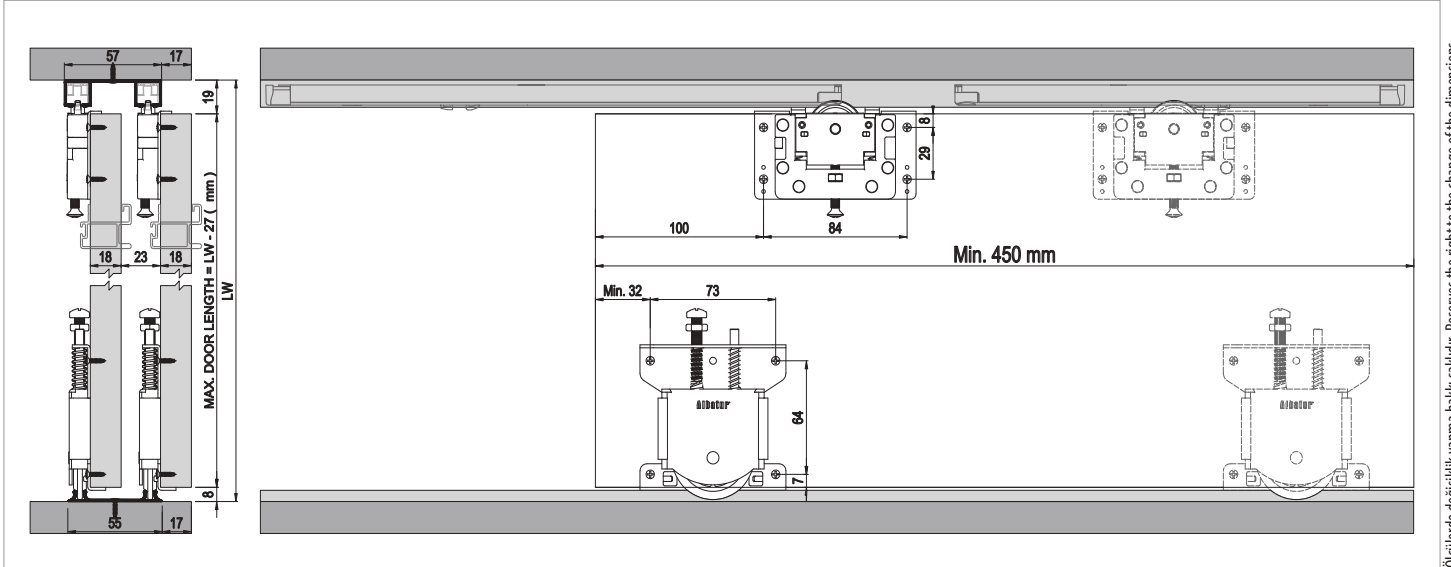

Ölçülerde değişiklik yapma hakkı saklıdır. Reserves the right to the change of the dimensions.

| Kod / Code No | Açıklama / Description | Renk / Colour | Birim / Unit | | | Profil mt. / Profiles mt. | Bağ / Bnd. |
|---------------|---|------------------------------|-----------------|-----|-------|---------------------------|------------|
| 103-1110-1200 | Multiline 11 - Sürme Gardirop Sistemi / Sliding Wardrobe System | Silver | 2 Kapak / 1 Set | 12 | 360 | - - - | - |
| 145-1811-1600 | Kıl Fital / Ec-Wf Hair Wick | Gri / Grey | mt. | 300 | 7.200 | - - - | - |
| 150-3250-1440 | Alüminyum Alt-Üst Ray Profili / Aluminium Bottom-Top Rail Profile | Bronz Parlak / Bronze Bright | mt. | - | - | - - 3,0 | 4 ad/pcs |
| 150-3255-1420 | Alüminyum Üst Ray Profili / Aluminium Top Rail Profile | Parlak / Bright | mt. | - | - | - - 3,0 | 12 ad/pcs |
| 150-7108-1420 | Alüminyum Alt Ray Profili / Aluminium Bottom Rail Profile | Parlak / Bright | mt. | - | - | - - 3,0 | 12 ad/pcs |
| 150-7520-1410 | Alüminyum Alt Ray Profili / Aluminium Bottom Rail Profile | Eloksal / Mat Anodized | mt. | - | - | - - 3,0 | 30 ad/pcs |
| 150-2900-1420 | Alüminyum Kulp Profili / Aluminium Handle Profile | Parlak / Bright | mt. | - | - | 2,0 2,5 3,0 | 6 ad/pcs |
| 150-2940-1420 | Alüminyum Orta Kayıt / Aluminium Horizontal Central | Parlak / Bright | mt. | - | - | - - 3,0 | 10 ad/pcs |
| 150-1420-1420 | Alüminyum Kapama Profili / Aluminium Closure Profile | Parlak / Bright | mt. | - | - | - - 3,0 | 10 ad/pcs |
| 150-2930-1420 | Alüminyum Orta Kayıt / Aluminium Horizontal Central | Parlak / Bright | mt. | - | - | - - 3,0 | 10 ad/pcs |
| 150-2905-1410 | Alüminyum Kulp Profili / Aluminium Handle Profile | Eloksal / Mat Anodized | mt. | - | - | - - 3,0 | 6 ad/pcs |

Multiline 12

50 KG SÜRME KAPAK SİSTEMİ • SLIDING DOOR SYSTEM

Yeni Ürün
New Product



Bilgi / Information

- 1 Kutu İçeriği : 2 Kapak Mekanizma + 4 Ad Yavaşlatıcı
- In 1 box : 2 Door Mechanism + 4 Pcs Soft Closers



103-1120 1 Set İçeriği / 1 Set Includes

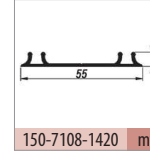
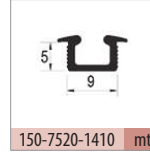
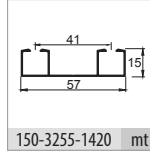
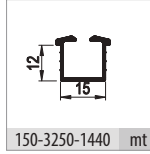
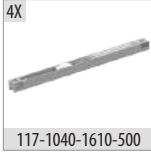
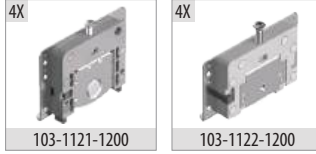

Ray Profilleri / Rail Profiles

Kulp Profilleri / Handle Profiles

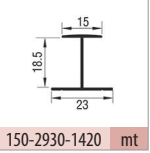
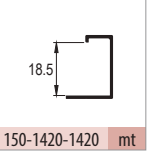
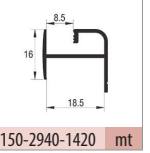
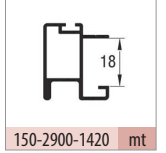

Teknik Detay / Technical Detail

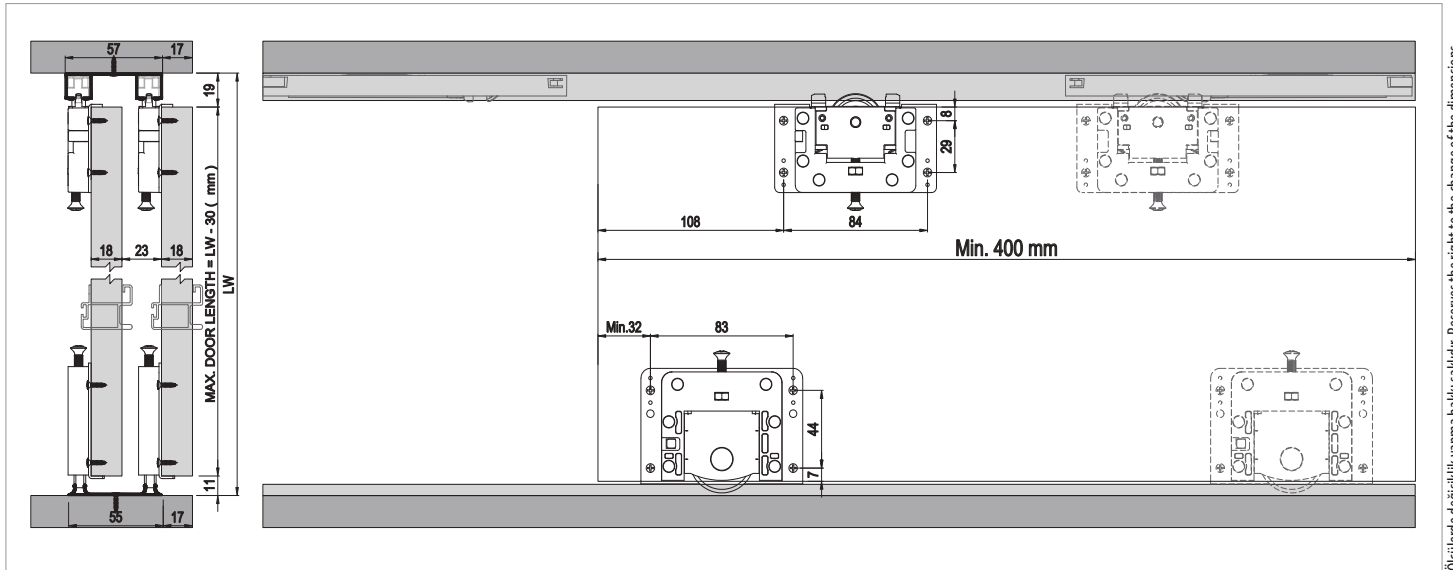

| Kod / Code No | Açıklama / Description | Renk / Colour | Birim / Unit | | | Profil mt. / Profiles mt. | Bağ / Bnd. |
|---------------|---|------------------------------|-----------------|-----|-------|---------------------------|------------|
| 103-1120-1200 | Multiline 12 - Sürme Gardrop Sistemi / Sliding Wardrobe System | Silver | 2 Kapak / 1 Set | 12 | 360 | - - - | - |
| 145-1811-1600 | Kıl Fital / Ec-Wf Hair Wick | Gri / Grey | mt. | 300 | 7.200 | - - - | - |
| 150-3250-1440 | Alüminyum Alt-Üst Ray Profili / Aluminium Bottom-Top Rail Profile | Bronz Parlak / Bronze Bright | mt. | - | - | - - 3,0 | 4 ad/pcs |
| 150-3255-1420 | Alüminyum Üst Ray Profili / Aluminium Top Rail Profile | Parlak / Bright | mt. | - | - | - - 3,0 | 12 ad/pcs |
| 150-7108-1420 | Alüminyum Alt Ray Profili / Aluminium Bottom Rail Profile | Parlak / Bright | mt. | - | - | - - 3,0 | 12 ad/pcs |
| 150-7520-1410 | Alüminyum Alt Ray Profili / Aluminium Bottom Rail Profile | Eloksal / Mat Anodized | mt. | - | - | - - 3,0 | 30 ad/pcs |
| 150-2900-1420 | Alüminyum Kulp Profili / Aluminium Handle Profile | Parlak / Bright | mt. | - | - | 2,0 2,5 3,0 | 6 ad/pcs |
| 150-2940-1420 | Alüminyum Orta Kayıt / Aluminium Horizontal Central | Parlak / Bright | mt. | - | - | - - 3,0 | 10 ad/pcs |
| 150-1420-1420 | Alüminyum Kapama Profili / Aluminium Closure Profile | Parlak / Bright | mt. | - | - | - - 3,0 | 10 ad/pcs |
| 150-2930-1420 | Alüminyum Orta Kayıt / Aluminium Horizontal Central | Parlak / Bright | mt. | - | - | - - 3,0 | 10 ad/pcs |

Multiline 13

50 KG SÜRME KAPAK SİSTEMİ • SLIDING DOOR SYSTEM

Yeni Ürün
New Product



Bilgi / Information

- 1 Kutu İçeriği : 2 Kapak Mekanizma + 4 Ad Yavaşlatıcı
- In 1 box : 2 Door Mechanism + 4 Pcs Soft Closers



103-1130 1 Set İçeriği / 1 Set Includes

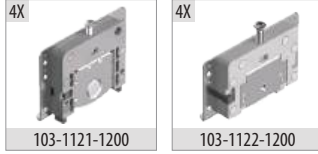

Ray Profilleri / Rail Profiles

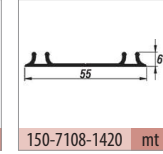
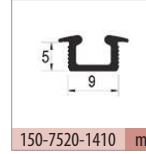
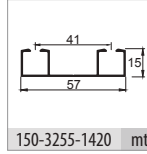
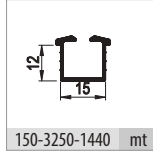

Kulp Profilleri / Handle Profiles

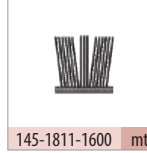
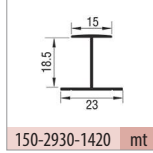
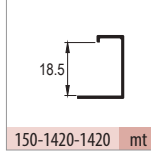
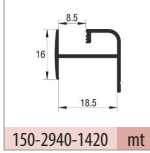
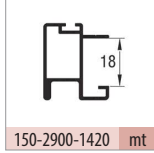

Teknik Detay / Technical Detail

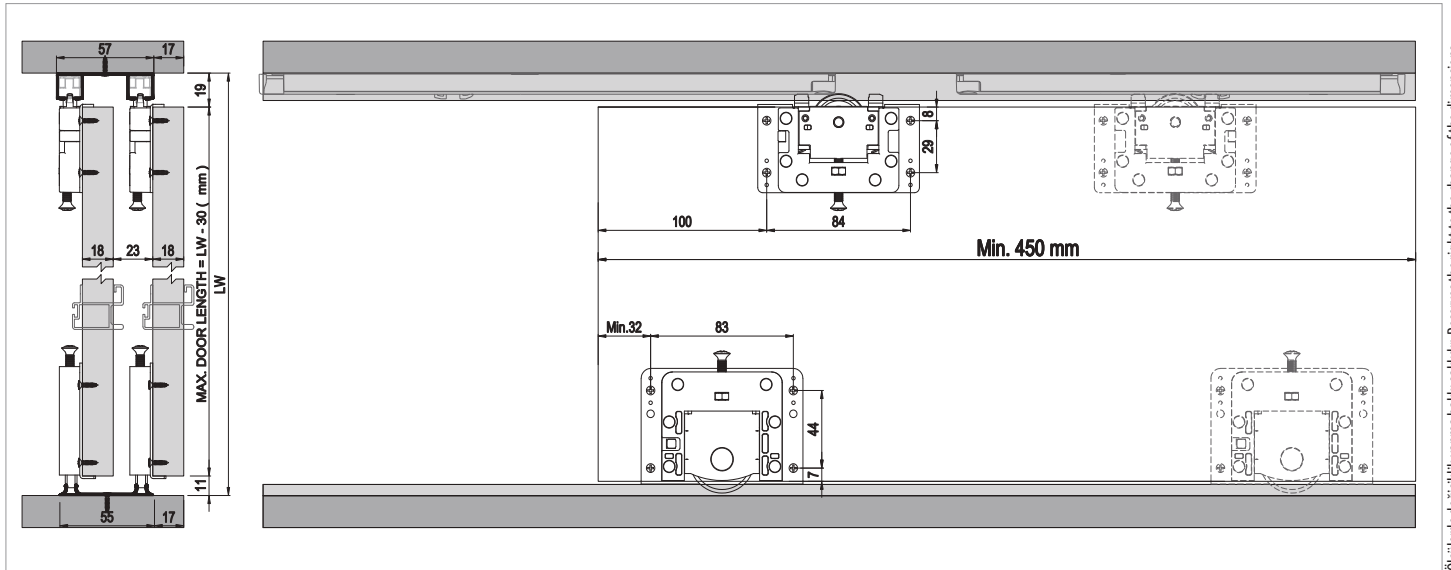

Ölçülerde değişiklik yapma hakkı saklıdır. Reserves the right to the change of the dimensions.

| Kod / Code No | Açıklama / Description | Renk / Colour | Birim / Unit | | | Profil mt. / Profiles mt. | Bağ / Bnd. |
|---------------|---|------------------------------|-----------------|-----|-------|---------------------------|------------|
| 103-1130-1200 | Multiline 13 - Sürme Gardrop Sistemi / Sliding Wardrobe System | Silver | 2 Kapak / 1 Set | 12 | 360 | - - - | - |
| 145-1811-1600 | Kıl Fital / Ec-Wf Hair Wick | Gri / Grey | mt. | 300 | 7.200 | - - - | - |
| 150-3250-1440 | Alüminyum Alt-Üst Ray Profili / Aluminium Bottom-Top Rail Profile | Bronz Parlak / Bronze Bright | mt. | - | - | - - 3,0 | 4 ad/pcs |
| 150-3255-1420 | Alüminyum Üst Ray Profili / Aluminium Top Rail Profile | Parlak / Bright | mt. | - | - | - - 3,0 | 12 ad/pcs |
| 150-7108-1420 | Alüminyum Alt Ray Profili / Aluminium Bottom Rail Profile | Parlak / Bright | mt. | - | - | - - 3,0 | 12 ad/pcs |
| 150-7520-1410 | Alüminyum Alt Ray Profili / Aluminium Bottom Rail Profile | Eloksal / Mat Anodized | mt. | - | - | - - 3,0 | 30 ad/pcs |
| 150-2900-1420 | Alüminyum Kulp Profili / Aluminium Handle Profile | Parlak / Bright | mt. | - | - | 2,0 2,5 3,0 | 6 ad/pcs |
| 150-2940-1420 | Alüminyum Orta Kayıt / Aluminium Horizontal Central | Parlak / Bright | mt. | - | - | - - 3,0 | 10 ad/pcs |
| 150-1420-1420 | Alüminyum Kapama Profili / Aluminium Closure Profile | Parlak / Bright | mt. | - | - | - - 3,0 | 10 ad/pcs |
| 150-2930-1420 | Alüminyum Orta Kayıt / Aluminium Horizontal Central | Parlak / Bright | mt. | - | - | - - 3,0 | 10 ad/pcs |

Multiline 14

15 KG SÜRME KAPAK SİSTEMİ • SLIDING DOOR SYSTEM

Yeni Ürün
New Product



Bilgi / Information

- 1 Kutu İçeriği : 1 Kapak Mekanizma + 2 Ad Yavaşlatıcı
- In 1 box : 1 Door Mechanism + 2 Pcs Soft Closers



103-1140 1 Takım İçeriği / 1 Kit Includes

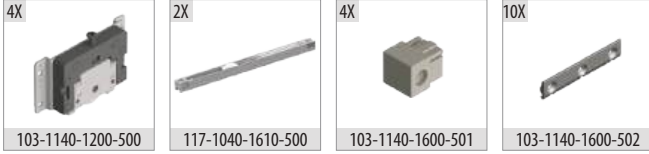

Ray Profilleri / Rail Profiles

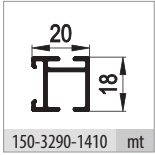

Teknik Detay / Technical Detail

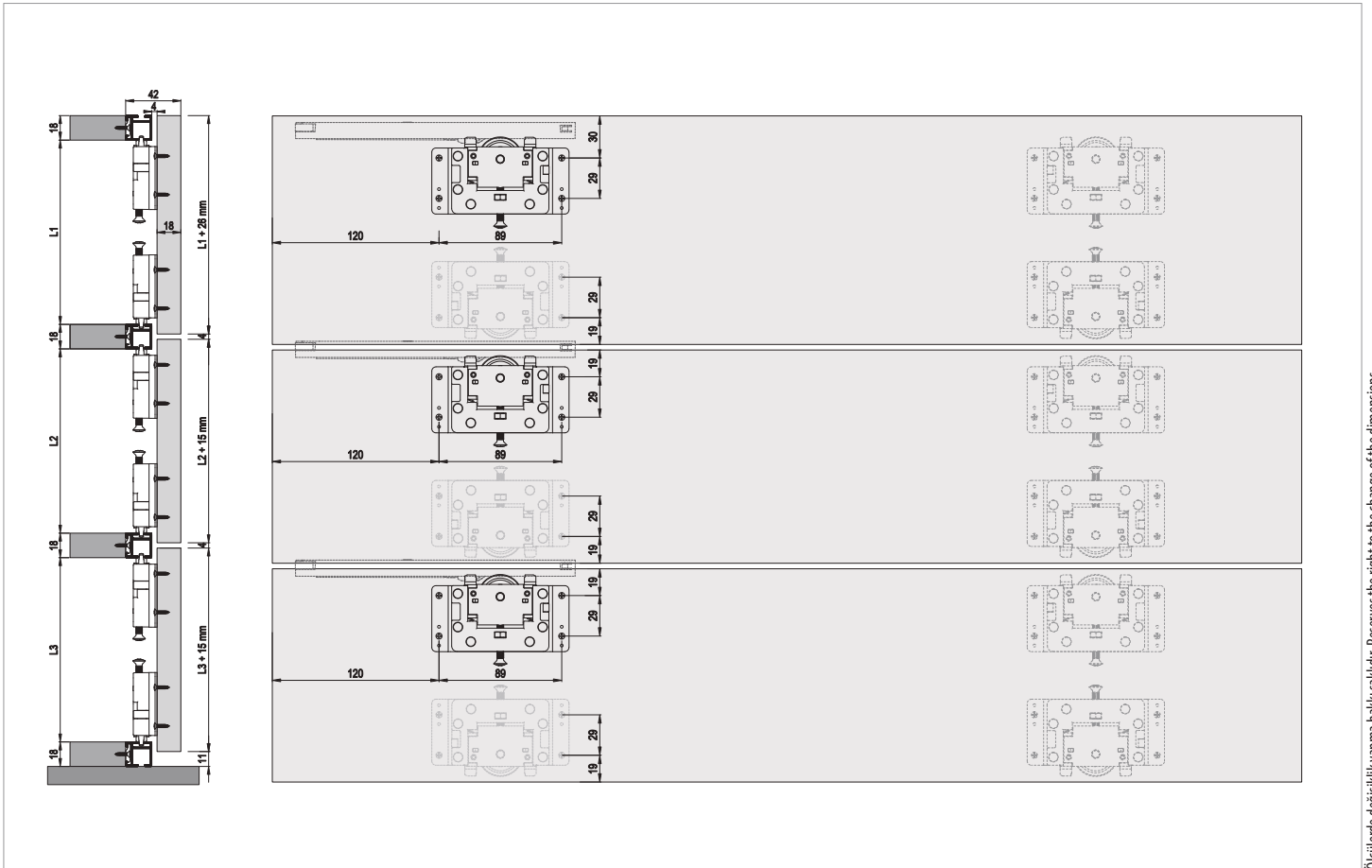

Ölçülerde değişiklik yapma hakkı saklıdır. Reserves the right to the change of the dimensions.

| Kod / Code No | Açıklama / Description | Renk / Colour | Birim / Unit | | | Profil mt. / Profiles mt. | Bağ / Bnd. |
|---------------|---|------------------------|-----------------|----|-----|---------------------------|------------|
| 103-1140-1200 | Multiline 14 - Sürme Gardırop Sistemi / Sliding Wardrobe System | Silver | 1 Kapak / 1 Kit | 12 | 360 | - - - | - |
| 150-3290-1410 | Alüminyum Alt-Üst Ray Profili / Aluminium Bottom-Top Rail Profile | Eloksal / Mat Anodized | mt. | - | - | - - 3,0 | 6 ad/pcs |



Bilgi / Information

- 1 Kutu İçeriği : 2 Kapak Mekanizma + 4 Ad Yavaşlatıcı
- In 1 box : 2 Door Mechanism + 4 Pcs Soft Closers

- 3 Kapaklı Dolap Uygulaması
- 3 Door Wardrobe Application



103-1150 1 Set İçeriği / 1 Set Includes

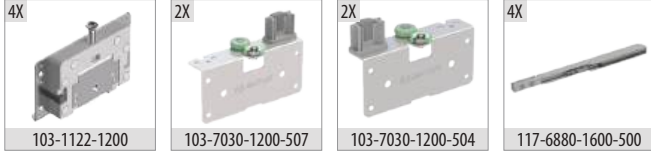

103-1151 Opsiyonel 3. İç Kapak / Optional 3. Internal Door

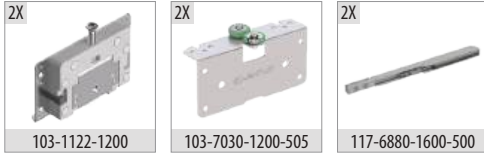

Ray Profilleri / Rail Profiles

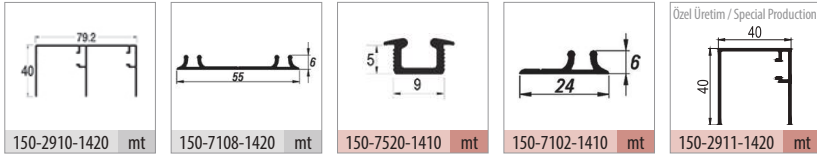

Kulp Profilleri / Handle Profiles

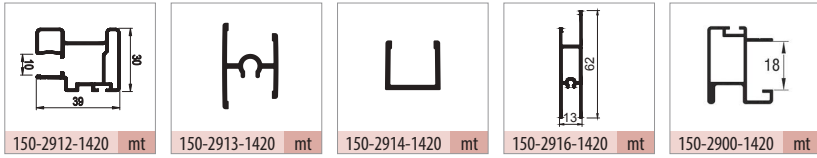

Opsiyonel Aksesuar / Optional Accessories

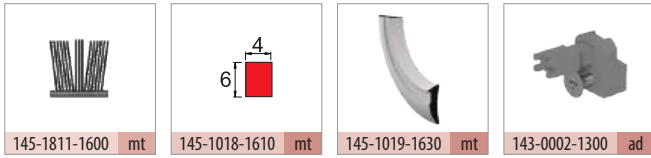

Teknik Detay / Technical Detail

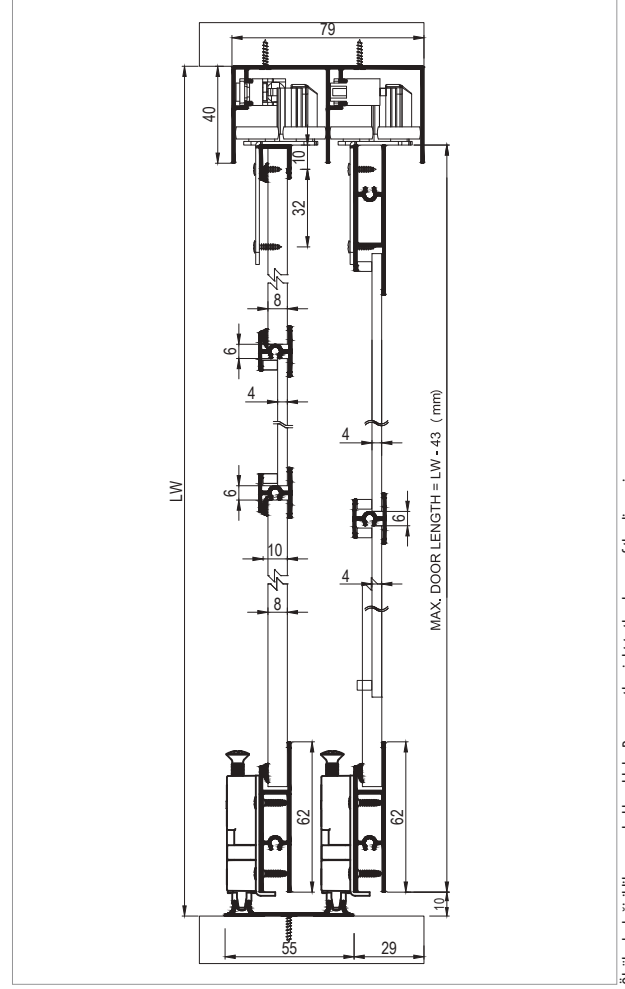

Ölçülerde değişiklik yapma hakkı saklıdır. Reserves the right to the change of the dimensions.

| Kod / Code No | Açıklama / Description | Renk / Colour | Birim / Unit | | | Profil mt. / Profiles mt. | Bağ / Bnd. |
|---------------|---|---------------------|-----------------|-----|-------|---------------------------|------------|
| 103-1150-1200 | Multiline 15 - Sürme Kapak Sistemi / Sliding Door System | Silver | 2 Kapak / 1 Set | 12 | 360 | - - - | - |
| 103-1151-1200 | Multiline 15 - Sürme Kapak Sistemi 3. Kapak / Sliding Door System 3. Door | Silver | 1 Kapak / 1 Kit | 8 | 400 | - - - | - |
| 143-0002-1300 | Bağlantı Kiti / Connection Kit | Silver | 1 Adet / 1 Pcs | - | - | - - - | - |
| 145-1018-1610 | Cam Adaptör Fitolü / Glass Adapter Wick | Şeffaf / Transparan | mt. | 100 | 3.600 | - - - | - |
| 145-1019-1630 | 8 mm Panel Adaptör Fitolü / 8 mm Panel Adapter Wick | Siyah / Black | mt. | 100 | 3.600 | - - - | - |
| 145-1811-1600 | Kıl Fitolü / Ec-Wf Hair Wick | Gri / Grey | mt. | 300 | 7.200 | - - - | - |
| 150-2910-1420 | Alüminyum Üst Ray Profili / Aluminium Top Rail Profile | Parlak / Bright | mt. | - | - | 2,0 2,5 3,0 | 6 ad/pcs |
| 150-7108-1420 | Alüminyum Alt Ray Profili / Aluminium Bottom Rail Profile | Parlak / Bright | mt. | - | - | 2,0 2,5 3,0 | 12 ad/pcs |
| 150-2912-1420 | Alüminyum Kulp Profili / Aluminium Handle Profile | Parlak / Bright | mt. | - | - | 2,0 - 3,0 | 4 ad/pcs |
| 150-2913-1420 | Alüminyum Orta Kayıt / Aluminium Horizontal Central | Parlak / Bright | mt. | - | - | - 3,0 | 10 ad/pcs |
| 150-2914-1420 | Alüminyum Kapama Profili / Aluminium Closure Profile | Parlak / Bright | mt. | - | - | - 3,0 | 24 ad/pcs |
| 150-2916-1420 | Alüminyum Çerçeve Profili / Aluminium Frame Profile | Parlak / Bright | mt. | - | - | - 3,0 | 4 ad/pcs |



alaturas.com

Multiline SRG 100

60 KG SÜRME KAPAK SİSTEMİ • SLIDING DOOR SYSTEM



Bilgi / Information

- 1 Kutu İçeriği : 2 Kapak Mekanizma + 4 Ad Yavaşlatıcı
- In 1 box : 2 Door Mechanism + 4 Pcs Soft Closers

- 3 Kapaklı Dolap Uygulaması
- 3 Door Wardrobe Application



103-0100 1 Set İçeriği / 1 Set Includes

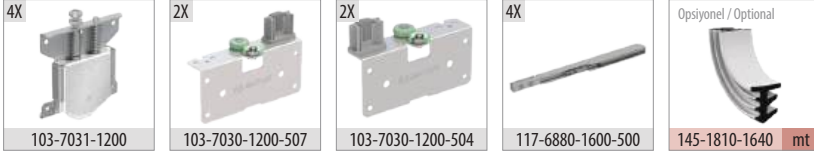

103-0103 Opsiyonel 3. İç Kapak / Optional 3. Internal Door

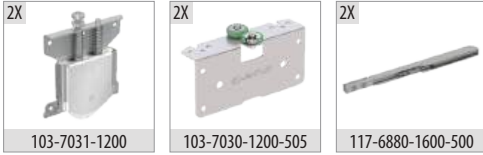

Ray Profilleri / Rail Profiles

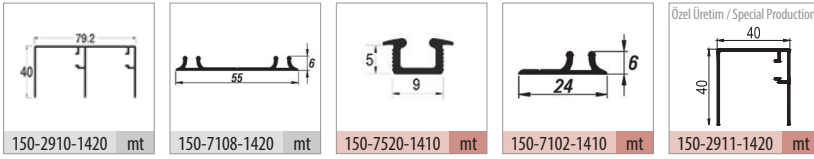

Kulp Profilleri / Handle Profiles

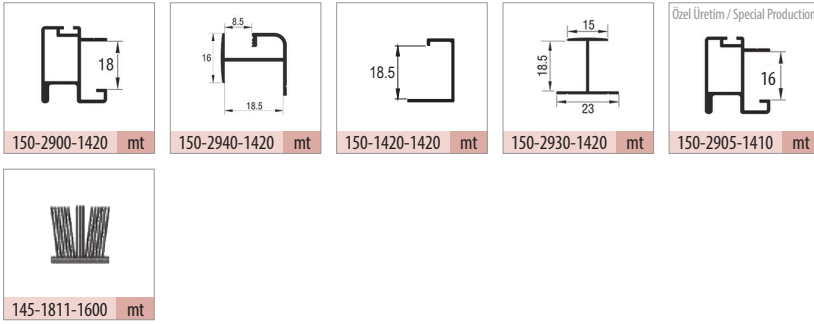

Teknik Detay / Technical Detail

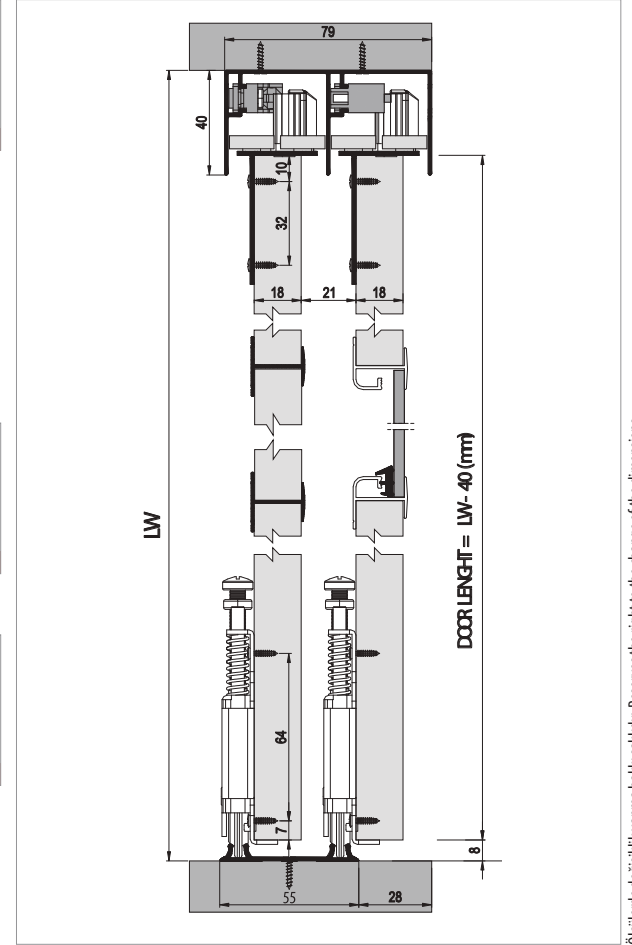

Ölçülerde değişiklik yapma hakkı saklıdır. Reserves the right to the change of the dimensions.

| Kod / Code No | Açıklama / Description | Renk / Colour | Birim / Unit | | | Profil mt. / Profiles mt. | Bağ / Bnd. |
|---------------|--|---------------------|-----------------|-----|-------|---------------------------|------------|
| 103-0100-1200 | SRG 100 - Sürme Kapak Sistemi / Sliding Door System | Silver | 2 Kapak / 1 Set | 12 | 360 | - - - | - |
| 103-0103-1200 | SRG 100 C - Sürme Kapak Sistemi 3. Kapak / Sliding Wardrobe System 3. Door | Silver | 1 Kapak / 1 Kit | 8 | 400 | - - - | - |
| 145-1810-1640 | Cam Fitolu / Glass Wick | Şeffaf / Transparan | mt. | 100 | 3.600 | - - - | - |
| 150-2910-1420 | Alüminyum Üst Ray Profili / Aluminium Top Rail Profile | Parlak / Bright | mt. | - | - | 2,0 2,5 3,0 | 6 ad/pcs |
| 150-7108-1420 | Alüminyum Alt Ray Profili / Aluminium Bottom Rail Profile | Parlak / Bright | mt. | - | - | 2,0 2,5 3,0 | 12 ad/pcs |
| 150-2900-1420 | Alüminyum Kulp Profili / Aluminium Handle Profile | Parlak / Bright | mt. | - | - | 2,0 2,5 3,0 | 6 ad/pcs |
| 150-2940-1420 | Alüminyum Orta Kayıt / Aluminium Horizontal Central | Parlak / Bright | mt. | - | - | - - 3,0 | 10 ad/pcs |
| 150-1420-1420 | Alüminyum Kapama Profili / Aluminium Closure Profile | Parlak / Bright | mt. | - | - | - - 3,0 | 10 ad/pcs |
| 150-2930-1420 | Alüminyum Orta Kayıt / Aluminium Horizontal Central | Parlak / Bright | mt. | - | - | - - 3,0 | 10 ad/pcs |

Multiline SRG 300

70 KG SÜRME KAPAK SİSTEMİ • SLIDING DOOR SYSTEM

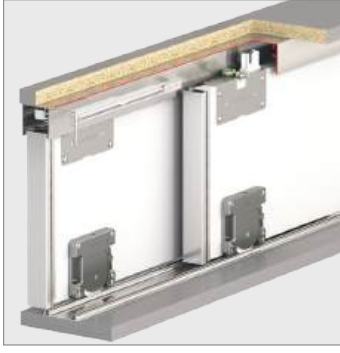

Bilgi / Information

- 1 Kutu İçeriği : 2 Kapak Mekanizma + 4 Ad Yavaşlatıcı
- In 1 box : 2 Door Mechanism + 4 Pcs Soft Closers



103-0300 1 Set İçeriği / 1 Set Includes

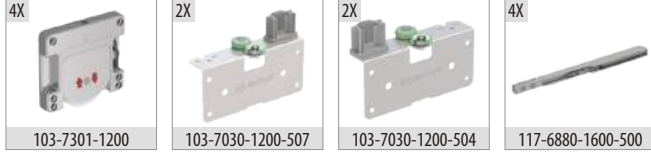

103-0303 Opsiyonel 3. İç Kapak / Optional 3. Internal Door

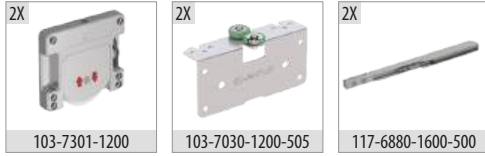

Ray Profilleri / Rail Profiles

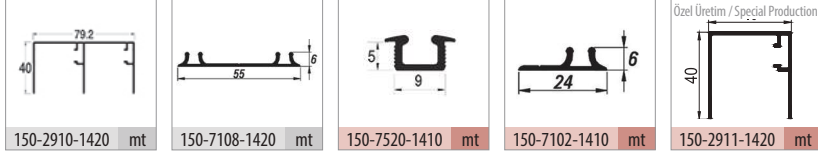

Kulp Profilleri / Handle Profiles

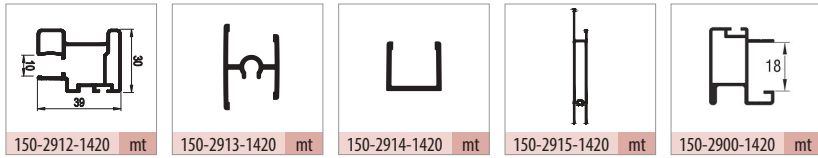

Opsiyonel Aksesuar / Optional Accessories

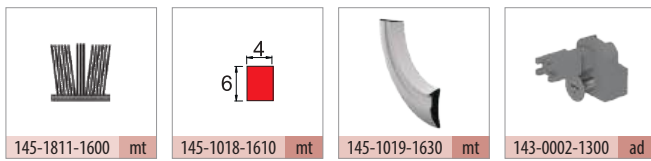

Teknik Detay / Technical Detail

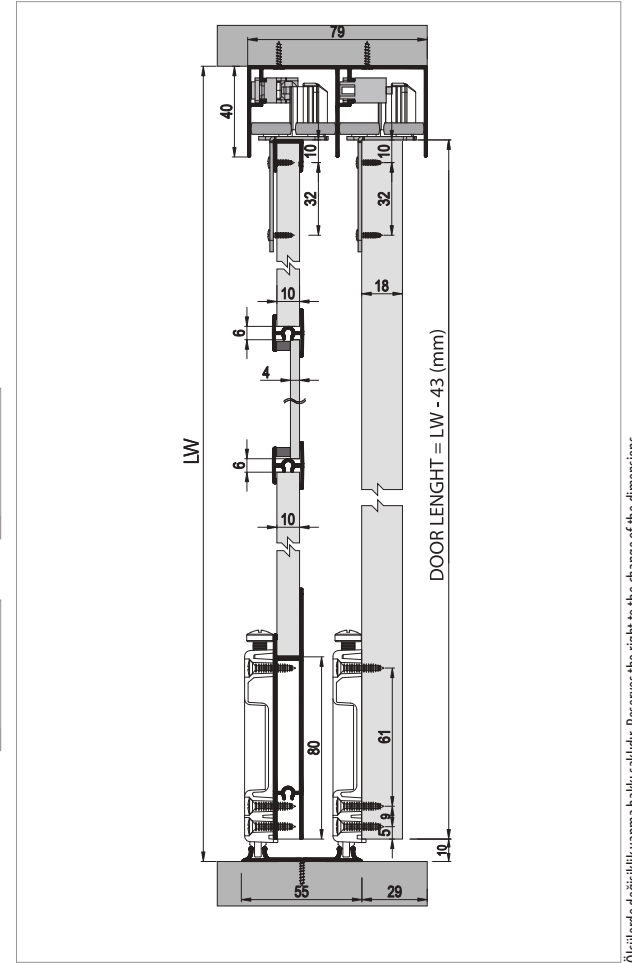

Ölçülerde değişiklik yapma hakkı saklıdır. Reserves the right to the change of the dimensions.

| Kod / Code No | Açıklama / Description | Renk / Colour | Birim / Unit | | | Profil mt. / Profiles mt. | Bağ / Bnd. |
|---------------|--|---------------------|-----------------|-----|-------|---------------------------|------------|
| 103-0300-1200 | SRG 300 - Sürme Kapak Sistemi / Sliding Door System | Silver | 2 Kapak / 1 Set | 12 | 360 | - - - | - |
| 103-0303-1200 | SRG 300 C - Sürme Kapak Sistemi 3. Kapak / Sliding Door System 3. Door | Silver | 1 Kapak / 1 Kit | 8 | 400 | - - - | - |
| 143-0002-1300 | Bağlantı Kiti / Connection Kit | Silver | 1 Adet / 1 Pcs | - | - | - - - | - |
| 145-1018-1610 | Cam Adaptör Fitolü / Glass Adapter Wick | Şeffaf / Transparan | mt. | 100 | 3.600 | - - - | - |
| 145-1019-1630 | 8 mm Panel Adaptör Fitolü / 8 mm Panel Adapter Wick | Siyah / Black | mt. | 100 | 3.600 | - - - | - |
| 145-1811-1600 | Kıl Fitolü / Ec-Wf Hair Wick | Gri / Grey | mt. | 300 | 7.200 | - - - | - |
| 150-2910-1420 | Alüminyum Üst Ray Profili / Aluminium Top Rail Profile | Parlak / Bright | mt. | - | - | 2,0 2,5 3,0 | 6 ad/pcs |
| 150-7108-1420 | Alüminyum Alt Ray Profili / Aluminium Bottom Rail Profile | Parlak / Bright | mt. | - | - | 2,0 2,5 3,0 | 12 ad/pcs |
| 150-2912-1420 | Alüminyum Kulp Profili / Aluminium Handle Profile | Parlak / Bright | mt. | - | - | - - 3,0 | 4 ad/pcs |
| 150-2913-1420 | Alüminyum Orta Kayıt / Aluminium Horizontal Central | Parlak / Bright | mt. | - | - | - - 3,0 | 10 ad/pcs |
| 150-2914-1420 | Alüminyum Kapama Profili / Aluminium Closure Profile | Parlak / Bright | mt. | - | - | - - 3,0 | 24 ad/pcs |
| 150-2915-1420 | Alüminyum Çerçeve Profili / Aluminium Frame Profile | Parlak / Bright | mt. | - | - | - - 3,0 | 4 ad/pcs |

Multiline SRG 110

70 KG SÜRME KAPAK SİSTEMİ • SLIDING DOOR SYSTEM



Bilgi / Information

- 1 Kutu İçeriği : 2 Kapak Mekanizma + 4 Ad Yavaşlatıcı
- In 1 box : 2 Door Mechanism + 4 Pcs Soft Closers

- 3 Kapaklı Dolap Uygulaması
- 3 Door Wardrobe Application



103-0110 1 Set İçeriği / 1 Set Includes

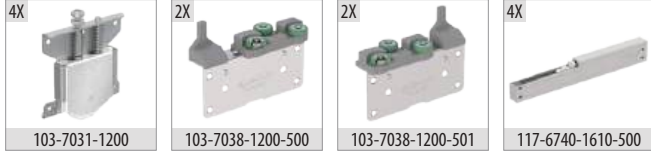

Ray Profilleri / Rail Profiles

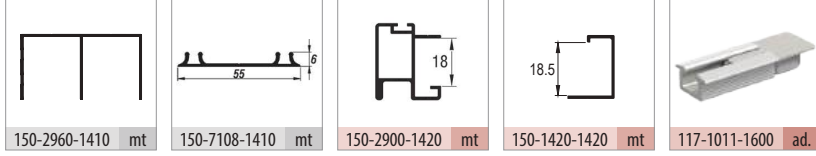

Kulp Profilleri / Handle Profiles



Teknik Detay / Technical Detail

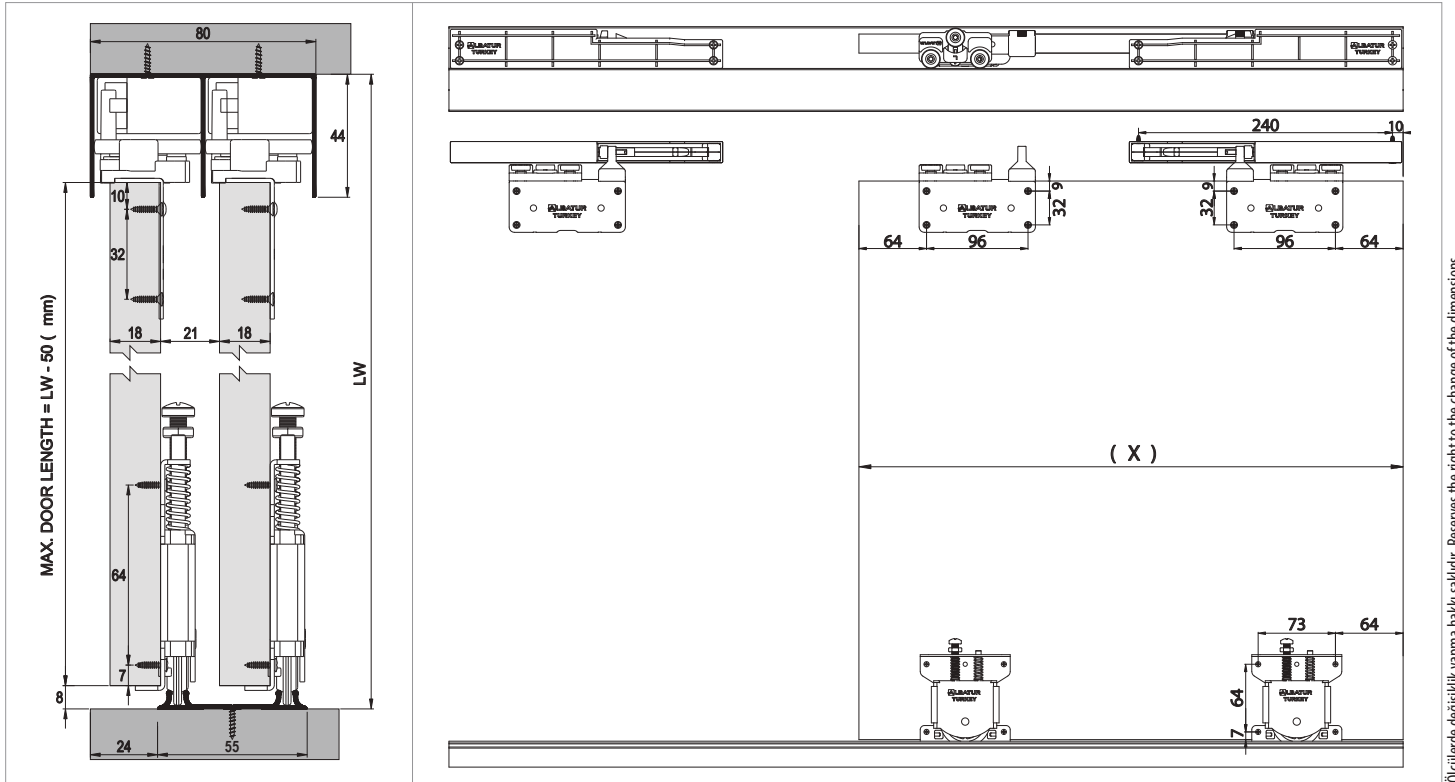

Ölçülerde değişiklik yapma hakkı saklıdır. Reserves the right to the change of the dimensions.

| Kod / Code No | Açıklama / Description | Renk / Colour | Birim / Unit | | | Profil mt. / Profiles mt. | Bağ / Bnd. |
|---------------|---|------------------------|-----------------|-------|---------|---------------------------|------------|
| 103-0110-1200 | SRG 110 - Sürme Kapak Sistemi / Sliding Door System | Silver | 2 Kapak / 1 Set | 12 | 216 | - - - | - |
| 117-1011-1600 | Plastik Ray Tapası / Plastic Rail Cap | Gri / Grey | 1 Adet / 1 Pcs | 1.000 | 120.000 | - - - | - |
| 150-2960-1410 | Alüminyum Üst Ray Profili / Aluminium Top Rail Profile | Eloksal / Mat Anodized | mt. | - | - | 2,0 2,5 3,0 | 6 ad/pcs |
| 150-7108-1410 | Alüminyum Alt Ray Profili / Aluminium Bottom Rail Profile | Eloksal / Mat Anodized | mt. | - | - | 2,0 2,5 3,0 | 12 ad/pcs |
| 150-2900-1420 | Alüminyum Kulp Profili / Aluminium Handle Profile | Parlak / Bright | mt. | - | - | 2,0 2,5 3,0 | 6 ad/pcs |
| 150-1420-1420 | Alüminyum Kapama Profili / Aluminium Closure Profile | Parlak / Bright | mt. | - | - | - - 3,0 | 10 ad/pcs |

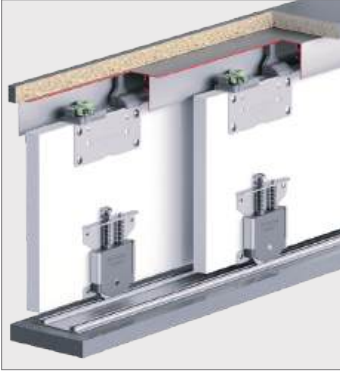

Bilgi / Information

- 1 Kutu İçeriği : 2 Kapak Mekanizma + 4 Ad Yavaşlatıcı
- In 1 box : 2 Door Mechanism + 4 Pcs Soft Closers

- 3 Kapaklı Dolap Uygulaması
- 3 Door Wardrobe Application

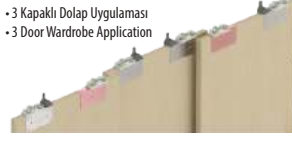

103-0115 1 Set İçeriği / 1 Set Includes

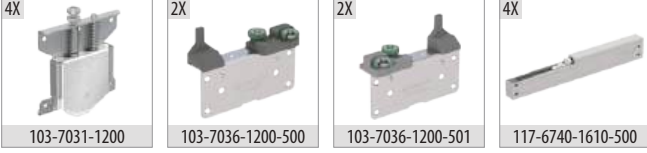

Ray Profilleri / Rail Profiles

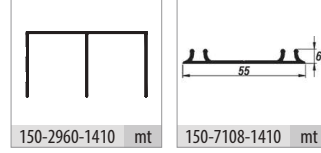

Kulp Profilleri / Handle Profiles

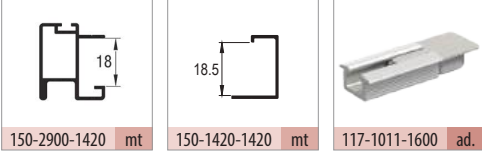

Teknik Detay / Technical Detail

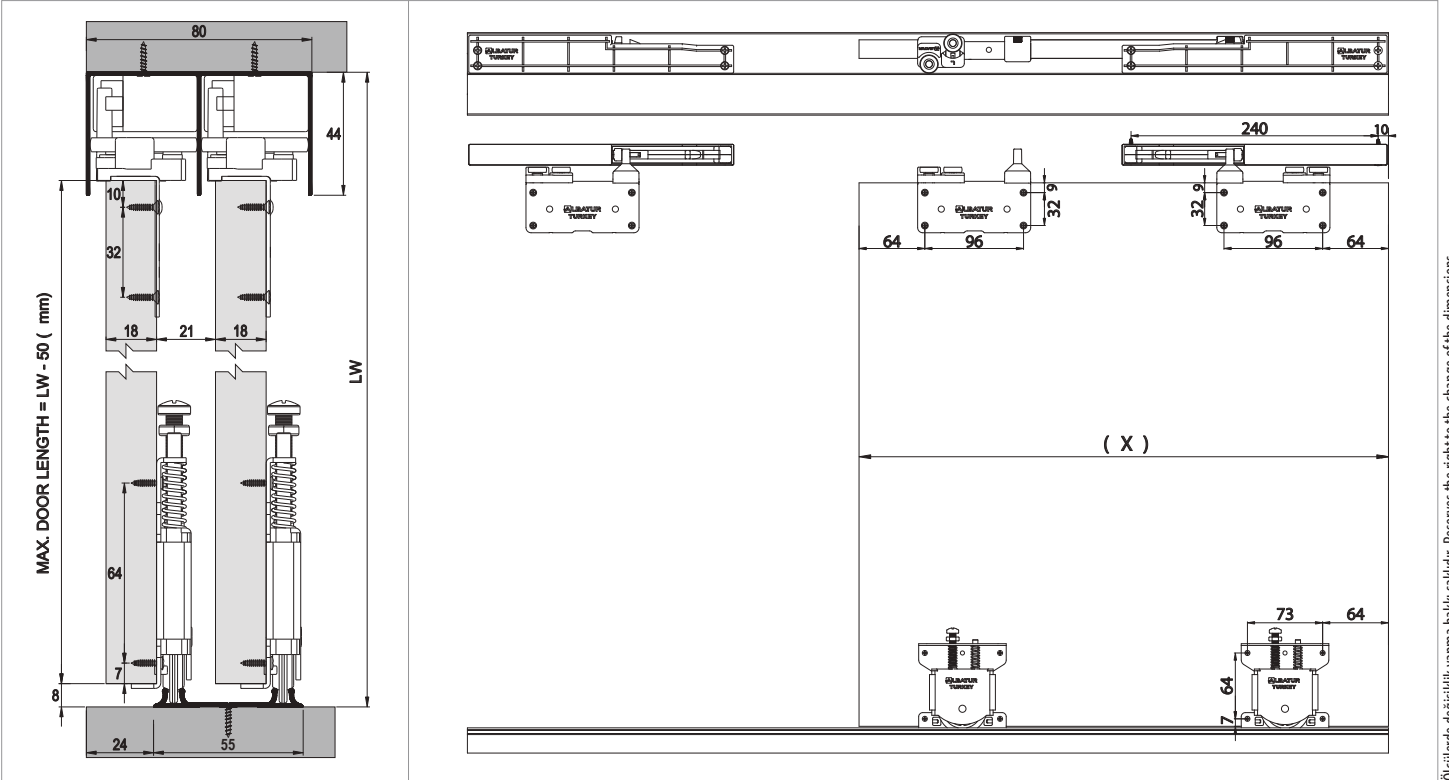

Ölçülerde değişiklik yapma hakkı saklıdır. Reserves the right to the change of the dimensions.

| Kod / Code No | Açıklama / Description | Renk / Colour | Birim / Unit | | | Profil mt. / Profiles mt. | | | Bağ / Bnd. |
|---------------|---|------------------------|-----------------|-------|---------|---------------------------|-----|-----|------------|
| 103-0115-1200 | Multiline SRG 115 - 70 Kg Sürme Kapak Sistemi / Sliding Door System | Silver | 2 Kapak / 1 Set | 12 | 216 | - | - | - | - |
| 117-1011-1600 | Plastik Ray Tapası / Plastic Rail Cap | Gri / Grey | 1 Adet / 1 Pcs | 1.000 | 120.000 | - | - | - | - |
| 150-2960-1410 | Alüminyum Üst Ray Profili / Aluminium Top Rail Profile | Eloksal / Mat Anodized | mt. | - | - | 2,0 | 2,5 | 3,0 | 6 ad/pcs |
| 150-7108-1410 | Alüminyum Alt Ray Profili / Aluminium Bottom Rail Profile | Eloksal / Mat Anodized | mt. | - | - | 2,0 | 2,5 | 3,0 | 12 ad/pcs |
| 150-2900-1420 | Alüminyum Kulp Profili / Aluminium Handle Profile | Parlak / Bright | mt. | - | - | - | 2,5 | - | 6 ad/pcs |
| 150-1420-1420 | Alüminyum Kapama Profili / Aluminium Closure Profile | Parlak / Bright | mt. | - | - | - | - | 3,0 | 10 ad/pcs |



Bilgi / Information

- 1 Kutu İçeriği : 2 Kapak Mekanizma + 4 Ad Yavaşlatıcı
- In 1 box : 2 Door Mechanism + 4 Pcs Soft Closers

- 3 Kapaklı Dolap Uygulaması
- 3 Door Wardrobe Application



103-0210 1 Set İçeriği / 1 Set Includes

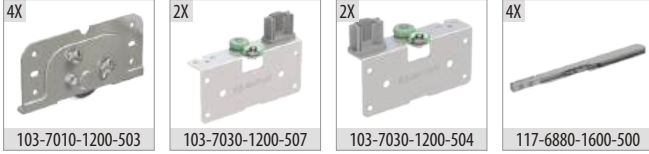

103-0213 Opsiyonel 3. İç Kapak / Optional 3. Internal Door

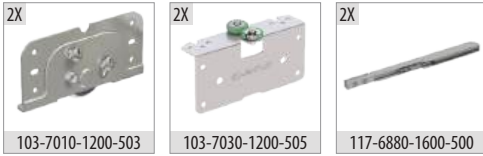

Ray Profilleri / Rail Profiles

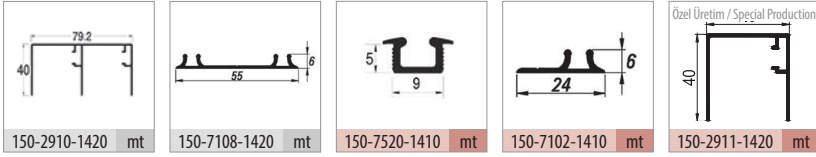

Kulp Profilleri / Handle Profiles

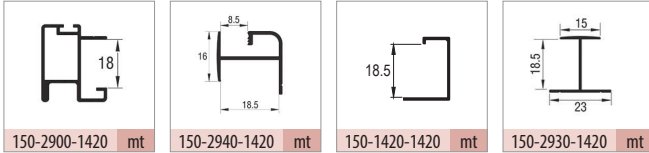

Opsiyonel Aksesuar / Optional Accessories

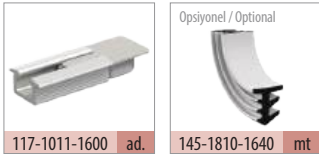

Teknik Detay / Technical Detail

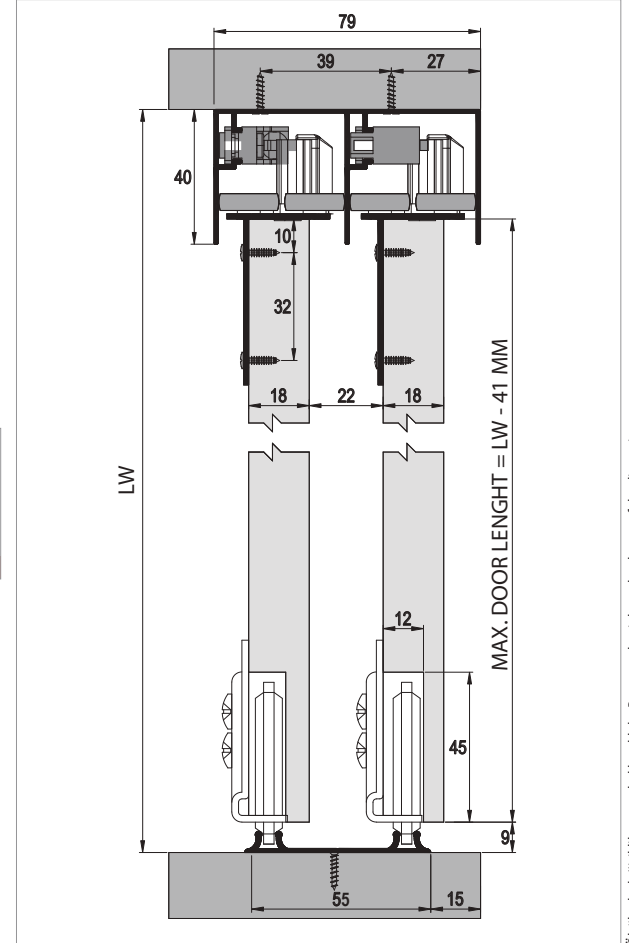

Ölçülerde değişiklik yapma hakkı saklıdır. Reserves the right to the change of the dimensions.

| Kod / Code No | Açıklama / Description | Renk / Colour | Birim / Unit | | | Profil mt. / Profiles mt. | Bağ / Bnd. |
|---------------|--|---------------------|-----------------|-----|-------|---------------------------|------------|
| 103-0210-1200 | SRG 210 - Sürme Kapak Sistemi / Sliding Door System | Silver | 2 Kapak / 1 Set | 12 | 360 | - - - | - |
| 103-0213-1200 | SRG 210 C - Sürme Kapak Sistemi 3. Kapak / Sliding Door System 3. Door | Silver | 1 Kapak / 1 Kit | 12 | 360 | - - - | - |
| 145-1810-1640 | Cam Fitolu / Glass Wick | Şeffaf / Transparan | mt. | 100 | 3.600 | - - - | - |
| 150-2910-1420 | Alüminyum Üst Ray Profili / Aluminium Top Rail Profile | Parlak / Bright | mt. | - | - | 2,0 2,5 3,0 | 6 ad/pcs |
| 150-7108-1420 | Alüminyum Alt Ray Profili / Aluminium Bottom Rail Profile | Parlak / Bright | mt. | - | - | 2,0 2,5 3,0 | 12 ad/pcs |
| 150-2900-1420 | Alüminyum Kulp Profili / Aluminium Handle Profile | Parlak / Bright | mt. | - | - | 2,0 2,5 3,0 | 6 ad/pcs |
| 150-2940-1420 | Alüminyum Orta Kayıt / Aluminium Horizontal Central | Parlak / Bright | mt. | - | - | - - 3,0 | 10 ad/pcs |
| 150-1420-1420 | Alüminyum Kapama Profili / Aluminium Closure Profile | Parlak / Bright | mt. | - | - | - - 3,0 | 10 ad/pcs |
| 150-2930-1420 | Alüminyum Orta Kayıt / Aluminium Horizontal Central | Parlak / Bright | mt. | - | - | - - 3,0 | 10 ad/pcs |



Multiline **SRG 210**

80 KG SÜRME KAPAK SİSTEMİ • SLIDING DOOR SYSTEM

albaturas.com

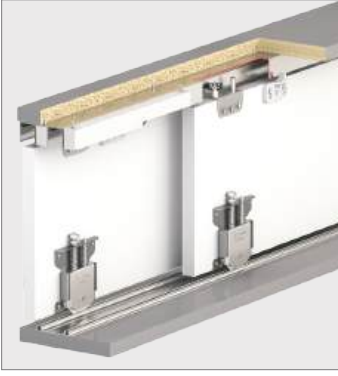

Bilgi / Information

- 1 Kutu İçeriği : 2 Kapak Mekanizma + 4 Ad Yavaşlatıcı
- In 1 box : 2 Door Mechanism + 4 Pcs Soft Closers



103-0120 1 Set İçeriği / 1 Set Includes

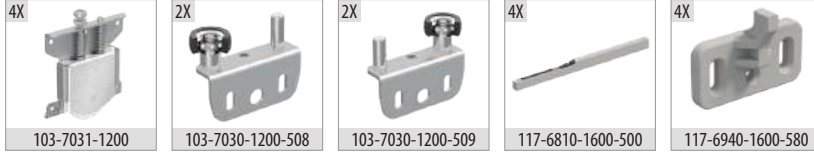

Ray Profilleri / Rail Profiles

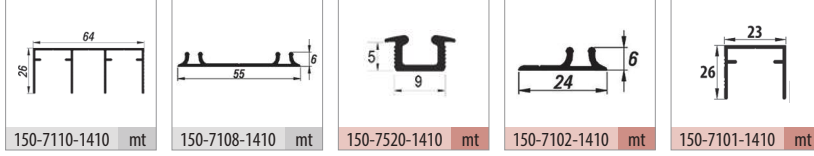

Kulp Profilleri / Handle Profiles

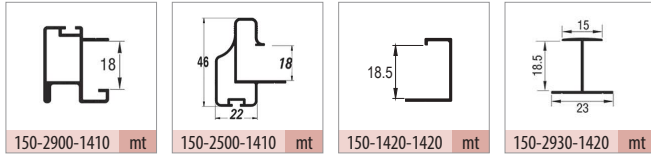

Opsiyonel Aksesuar / Optional Accessories



Teknik Detay / Technical Detail

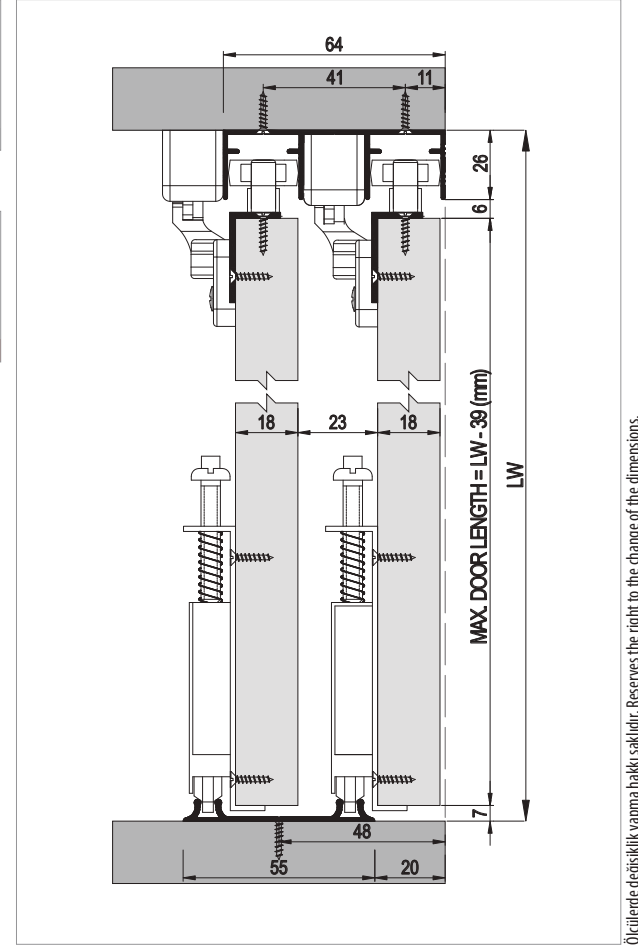

Ölçülerde değişiklik yapma hakkı saklıdır. Reserves the right to the change of the dimensions.

| Kod / Code No | Açıklama / Description | Renk / Colour | Birim / Unit | | | Profil mt. / Profiles mt. | | | Bağ / Bnd. |
|---------------|---|------------------------|-----------------|-------|---------|---------------------------|-----|-----|------------|
| 103-0120-1200 | SRG 120 - Sürme Kapak Sistemi / Sliding Door System | Silver | 2 Kapak / 1 Set | 12 | 216 | - | - | - | - |
| 117-1011-1600 | Plastik Ray Tapası / Plastic Rail Cap | Gri / Grey | 1 Adet / 1 Pcs | 1.000 | 120.000 | - | - | - | - |
| 150-7110-1410 | Alüminyum Üst Ray Profili / Aluminium Top Rail Profile | Eloksal / Mat Anodized | mt. | - | - | 2,0 | 2,5 | 3,0 | 6 ad/pcs |
| 150-7108-1410 | Alüminyum Alt Ray Profili / Aluminium Bottom Rail Profile | Eloksal / Mat Anodized | mt. | - | - | 2,0 | 2,5 | 3,0 | 12 ad/pcs |
| 150-7520-1410 | Alüminyum Alt Ray Profili / Aluminium Bottom Rail Profile | Eloksal / Mat Anodized | mt. | - | - | - | - | 3,0 | 30 ad/pcs |
| 150-7102-1410 | Alüminyum Alt Ray Profili / Aluminium Bottom Rail Profile | Eloksal / Mat Anodized | mt. | - | - | - | - | 3,0 | 20 ad/pcs |
| 150-7101-1410 | Alüminyum Üst Ray Profili / Aluminium Top Rail Profile | Eloksal / Mat Anodized | mt. | - | - | - | - | 3,0 | 12 ad/pcs |
| 150-2900-1410 | Alüminyum Kulp Profili / Aluminium Handle Profile | Eloksal / Mat Anodized | mt. | - | - | 2,0 | - | 3,0 | 6 ad/pcs |
| 150-2500-1410 | Alüminyum Kulp Profili / Aluminium Handle Profile | Eloksal / Mat Anodized | mt. | - | - | 2,0 | - | 3,0 | 6 ad/pcs |
| 150-1420-1420 | Alüminyum Kapama Profili / Aluminium Closure Profile | Parlak / Bright | mt. | - | - | - | - | 3,0 | 10 ad/pcs |
| 150-2930-1420 | Alüminyum Orta Kayıt / Aluminium Horizontal Central | Parlak / Bright | mt. | - | - | - | - | 3,0 | 10 ad/pcs |

Multiline SRG 125

70 KG SÜRME KAPAK SİSTEMİ • SLIDING DOOR SYSTEM



Bilgi / Information

- 1 Kutu İçeriği : 2 Kapak Mekanizma + 4 Ad Yavaşlatıcı
- In 1 box : 2 Door Mechanism + 4 Pcs Soft Closers



103-0125 1 Set İçeriği / 1 Set Includes

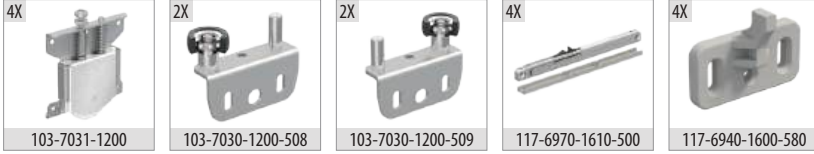

Ray Profilleri / Rail Profiles

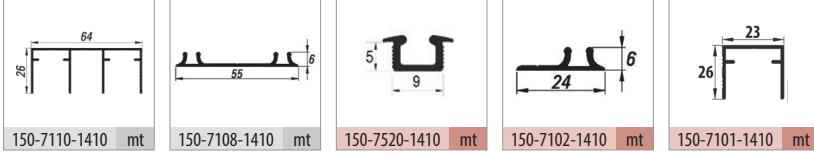

Kulp Profilleri / Handle Profiles

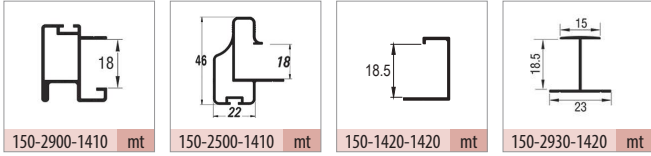

Opsiyonel Aksesuar / Optional Accessories



Teknik Detay / Technical Detail

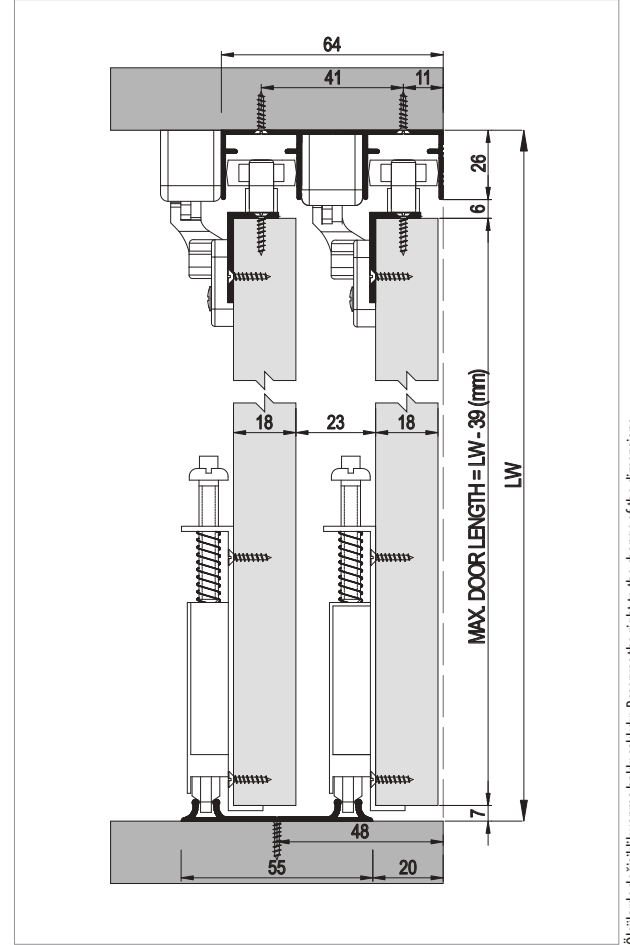

Ölçülerde değişiklik yapma hakkı saklıdır. Reserves the right to the change of the dimensions.

| Kod / Code No | Açıklama / Description | Renk / Colour | Birim / Unit | | | Profil mt. / Profiles mt. | | | Bağ / Bnd. |
|---------------|---|------------------------|-----------------|-------|---------|---------------------------|-----|-----|------------|
| 103-0125-1200 | SRG 125 - Sürme Kapak Sistemi / Sliding Door System | Silver | 2 Kapak / 1 Set | 12 | 360 | - | - | - | - |
| 117-1011-1600 | Plastik Ray Tapası / Plastic Rail Cap | Gri / Grey | 1 Adet / 1 Pcs | 1.000 | 120.000 | - | - | - | - |
| 150-7110-1410 | Alüminyum Üst Ray Profili / Aluminium Top Rail Profile | Eloksal / Mat Anodized | mt. | - | - | 2,0 | 2,5 | 3,0 | 6 ad/pcs |
| 150-7108-1410 | Alüminyum Alt Ray Profili / Aluminium Bottom Rail Profile | Eloksal / Mat Anodized | mt. | - | - | 2,0 | 2,5 | 3,0 | 12 ad/pcs |
| 150-7520-1410 | Alüminyum Alt Ray Profili / Aluminium Bottom Rail Profile | Eloksal / Mat Anodized | mt. | - | - | - | - | 3,0 | 30 ad/pcs |
| 150-7102-1410 | Alüminyum Alt Ray Profili / Aluminium Bottom Rail Profile | Eloksal / Mat Anodized | mt. | - | - | - | - | 3,0 | 20 ad/pcs |
| 150-7101-1410 | Alüminyum Üst Ray Profili / Aluminium Top Rail Profile | Eloksal / Mat Anodized | mt. | - | - | - | - | 3,0 | 12 ad/pcs |
| 150-2900-1410 | Alüminyum Kulp Profili / Aluminium Handle Profile | Eloksal / Mat Anodized | mt. | - | - | 2,0 | - | 3,0 | 6 ad/pcs |
| 150-2500-1410 | Alüminyum Kulp Profili / Aluminium Handle Profile | Eloksal / Mat Anodized | mt. | - | - | 2,0 | - | 3,0 | 6 ad/pcs |
| 150-1420-1420 | Alüminyum Kapama Profili / Aluminium Closure Profile | Parlak / Bright | mt. | - | - | - | - | 3,0 | 10 ad/pcs |
| 150-2930-1420 | Alüminyum Orta Kayıt / Aluminium Horizontal Central | Parlak / Bright | mt. | - | - | - | - | 3,0 | 10 ad/pcs |

Multiline SRG 130

60 KG SÜRME KAPAK SİSTEMİ • SLIDING DOOR SYSTEM



Bilgi / Information

- 1 Kutu İçeriği : 2 Kapak Mekanizma + 4 Ad Yavaşlatıcı
- In 1 box : 2 Door Mechanism + 4 Pcs Soft Closers



103-0130 1 Set İçeriği / 1 Set Includes

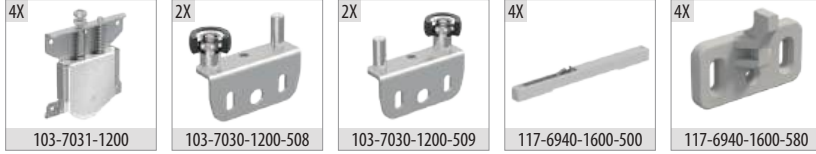

Ray Profilleri / Rail Profiles

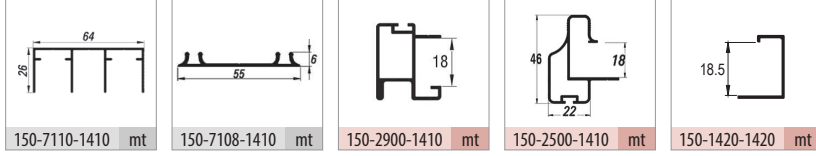

Kulp Profilleri / Handle Profiles

Teknik Detay / Technical Detail

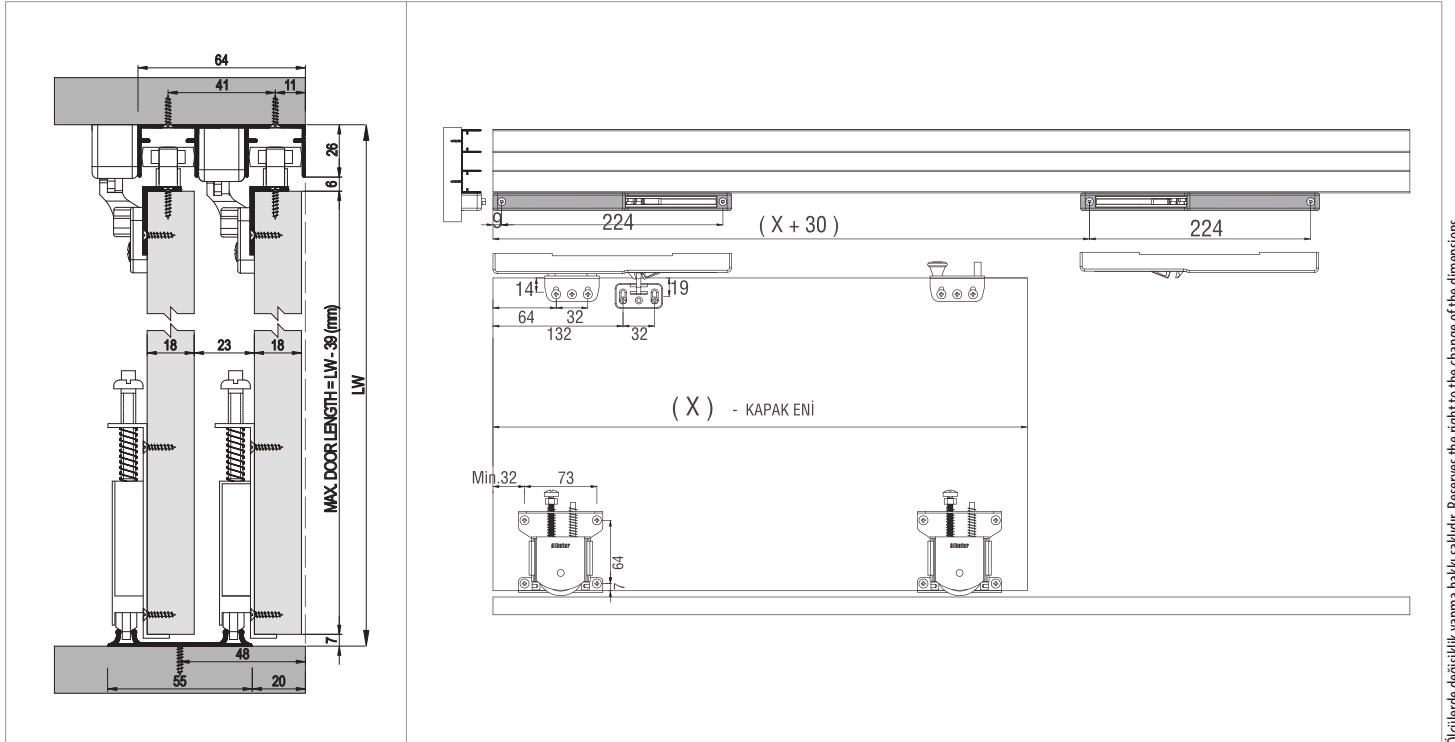

Ölçülerde değişiklik yapma hakkı saklıdır. Reserves the right to the change of the dimensions.

| Kod / Code No | Açıklama / Description | Renk / Colour | Birim / Unit | | | Profil mt. / Profiles mt. | Bağ / Bnd. | | |
|---------------|---|------------------------|-----------------|----|-----|---------------------------|------------|-----|-----------|
| 103-0130-1200 | SRG 130 - Sürme Kapak Sistemi / Sliding Door System | Silver | 2 Kapak / 1 Set | 12 | 360 | - | - | | |
| 150-7110-1410 | Alüminyum Üst Ray Profili / Aluminium Top Rail Profile | Eloksal / Mat Anodized | mt. | - | - | 2,0 | 2,5 | 3,0 | 6 ad/pcs |
| 150-7108-1410 | Alüminyum Alt Ray Profili / Aluminium Bottom Rail Profile | Eloksal / Mat Anodized | mt. | - | - | 2,0 | 2,5 | 3,0 | 12 ad/pcs |
| 150-2900-1410 | Alüminyum Kulp Profili / Aluminium Handle Profile | Eloksal / Mat Anodized | mt. | - | - | 2,0 | - | 3,0 | 6 ad/pcs |
| 150-2500-1410 | Alüminyum Kulp Profili / Aluminium Handle Profile | Eloksal / Mat Anodized | mt. | - | - | 2,0 | - | 3,0 | 6 ad/pcs |
| 150-1420-1420 | Alüminyum Kapama Profili / Aluminium Closure Profile | Parlak / Bright | mt. | - | - | - | - | 3,0 | 10 ad/pcs |

Multiline SRG 135

60 KG SÜRME KAPAK SİSTEMİ • SLIDING DOOR SYSTEM



Bilgi / Information

- 1 Kutu İçeriği : 2 Kapak Mekanizma + 4 Ad Yavaşlatıcı
- In 1 box : 2 Door Mechanism + 4 Pcs Soft Closers



103-0135 1 Set İçeriği / 1 Set Includes

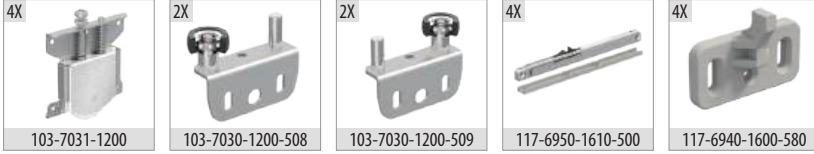

Ray Profilleri / Rail Profiles

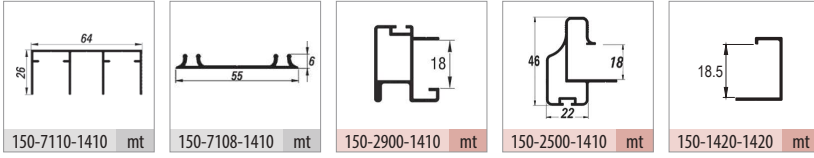

Kulp Profilleri / Handle Profiles

Teknik Detay / Technical Detail

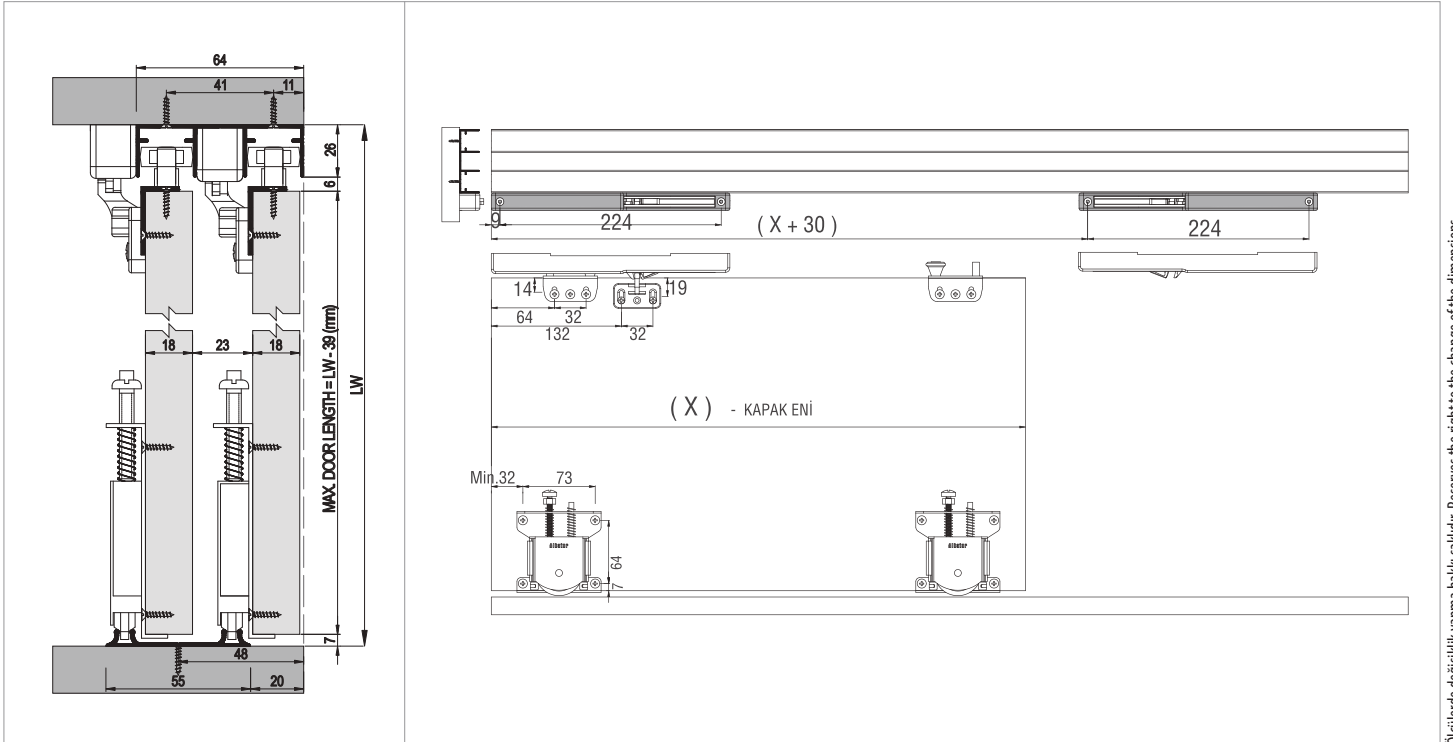

Ölçülerde değişiklik yapma hakkı saklıdır. Reserves the right to the change of the dimensions.

| Kod / Code No | Açıklama / Description | Renk / Colour | Birim / Unit | | | Profil mt. / Profiles mt. | | | Bağ / Bnd. |
|---------------|---|------------------------|-----------------|----|-----|---------------------------|-----|-----|------------|
| 103-0135-1200 | SRG 135 - Sürme Kapak Sistemi / Sliding Door System | Silver | 2 Kapak / 1 Set | 12 | 360 | - | - | - | - |
| 150-7110-1410 | Alüminyum Üst Ray Profili / Aluminium Top Rail Profile | Eloksal / Mat Anodized | mt. | - | - | 2,0 | 2,5 | 3,0 | 6 ad/pcs |
| 150-7108-1410 | Alüminyum Alt Ray Profili / Aluminium Bottom Rail Profile | Eloksal / Mat Anodized | mt. | - | - | 2,0 | 2,5 | 3,0 | 12 ad/pcs |
| 150-2900-1410 | Alüminyum Kulp Profili / Aluminium Handle Profile | Eloksal / Mat Anodized | mt. | - | - | 2,0 | - | 3,0 | 6 ad/pcs |
| 150-2500-1410 | Alüminyum Kulp Profili / Aluminium Handle Profile | Eloksal / Mat Anodized | mt. | - | - | 2,0 | - | 3,0 | 6 ad/pcs |
| 150-1420-1420 | Alüminyum Kapama Profili / Aluminium Closure Profile | Parlak / Bright | mt. | - | - | - | - | 3,0 | 10 ad/pcs |



Bilgi / Information

- 1 Kutu İçeriği : 2 Kapak Mekanizma + 4 Ad Yavaşlatıcı
- In 1 box : 2 Door Mechanism + 4 Pcs Soft Closers



103-0140 1 Set İçeriği / 1 Set Includes



Ray Profilleri / Rail Profiles

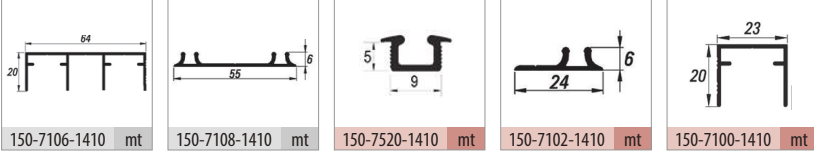

Kulp Profilleri / Handle Profiles

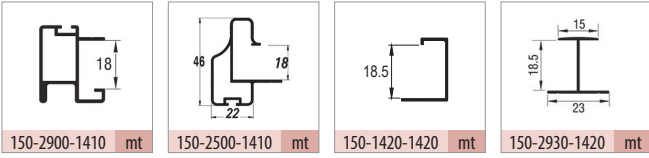

Opsiyonel Aksesuar / Optional Accessories



Teknik Detay / Technical Detail

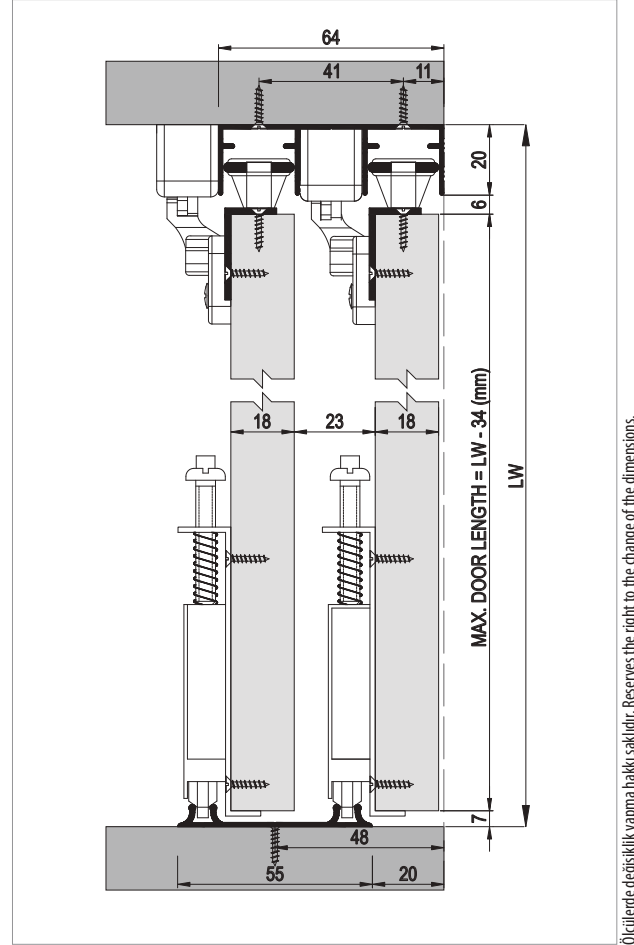

| Kod / Code No | Açıklama / Description | Renk / Colour | Birim / Unit | | | Profil mt. / Profiles mt. | | | Bağ / Bnd. |
|---------------|---|------------------------|-----------------|-------|---------|---------------------------|-----|-----|------------|
| 103-0140-1200 | SRG 140 - Sürme Kapak Sistemi / Sliding Door System | Silver | 2 Kapak / 1 Set | 12 | 360 | - | - | - | - |
| 117-1011-1600 | Plastik Ray Tapası / Plastic Rail Cap | Gri / Grey | 1 Adet / 1 Pcs | 1.000 | 120.000 | - | - | - | - |
| 150-7106-1410 | Alüminyum Üst Ray Profili / Aluminium Top Rail Profile | Eloksal / Mat Anodized | mt. | - | - | 2,0 | 2,5 | 3,0 | 6 ad/pcs |
| 150-7108-1410 | Alüminyum Alt Ray Profili / Aluminium Bottom Rail Profile | Eloksal / Mat Anodized | mt. | - | - | 2,0 | 2,5 | 3,0 | 12 ad/pcs |
| 150-7520-1410 | Alüminyum Alt Ray Profili / Aluminium Bottom Rail Profile | Eloksal / Mat Anodized | mt. | - | - | - | - | 3,0 | 30 ad/pcs |
| 150-7102-1410 | Alüminyum Alt Ray Profili / Aluminium Bottom Rail Profile | Eloksal / Mat Anodized | mt. | - | - | - | - | 3,0 | 20 ad/pcs |
| 150-7100-1410 | Alüminyum Üst Ray Profili / Aluminium Top Rail Profile | Eloksal / Mat Anodized | mt. | - | - | - | - | 3,0 | 12 ad/pcs |
| 150-2900-1410 | Alüminyum Kulp Profili / Aluminium Handle Profile | Eloksal / Mat Anodized | mt. | - | - | 2,0 | - | 3,0 | 6 ad/pcs |
| 150-2500-1410 | Alüminyum Kulp Profili / Aluminium Handle Profile | Eloksal / Mat Anodized | mt. | - | - | 2,0 | - | 3,0 | 6 ad/pcs |
| 150-1420-1420 | Alüminyum Kapama Profili / Aluminium Closure Profile | Parlak / Bright | mt. | - | - | - | - | 3,0 | 10 ad/pcs |
| 150-2930-1420 | Alüminyum Orta Kayıt / Aluminium Horizontal Central | Parlak / Bright | mt. | - | - | - | - | 3,0 | 10 ad/pcs |

Multiline SRG 145

60 KG SÜRME KAPAK SİSTEMİ • SLIDING DOOR SYSTEM



Bilgi / Information

- 1 Kutu İçeriği : 2 Kapak Mekanizma + 4 Ad Yavaşlatıcı
- In 1 box : 2 Door Mechanism + 4 Pcs Soft Closers



103-0145 1 Set İçeriği / 1 Set Includes



Ray Profilleri / Rail Profiles

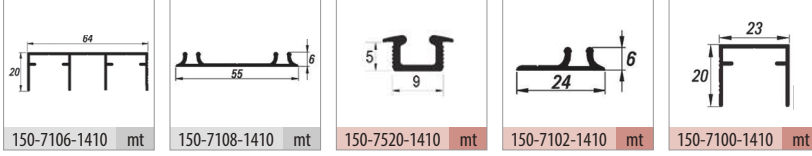

Kulp Profilleri / Handle Profiles

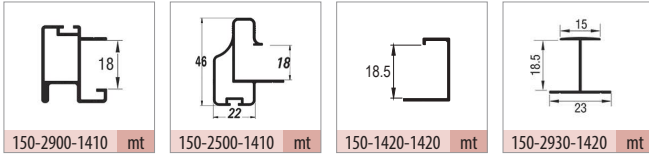

Opsiyonel Aksesuar / Optional Accessories



Teknik Detay / Technical Detail

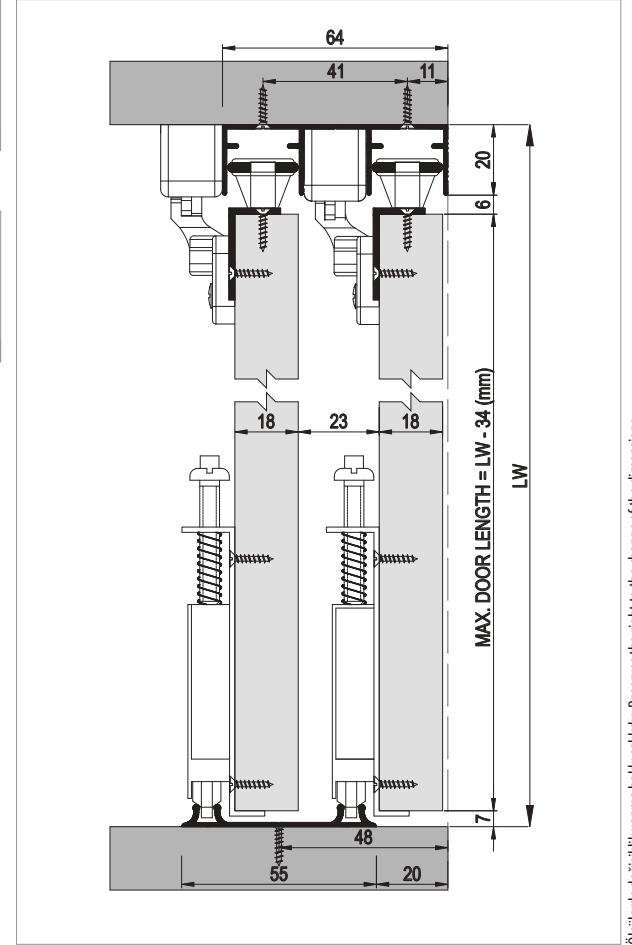

Ölçülerde değişiklik yapma hakkı saklıdır. Reserves the right to the change of the dimensions.

| Kod / Code No | Açıklama / Description | Renk / Colour | Birim / Unit | | | Profil mt. / Profiles mt. | | | Bağ / Bnd. |
|---------------|---|------------------------|-----------------|-------|---------|---------------------------|-----|-----|------------|
| 103-0145-1200 | SRG 145 - Sürme Kapak Sistemi / Sliding Door System | Silver | 2 Kapak / 1 Set | 12 | 360 | - | - | - | - |
| 117-1011-1600 | Plastik Ray Tapası / Plastic Rail Cap | Gri / Grey | 1 Adet / 1 Pcs | 1.000 | 120.000 | - | - | - | - |
| 150-7106-1410 | Alüminyum Üst Ray Profili / Aluminium Top Rail Profile | Eloksal / Mat Anodized | mt. | - | - | 2,0 | 2,5 | 3,0 | 6 ad/pcs |
| 150-7108-1410 | Alüminyum Alt Ray Profili / Aluminium Bottom Rail Profile | Eloksal / Mat Anodized | mt. | - | - | 2,0 | 2,5 | 3,0 | 12 ad/pcs |
| 150-7520-1410 | Alüminyum Alt Ray Profili / Aluminium Bottom Rail Profile | Eloksal / Mat Anodized | mt. | - | - | - | - | 3,0 | 30 ad/pcs |
| 150-7102-1410 | Alüminyum Alt Ray Profili / Aluminium Bottom Rail Profile | Eloksal / Mat Anodized | mt. | - | - | - | - | 3,0 | 20 ad/pcs |
| 150-7100-1410 | Alüminyum Üst Ray Profili / Aluminium Top Rail Profile | Eloksal / Mat Anodized | mt. | - | - | - | - | 3,0 | 12 ad/pcs |
| 150-2900-1410 | Alüminyum Kulp Profili / Aluminium Handle Profile | Eloksal / Mat Anodized | mt. | - | - | 2,0 | - | 3,0 | 6 ad/pcs |
| 150-2500-1410 | Alüminyum Kulp Profili / Aluminium Handle Profile | Eloksal / Mat Anodized | mt. | - | - | 2,0 | - | 3,0 | 6 ad/pcs |
| 150-1420-1420 | Alüminyum Kapama Profili / Aluminium Closure Profile | Parlak / Bright | mt. | - | - | - | - | 3,0 | 10 ad/pcs |
| 150-2930-1420 | Alüminyum Orta Kayıt / Aluminium Horizontal Central | Parlak / Bright | mt. | - | - | - | - | 3,0 | 10 ad/pcs |

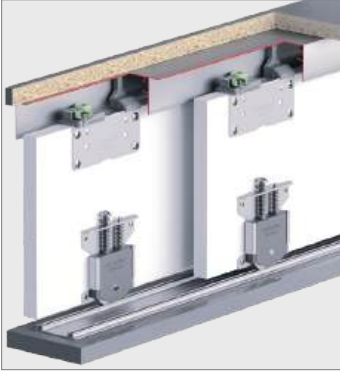

Bilgi / Information

- 1 Kutu İçeriği : 2 Kapak Mekanizma
- In 1 box : 2 Door Mechanism

- 3 Kapaklı Dolap Uygulaması
- 3 Door Wardrobe Application



Yavaşlatıcı Alternatifi / Soft Closer Alternative

117-6740-1610 <<>>

103-7036 1 Takım İçeriği / 1 Kit Includes

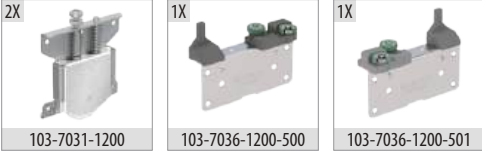

Ray Profilleri / Rail Profiles

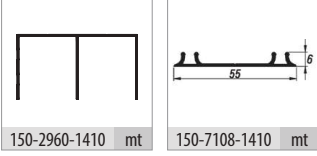

Kulp / Handle Profiles

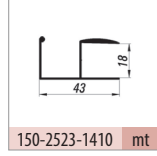

Opsiyonel / Optional



Teknik Detay / Technical Detail

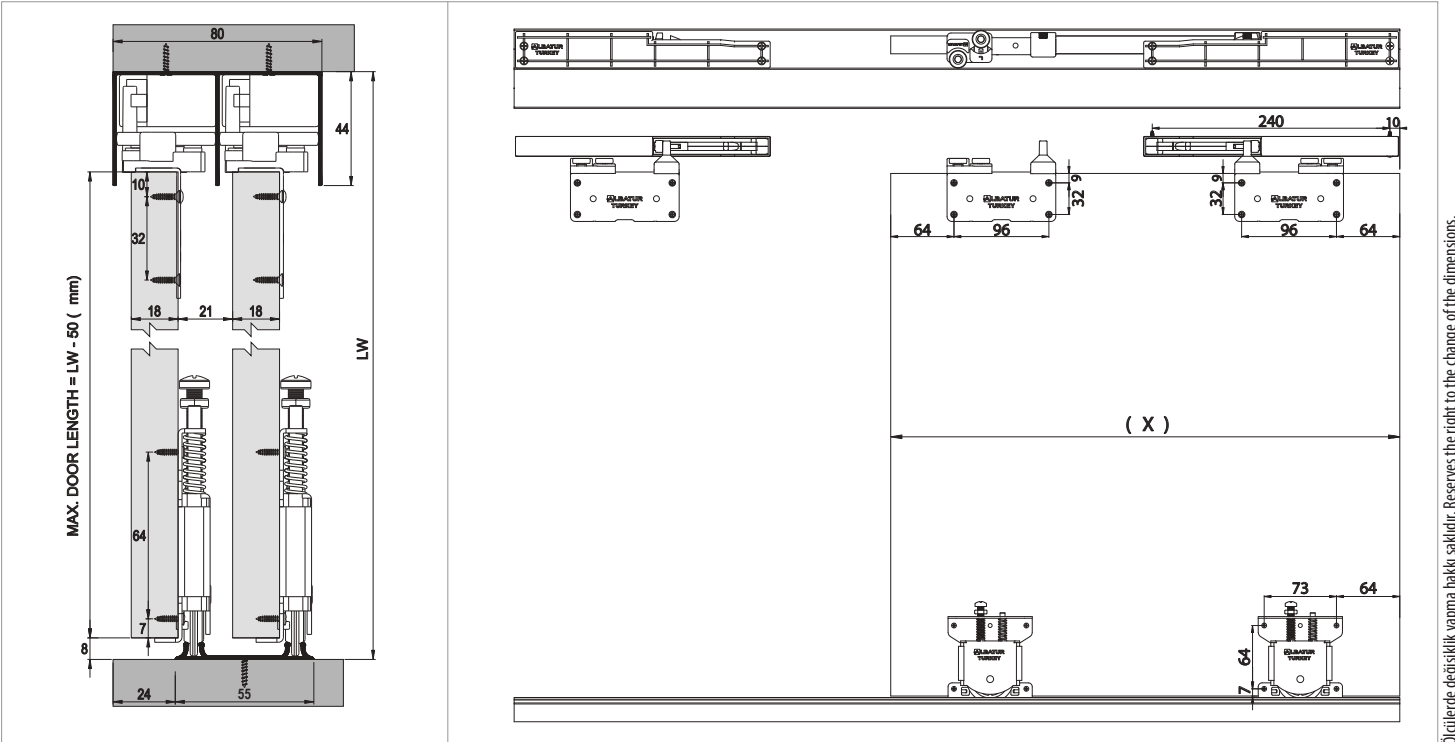

Ölçülerde değişiklik yapma hakkı saklıdır. Reserves the right to the change of the dimensions.

| Kod / Code No | Açıklama / Description | Renk / Colour | Birim / Unit | | | Profil mt. / Profiles mt. | Bağ / Bnd. |
|---------------|---|------------------------|-----------------|-------|---------|---------------------------|------------|
| 103-7036-1200 | 7036 - 70 Kg Sürme Kapak Sistemi / Sliding Door System | Silver | 1 Kapak / 1 Kit | 24 | 720 | - - - | - |
| 117-1011-1600 | Plastik Ray Tapası / Plastic Rail Cap | Gri / Grey | 1 Adet / 1 Pcs | 1.000 | 120.000 | - - - | - |
| 150-2960-1410 | Alüminyum Üst Ray Profili / Aluminium Top Rail Profile | Eloksal / Mat Anodized | mt. | - | - | 2,0 2,5 3,0 | 6 ad/pcs |
| 150-7108-1410 | Alüminyum Alt Ray Profili / Aluminium Bottom Rail Profile | Eloksal / Mat Anodized | mt. | - | - | 2,0 2,5 3,0 | 12 ad/pcs |
| 150-2523-1410 | Alüminyum Kulp Profili / Aluminium Handle Profile | Eloksal / Mat Anodized | mt. | - | - | - 2,5 - | 10 ad/pcs |
| 150-1420-1420 | Alüminyum Kapama Profili / Aluminium Closure Profile | Parlak / Bright | mt. | - | - | - - 3,0 | 10 ad/pcs |

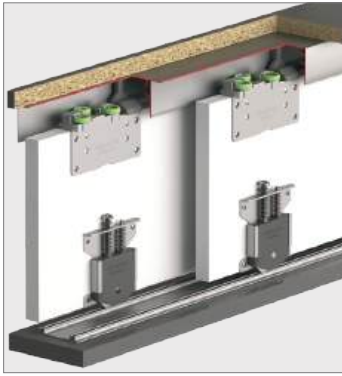

Bilgi / Information

- 1 Kutu İçeriği : 2 Kapak Mekanizma
- In 1 box : 2 Door Mechanism

- 3 Kapaklı Dolap Uygulaması
- 3 Door Wardrobe Application



Yavaşlatıcı Alternatifi / Soft Closer Alternative

117-6740-1610 <<>>

103-7038 1 Takım İçeriği / 1 Kit Includes



Ray Profilleri / Rail Profiles

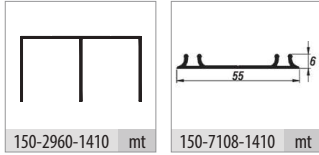

Kulp / Handle Profiles

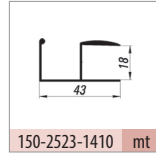

Opsiyonel / Optional

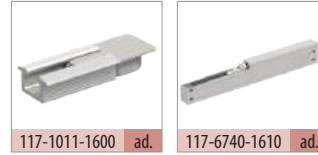

Teknik Detay / Technical Detail

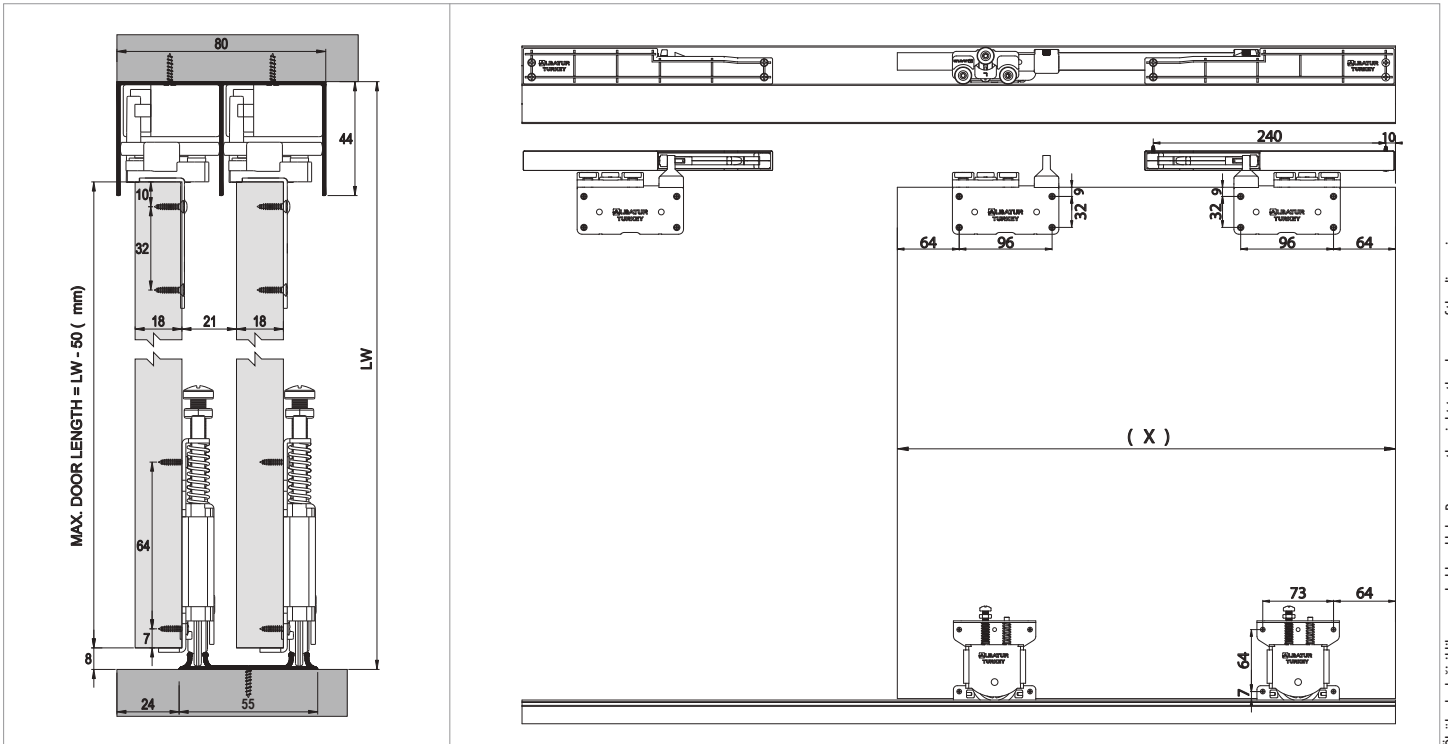

Ölçülerde değişiklik yapma hakkı saklıdır. Reserves the right to the change of the dimensions.

| Kod / Code No | Açıklama / Description | Renk / Colour | Birim / Unit | | | Profil mt. / Profiles mt. | Bağ / Bnd. |
|---------------|---|------------------------|-----------------|-------|---------|---------------------------|------------|
| 103-7038-1200 | 7038 - 70 Kg Sürme Kapak Sistemi / Sliding Door System | Silver | 1 Kapak / 1 Kit | 24 | 720 | - - - | - |
| 117-1011-1600 | Plastik Ray Tapası / Plastic Rail Cap | Gri / Grey | 1 Adet / 1 Pcs | 1.000 | 120.000 | - - - | - |
| 150-2960-1410 | Alüminyum Üst Ray Profili / Aluminium Top Rail Profile | Eloksal / Mat Anodized | mt. | - | - | 2,0 2,5 3,0 | 6 ad/pcs |
| 150-7108-1410 | Alüminyum Alt Ray Profili / Aluminium Bottom Rail Profile | Eloksal / Mat Anodized | mt. | - | - | 2,0 2,5 3,0 | 12 ad/pcs |
| 150-2523-1410 | Alüminyum Kulp Profili / Aluminium Handle Profile | Eloksal / Mat Anodized | mt. | - | - | - 2,5 - | 10 ad/pcs |
| 150-1420-1420 | Alüminyum Kapama Profili / Aluminium Closure Profile | Parlak / Bright | mt. | - | - | - - 3,0 | 10 ad/pcs |

Multiline 7030

75 KG SÜRME KAPAK SİSTEMİ • SLIDING DOOR SYSTEM



Bilgi / Information

- 1 Kutu İçeriği : 2 Kapak Mekanizma
- In 1 box : 2 Door Mechanism

Yavaşlatıcı Alternatifi / Soft Closer Alternative

- 117-6942-1610 <<>>
- 117-6950-1610 <<>>
- 117-6970-1610 <<>>
- 117-6940-1600 <<>>
- 117-6666-1610 >>
- 117-6710-1610 >>



103-7030 1 Takım İçeriği / 1 Kit Includes

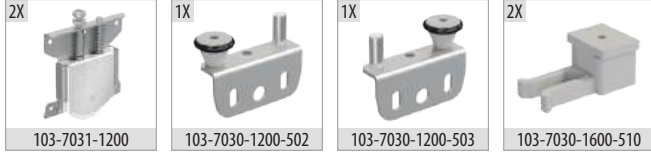

Ray Profilleri / Rail Profiles

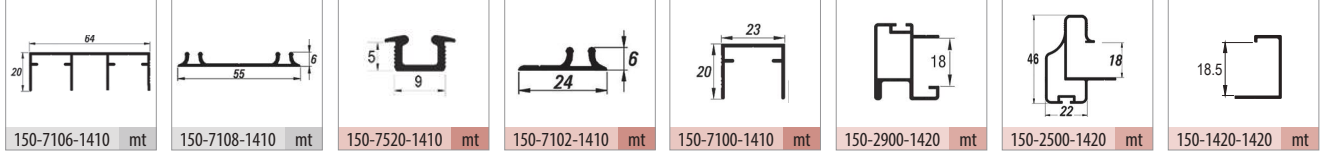

Kulp Profilleri / Handle Profiles

Teknik Detay / Technical Detail

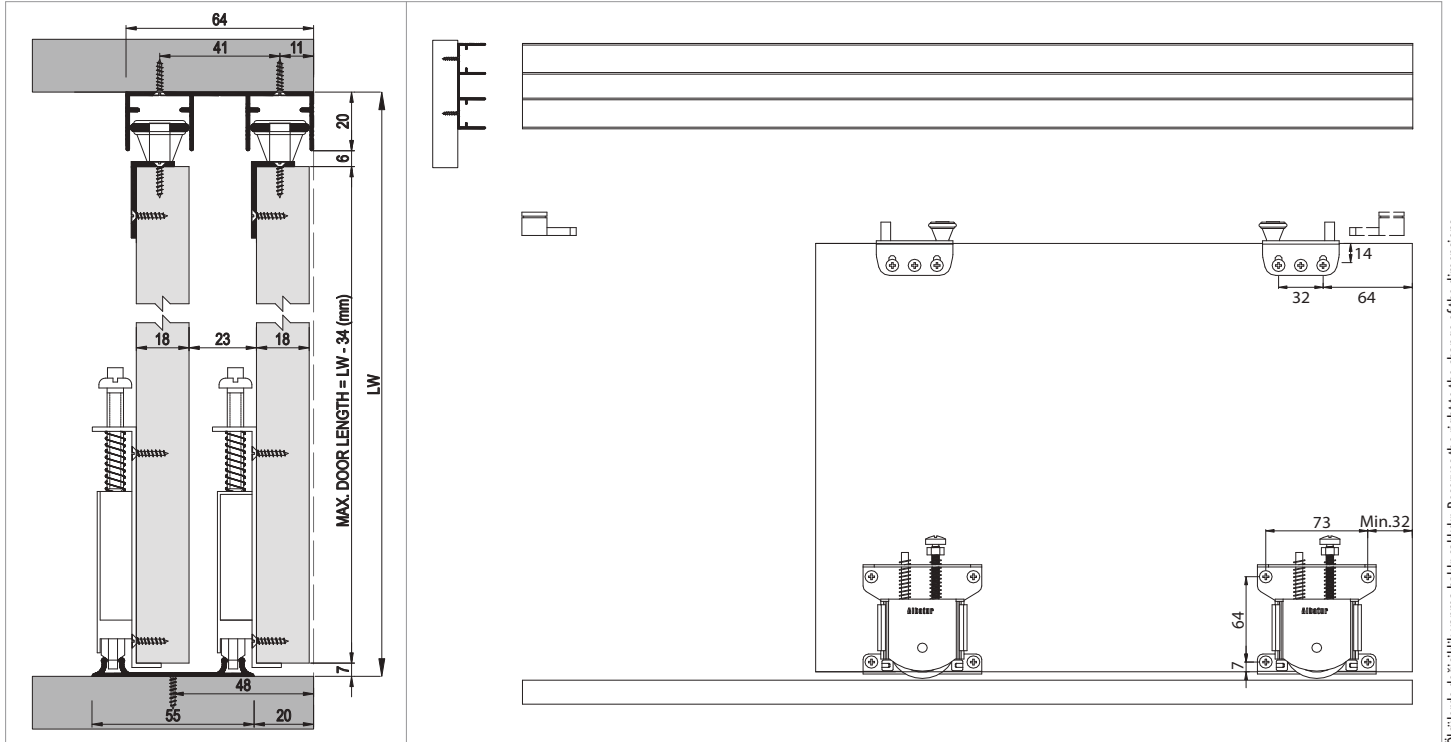

Ölçülerde değişiklik yapma hakkı saklıdır. Reserves the right to the change of the dimensions.

| Kod / Code No | Açıklama / Description | Renk / Colour | Birim / Unit | | | Profil mt. / Profiles mt. | | | Bağ / Bnd. |
|---------------|---|------------------------|-----------------|----|-------|---------------------------|-----|-----|------------|
| 103-7030-1200 | 7030 - Sürme Kapak Sistemi / Sliding Door System | Silver | 1 Kapak / 1 Kit | 32 | 1.024 | - | - | - | - |
| 150-7106-1410 | Alüminyum Üst Ray Profili / Aluminium Top Rail Profile | Eloksal / Mat Anodized | mt. | - | - | 2,0 | 2,5 | 3,0 | 6 ad/pcs |
| 150-7108-1410 | Alüminyum Alt Ray Profili / Aluminium Bottom Rail Profile | Eloksal / Mat Anodized | mt. | - | - | 2,0 | 2,5 | 3,0 | 12 ad/pcs |
| 150-2900-1420 | Alüminyum Kulp Profili / Aluminium Handle Profile | Parlak / Bright | mt. | - | - | 2,0 | 2,5 | 3,0 | 6 ad/pcs |
| 150-2500-1420 | Alüminyum Kulp Profili / Aluminium Handle Profile | Parlak / Bright | mt. | - | - | 2,0 | - | 3,0 | 6 ad/pcs |
| 150-1420-1420 | Alüminyum Kapama Profili / Aluminium Closure Profile | Parlak / Bright | mt. | - | - | - | - | 3,0 | 10 ad/pcs |



■ Yavaşlatıcı Alternatifi / Soft Closer Alternative

117-6666-1610 ►► 117-6710-1610 ►►



■ 103-7031

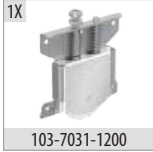

■ Ray Profilleri / Rail Profiles

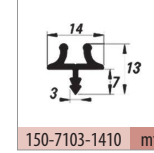
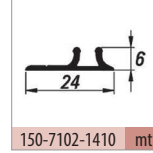
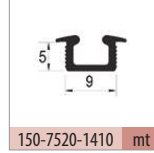
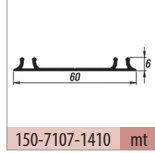
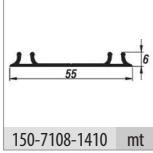

■ Kulp Profilleri / Handle Profiles

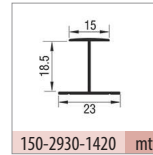
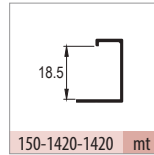
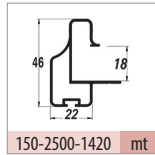
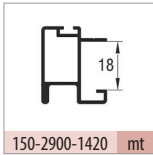

■ Opsiyonel Aksesuar / Optional Accessories



■ Teknik Detay / Technical Detail

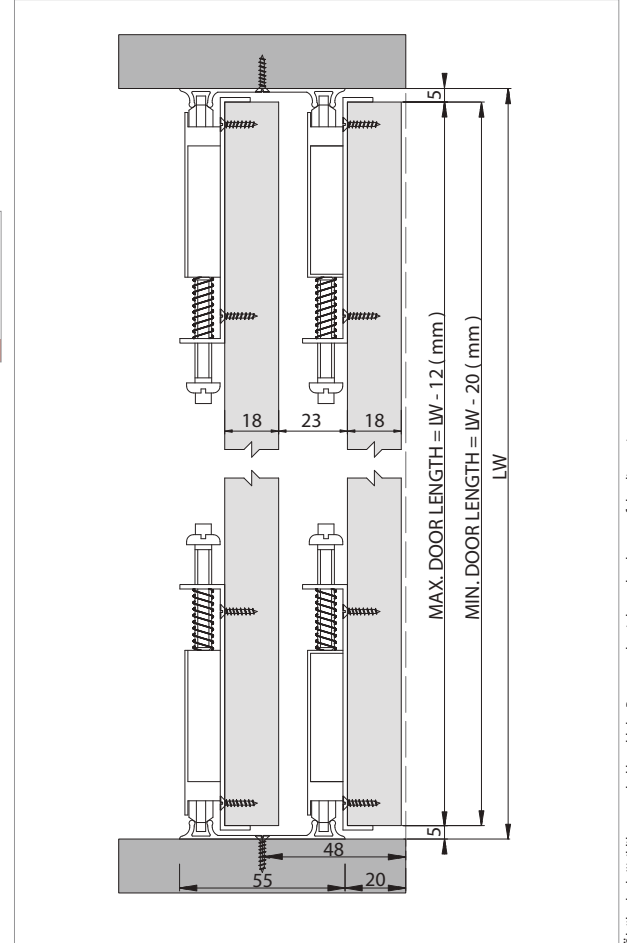

Ölçülerde değişiklik yapma hakkı saklıdır. Reserves the right to the change of the dimensions.

| Kod / Code No | Açıklama / Description | Renk / Colour | Birim / Unit | | | Profil mt. / Profiles mt. | | | Bağ / Bnd. |
|---------------|--|------------------------|----------------|-------|---------|---------------------------|-----|-----|------------|
| 103-7031-1200 | Sürme Kapak Sistemi / Sliding Door System | Silver | 1 Adet / 1 Pcs | 96 | 3.072 | - | - | - | - |
| 117-1010-1600 | Plastik Stoper / Plastic Stopper | Gri / Grey | 1 Adet / 1 Pcs | 1.056 | 126.000 | - | - | - | - |
| 117-1011-1600 | Plastik Ray Tapası / Plastic Rail Cap | Gri / Grey | 1 Adet / 1 Pcs | 1.000 | 120.000 | - | - | - | - |
| 150-7108-1410 | Alüminyum Alt-Üst Ray / Aluminium Bottom-Top Rail | Eloksal / Mat Anodized | mt. | - | - | 2,0 | 2,5 | 3,0 | 12 ad/pcs |
| 150-7107-1410 | Alüminyum Alt-Üst Ray / Aluminium Bottom-Top Rail | Eloksal / Mat Anodized | mt. | - | - | 2,0 | 2,5 | 3,0 | 12 ad/pcs |
| 150-7520-1410 | Alüminyum Alt-Üst Ray / Aluminium Bottom-Top Rail | Eloksal / Mat Anodized | mt. | - | - | - | - | 3,0 | 30 ad/pcs |
| 150-7102-1410 | Alüminyum Alt-Üst Ray / Aluminium Bottom-Top Rail | Eloksal / Mat Anodized | mt. | - | - | - | - | 3,0 | 20 ad/pcs |
| 150-7103-1410 | Alüminyum Alt-Üst Ray / Aluminium Bottom-Top Rail | Eloksal / Mat Anodized | mt. | - | - | - | - | 3,0 | 30 ad/pcs |
| 150-2900-1420 | Alüminyum Kulp Profili / Aluminium Handle Profile | Parlak / Bright | mt. | - | - | 2,0 | 2,5 | 3,0 | 6 ad/pcs |
| 150-2500-1420 | Alüminyum Kulp Profili / Aluminium Handle Profile | Parlak / Bright | mt. | - | - | 2,0 | - | 3,0 | 6 ad/pcs |
| 150-1420-1420 | Alüminyum Kapama Profili / Aluminium Closure Profile | Parlak / Bright | mt. | - | - | - | - | 3,0 | 10 ad/pcs |
| 150-2930-1420 | Alüminyum Orta Kayıt / Aluminium Horizontal Central | Parlak / Bright | mt. | - | - | - | - | 3,0 | 10 ad/pcs |



Bilgi / Information

- 1 Kutu İçeriği : 2 Kapak Mekanizma
- In 1 box : 2 Door Mechanism

Yavaşlatıcı Alternatifi / Soft Closer Alternative

- 117-6950-1610 <<>> 117-6970-1610 <<>> 117-6810-1600 <<>>
- 117-6940-1600 <<>> 117-6666-1610 >>> 117-6710-1610 >>>



103-7032 1 Takım İçeriği / 1 Kit Includes

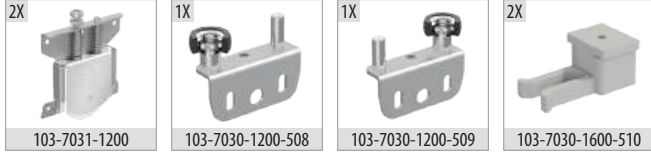

Ray Profilleri / Rail Profiles

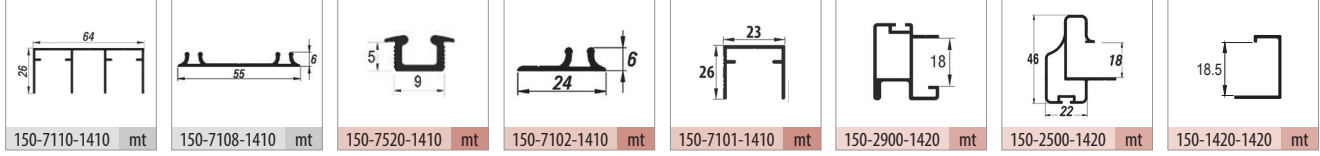

Kulp Profilleri / Handle Profiles

Teknik Detay / Technical Detail

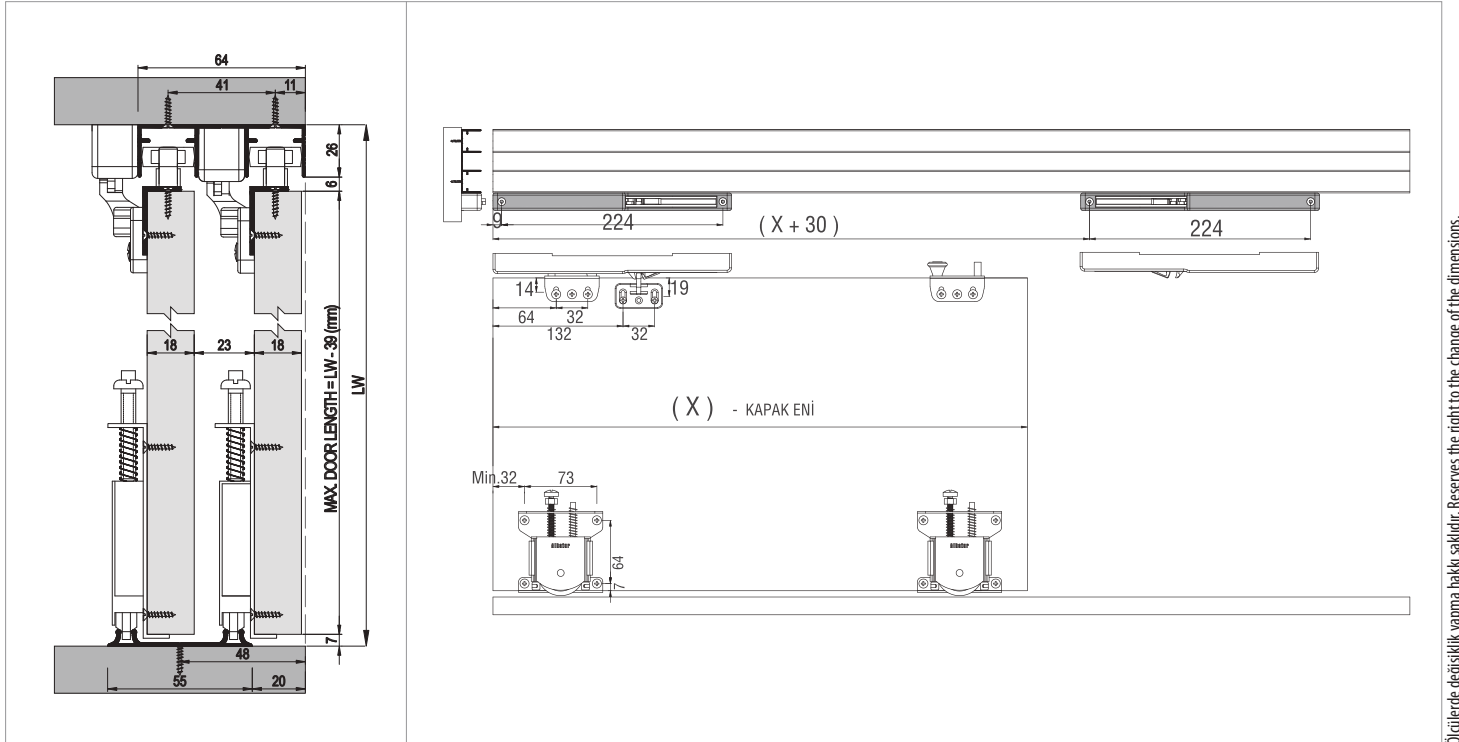

Ölçülerde değişiklik yapma hakkı saklıdır. Reserves the right to the change of the dimensions.

| Kod / Code No | Açıklama / Description | Renk / Colour | Birim / Unit | | | Profil mt. / Profiles mt. | Bağ / Bnd. |
|---------------|---|------------------------|-----------------|----|-------|---------------------------|------------|
| 103-7032-1200 | 7030 SFT -75 Kg Sürme Kapak Sistemi / 75 Kg Sliding Door System | Silver | 1 Kapak / 1 Kit | 32 | 1.024 | - - - | - |
| 150-7110-1410 | Alüminyum Üst Ray Profili / Aluminium Top Rail Profile | Eloksal / Mat Anodized | mt. | - | - | 2,0 2,5 3,0 | 6 ad/pcs |
| 150-7108-1410 | Alüminyum Alt Ray Profili / Aluminium Bottom Rail Profile | Eloksal / Mat Anodized | mt. | - | - | 2,0 2,5 3,0 | 12 ad/pcs |
| 150-2900-1420 | Alüminyum Kulp Profili / Aluminium Handle Profile | Parlak / Bright | mt. | - | - | 2,0 2,5 3,0 | 6 ad/pcs |
| 150-2500-1420 | Alüminyum Kulp Profili / Aluminium Handle Profile | Parlak / Bright | mt. | - | - | 2,0 - 3,0 | 6 ad/pcs |
| 150-1420-1420 | Alüminyum Kapama Profili / Aluminium Closure Profile | Parlak / Bright | mt. | - | - | - - 3,0 | 10 ad/pcs |

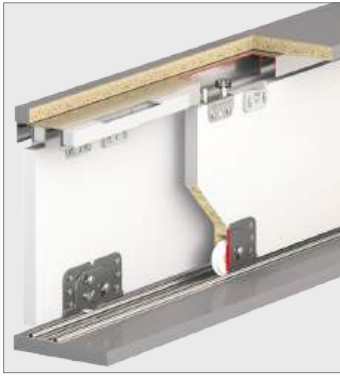

Bilgi / Information

- 1 Kutu İçeriği : 2 Kapak Mekanizma
- In 1 box : 2 Door Mechanism

Yavaşlatıcı Alternatifi / Soft Closer Alternative

- 117-6950-1610 <<>> 117-6970-1610 <<>> 117-6666-1610 >>>>
- 117-6710-1610 >>>> 117-6942-1610 <<>>



103-7012 1 Takım İçeriği / 1 Kit Includes

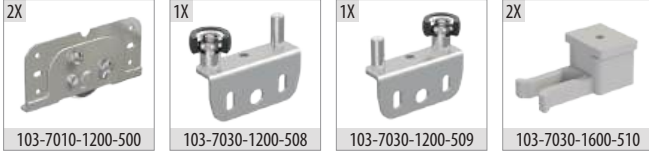

Ray Profilleri / Rail Profiles

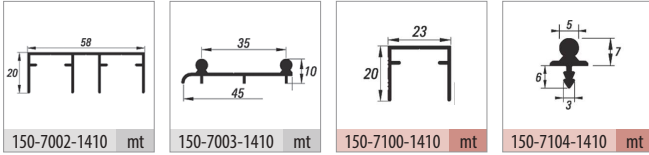

Kulp Profilleri / Handle Profiles

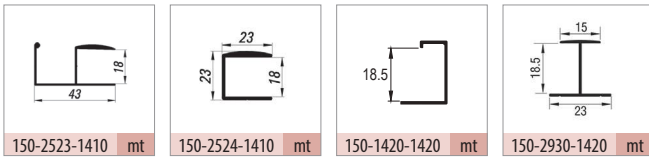

Uygulama / Application



Teknik Detay / Technical Detail

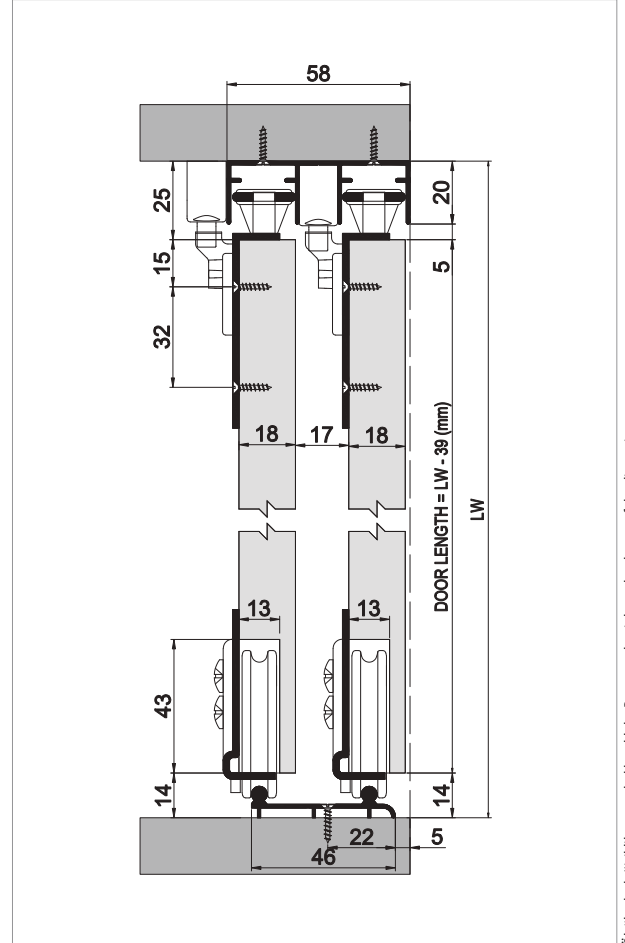

Ölçülerde değişiklik yapma hakkı saklıdır. Reserves the right to the change of the dimensions.

| Kod / Code No | Açıklama / Description | Renk / Colour | Birim / Unit | | | Profil mt. / Profiles mt. | Bağ / Bnd. |
|---------------|---|------------------------|-----------------|----|-------|---------------------------|------------|
| 103-7012-1200 | 80 Kg Sürme Kapak Sistemi / 80 Kg Sliding Door System | Silver | 1 Kapak / 1 Kit | 32 | 1.024 | - - - | - |
| 150-7002-1410 | Alüminyum Üst Ray Profili / Aluminium Top Rail Profile | Eloksal / Mat Anodized | mt. | - | - | 2,0 - 3,0 | 10 ad/pcs |
| 150-7003-1410 | Alüminyum Alt Ray Profili / Aluminium Bottom Rail Profile | Eloksal / Mat Anodized | mt. | - | - | 2,0 - 3,0 | 10 ad/pcs |
| 150-7100-1410 | Alüminyum Üst Ray Profili / Aluminium Top Rail Profile | Eloksal / Mat Anodized | mt. | - | - | - 3,0 | 12 ad/pcs |
| 150-7104-1410 | Alüminyum Alt Ray Profili / Aluminium Bottom Rail Profile | Eloksal / Mat Anodized | mt. | - | - | - 3,0 | 50 ad/pcs |
| 150-2523-1410 | Alüminyum Kulp Profili / Aluminium Handle Profile | Eloksal / Mat Anodized | mt. | - | - | 2,5 3,0 | 10 ad/pcs |
| 150-2524-1410 | Alüminyum Kapama Profili / Aluminium Closure Profile | Eloksal / Mat Anodized | mt. | - | - | - 2,5 3,0 | 10 ad/pcs |
| 150-1420-1420 | Alüminyum Kapama Profili / Aluminium Closure Profile | Parlak / Bright | mt. | - | - | - - 3,0 | 10 ad/pcs |
| 150-2930-1420 | Alüminyum Orta Kayıt / Aluminium Horizontal Central | Parlak / Bright | mt. | - | - | - - 3,0 | 10 ad/pcs |

Multiline 7010

80 KG SÜRME KAPAK SİSTEMİ • SLIDING DOOR SYSTEM



Bilgi / Information

- 1 Kutu İçeriği : 2 Kapak Mekanizma
- In 1 box : 2 Door Mechanism



Yavaşlatıcı Alternatifi / Soft Closer Alternative

- 117-6950-1610 <<>> 117-6970-1610 <<>> 117-6942-1610 <<>>
- 117-6940-1600 <<>> 117-6666-1610 >> 117-6710-1610 >>

103-7010 1 Takım İçeriği / 1 Kit Includes

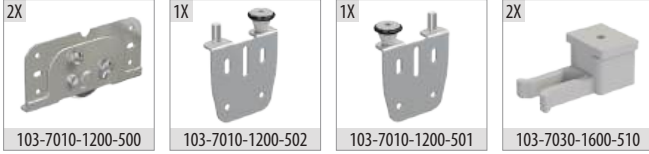

Ray Profilleri / Rail Profiles

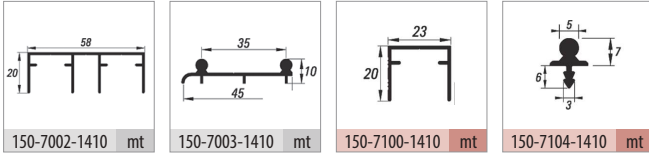

Kulp Profilleri / Handle Profiles

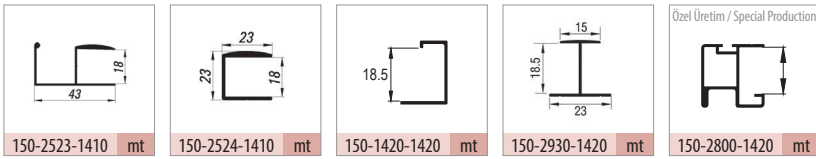

Uygulama / Application



Teknik Detay / Technical Detail

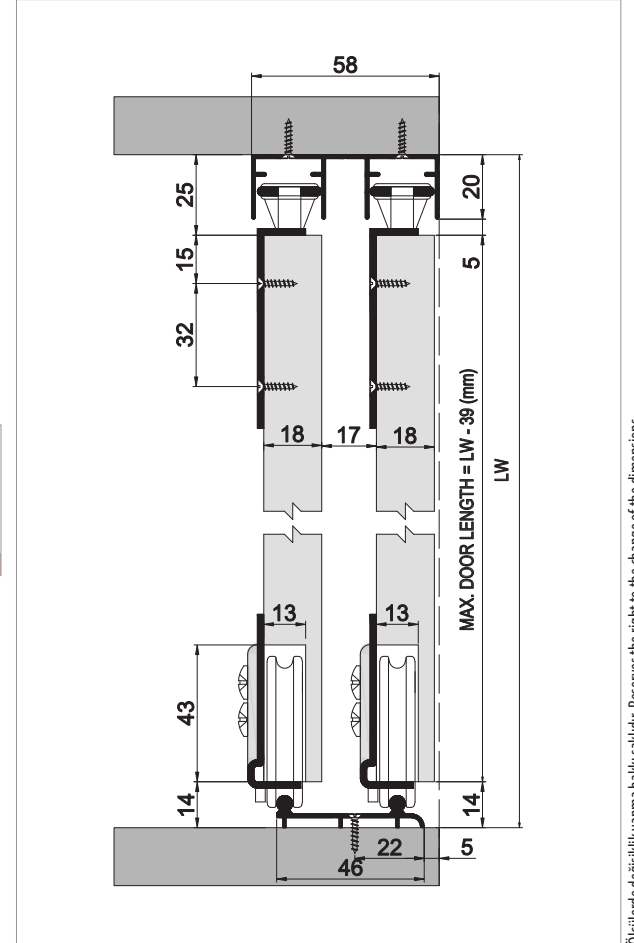

Ölçülerde değişiklik yapıma hakkı saklıdır. Reserves the right to the change of the dimensions.

| Kod / Code No | Açıklama / Description | Renk / Colour | Birim / Unit | | | Profil mt. / Profiles mt. | | | Bağ / Bnd. |
|---------------|---|------------------------|-----------------|----|-------|---------------------------|-----|-----|------------|
| 103-7010-1200 | 80 Kg Sürme Kapak Sistemi / 80 Kg Sliding Door System | Silver | 1 Kapak / 1 Kit | 32 | 1.024 | - | - | - | - |
| 150-7002-1410 | Alüminyum Üst Ray Profili / Aluminium Top Rail Profile | Eloksal / Mat Anodized | mt. | - | - | 2,0 | - | 3,0 | 10 ad/pcs |
| 150-7003-1410 | Alüminyum Alt Ray Profili / Aluminium Bottom Rail Profile | Eloksal / Mat Anodized | mt. | - | - | 2,0 | - | 3,0 | 10 ad/pcs |
| 150-7100-1410 | Alüminyum Üst Ray Profili / Aluminium Top Rail Profile | Eloksal / Mat Anodized | mt. | - | - | 2,0 | 2,5 | 3,0 | 12 ad/pcs |
| 150-7104-1410 | Alüminyum Alt Ray Profili / Aluminium Bottom Rail Profile | Eloksal / Mat Anodized | mt. | - | - | 2,0 | - | 3,0 | 50 ad/pcs |
| 150-2523-1410 | Alüminyum Kulp Profili / Aluminium Handle Profile | Eloksal / Mat Anodized | mt. | - | - | - | 2,5 | 3,0 | 10 ad/pcs |
| 150-2524-1410 | Alüminyum Kapama Profili / Aluminium Closure Profile | Eloksal / Mat Anodized | mt. | - | - | - | 2,5 | 3,0 | 10 ad/pcs |
| 150-1420-1420 | Alüminyum Kapama Profili / Aluminium Closure Profile | Parlak / Bright | mt. | - | - | - | - | 3,0 | 10 ad/pcs |
| 150-2930-1420 | Alüminyum Orta Kayıt / Aluminium Horizontal Central | Parlak / Bright | mt. | - | - | - | - | 3,0 | 10 ad/pcs |
| 150-2800-1420 | Alüminyum Kulp Profili / Aluminium Handle Profile | Parlak / Bright | mt. | - | - | - | - | 3,0 | 6 ad/pcs |



Bilgi / Information

- 1 Kutu İçeriği : 2 Kapak Mekanizma
- In 1 box : 2 Door Mechanism

Yavaşlatıcı Alternatifi / Soft Closer Alternative

- 117-6950-1610 <<>> 117-6970-1610 <<>> 117-6810-1600 <<>>
- 117-6940-1600 <<>> 117-6666-1610 >> 117-6710-1610 >>



103-7011 1 Takım İçeriği / 1 Kit Includes

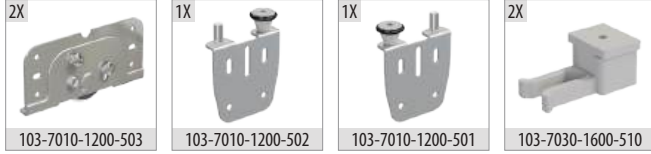

Ray Profilleri / Rail Profiles

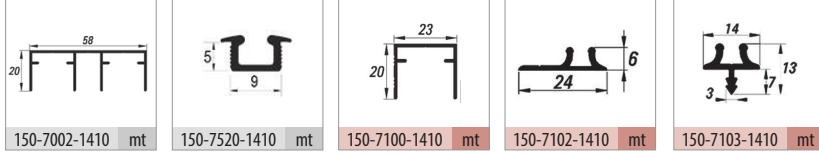

Kulp Profilleri / Handle Profiles

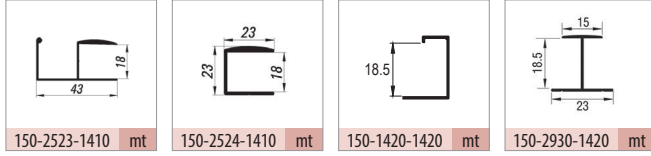

Opsiyonel Aksesuar / Optional Accessories



Teknik Detay / Technical Detail

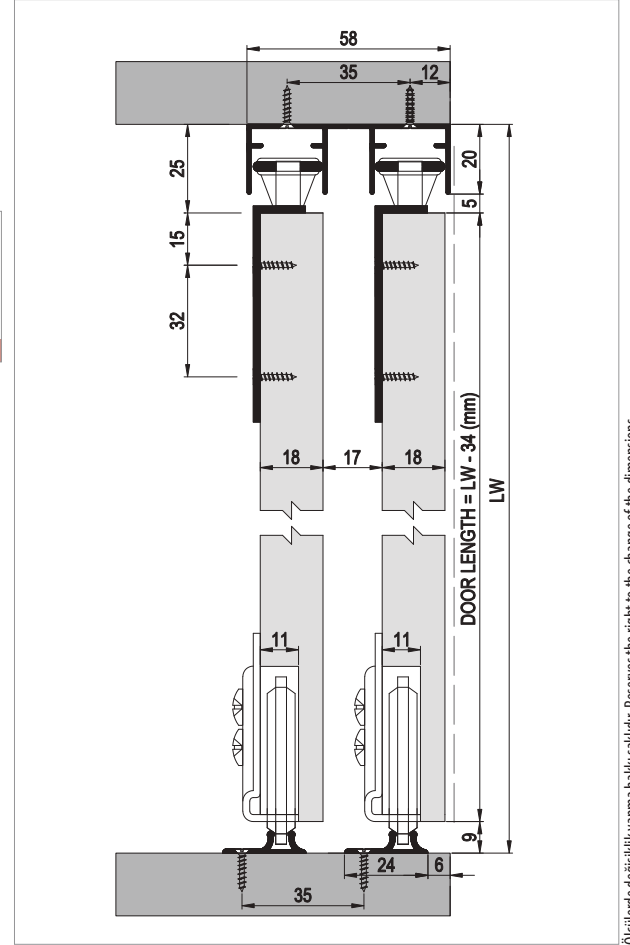

Ölçülerde değişiklik yapma hakkı saklıdır. Reserves the right to the change of the dimensions.

| Kod / Code No | Açıklama / Description | Renk / Colour | Birim / Unit | | | Profil mt. / Profiles mt. | Bağ / Bnd. |
|---------------|---|------------------------|-----------------|-------|---------|---------------------------|------------|
| 103-7011-1200 | 70 Kg Sürme Kapak Sistemi / 70 Kg Sliding Door System | Silver | 1 Kapak / 1 Kit | 32 | 1.024 | - - - | - |
| 117-1011-1600 | Plastik Ray Tapası / Plastic Rail Cap | Gri / Grey | 1 Adet / 1 Pcs | 1.000 | 120.000 | - - - | - |
| 150-7002-1410 | Alüminyum Üst Ray Profili / Aluminium Top Rail Profile | Eloksal / Mat Anodized | mt. | - | - | 2,0 - 3,0 | 10 ad/pcs |
| 150-7520-1410 | Alüminyum Alt Ray Profili / Aluminium Bottom Rail Profile | Eloksal / Mat Anodized | mt. | - | - | - 3,0 | 30 ad/pcs |
| 150-7100-1410 | Alüminyum Üst Ray Profili / Aluminium Top Rail Profile | Eloksal / Mat Anodized | mt. | - | - | - 3,0 | 12 ad/pcs |
| 150-7102-1410 | Alüminyum Alt Ray Profili / Aluminium Bottom Rail Profile | Eloksal / Mat Anodized | mt. | - | - | - 3,0 | 20 ad/pcs |
| 150-7103-1410 | Alüminyum Alt Ray Profili / Aluminium Bottom Rail Profile | Eloksal / Mat Anodized | mt. | - | - | - 3,0 | 30 ad/pcs |
| 150-2523-1410 | Alüminyum Kulp Profili / Aluminium Handle Profile | Eloksal / Mat Anodized | mt. | - | - | - 2,5 3,0 | 10 ad/pcs |
| 150-2524-1410 | Alüminyum Kapama Profili / Aluminium Closure Profile | Eloksal / Mat Anodized | mt. | - | - | - 2,5 3,0 | 10 ad/pcs |
| 150-1420-1420 | Alüminyum Kapama Profili / Aluminium Closure Profile | Parlak / Bright | mt. | - | - | - 3,0 | 10 ad/pcs |
| 150-2930-1420 | Alüminyum Orta Kayıt / Aluminium Horizontal Central | Parlak / Bright | mt. | - | - | - 3,0 | 10 ad/pcs |



Bilgi / Information

- 1 Kutu İçeriği : 2 Kapak Mekanizma
- In 1 box : 2 Door Mechanism

Yavaşlatıcı Alternatifi / Soft Closer Alternative

117-6666-1610 ►► 117-6710-1610 ►►



103-7020 1 Takım İçeriği / 1 Kit Includes

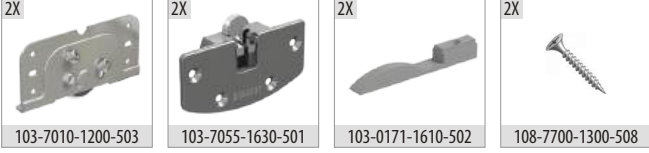

Ray Profilleri / Rail Profiles

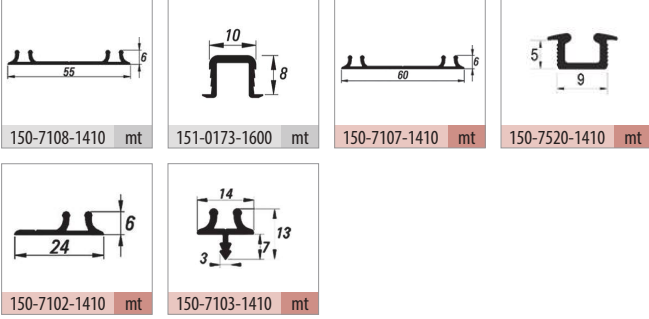

Kulp Profilleri / Handle Profiles

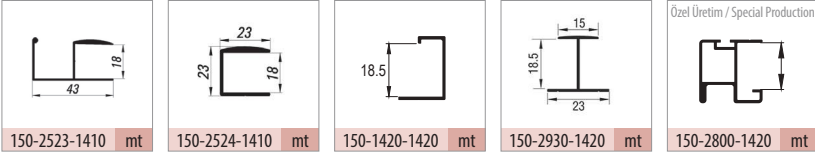

Opsiyonel Aksesuar / Optional Accessories



Teknik Detay / Technical Detail

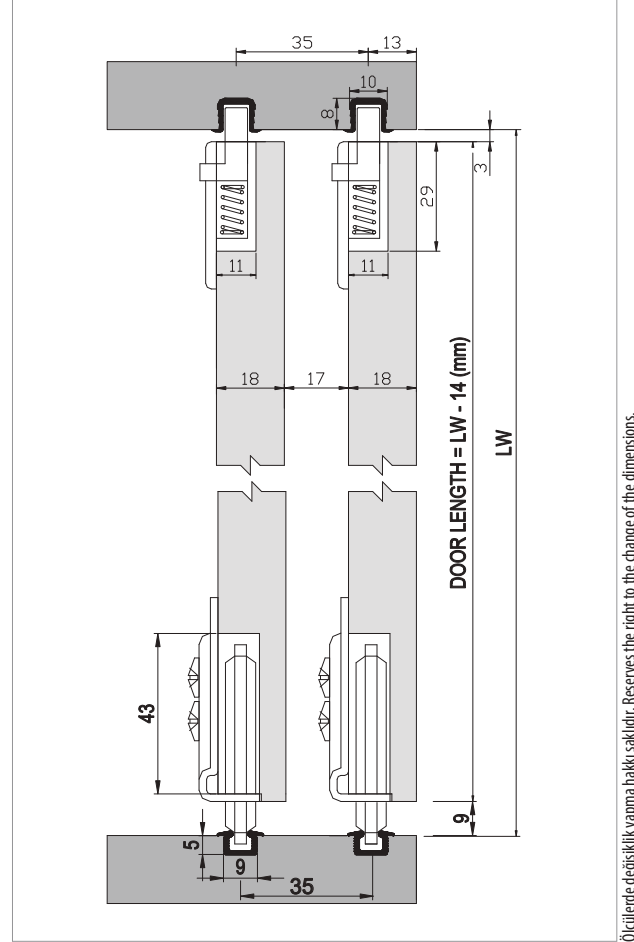

Ölçülerde değişiklik yapma hakkı saklıdır. Reserves the right to the change of the dimensions.

| Kod / Code No | Açıklama / Description | Renk / Colour | Birim / Unit | | | Profil mt. / Profiles mt. | Bağ / Bnd. |
|---------------|---|------------------------|-----------------|-------|---------|---------------------------|------------|
| 103-7020-1200 | 70 Kg Sürme Kapak Sistemi / 70 Kg Sliding Door System | Silver | 1 Kapak / 1 Kit | 32 | 1.024 | - - - | - |
| 117-1011-1600 | Plastik Ray Tapası / Plastic Rail Cap | Gri / Grey | 1 Adet / 1 Pcs | 1.000 | 120.000 | - - - | - |
| 151-0173-1600 | PVC Üst Ray Profili / PVC Top Rail Profile | Gri / Grey | mt. | - | - | - - 3,0 | 50 ad/pcs |
| 150-7108-1410 | Alüminyum Alt Ray Profili / Aluminium Bottom Rail Profile | Eloksal / Mat Anodized | mt. | - | - | 2,0 2,5 3,0 | 12 ad/pcs |
| 150-7107-1410 | Alüminyum Alt Ray Profili / Aluminium Bottom Rail Profile | Eloksal / Mat Anodized | mt. | - | - | 2,0 - 3,0 | 12 ad/pcs |
| 150-7520-1410 | Alüminyum Alt Ray Profili / Aluminium Bottom Rail Profile | Eloksal / Mat Anodized | mt. | - | - | - - 3,0 | 30 ad/pcs |
| 150-7102-1410 | Alüminyum Alt Ray Profili / Aluminium Bottom Rail Profile | Eloksal / Mat Anodized | mt. | - | - | - - 3,0 | 20 ad/pcs |
| 150-7103-1410 | Alüminyum Alt Ray Profili / Aluminium Bottom Rail Profile | Eloksal / Mat Anodized | mt. | - | - | - - 3,0 | 30 ad/pcs |
| 150-2523-1410 | Alüminyum Kulp Profili / Aluminium Handle Profile | Eloksal / Mat Anodized | mt. | - | - | - 2,5 3,0 | 10 ad/pcs |
| 150-2524-1410 | Alüminyum Kapama Profili / Aluminium Closure Profile | Eloksal / Mat Anodized | mt. | - | - | - 2,5 3,0 | 10 ad/pcs |
| 150-1420-1420 | Alüminyum Kapama Profili / Aluminium Closure Profile | Parlak / Bright | mt. | - | - | - - 3,0 | 10 ad/pcs |
| 150-2930-1420 | Alüminyum Orta Kayıt / Aluminium Horizontal Central | Parlak / Bright | mt. | - | - | - - 3,0 | 10 ad/pcs |



Bilgi / Information

- 1 Kutu İçeriği : 2 Kapak Mekanizma
- In 1 box : 2 Door Mechanism

Yavaşlatıcı Alternatifi / Soft Closer Alternative

117-6942-1610 ► 117-6666-1610 ► 117-6710-1610 ►



103-7060 1 Takım İçeriği / 1 Kit Includes

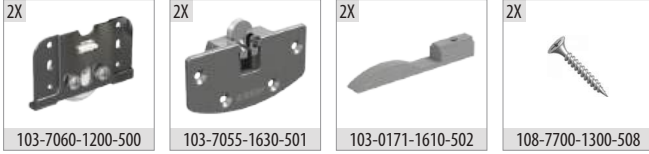

Ray Profilleri / Rail Profiles

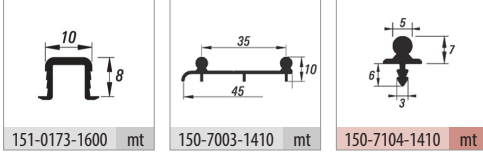

Kulp Profilleri / Handle Profiles

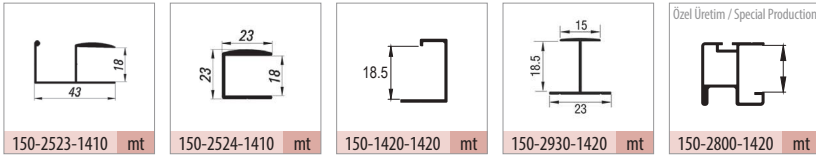

Teknik Detay / Technical Detail

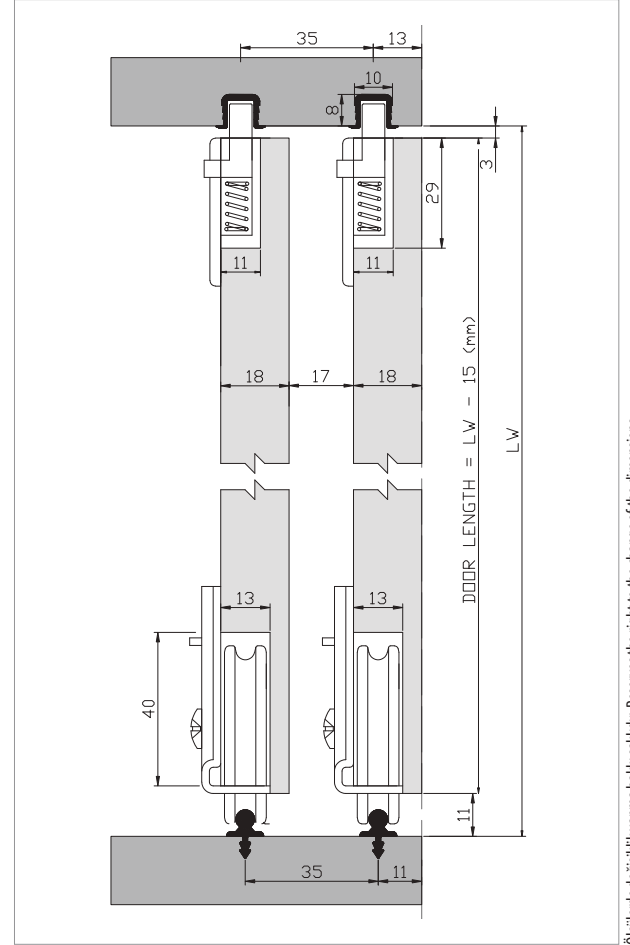

Ölçülerde değişiklik yapma hakkı saklıdır. Reserves the right to the change of the dimensions.

| Kod / Code No | Açıklama / Description | Renk / Colour | Birim / Unit | | | Profil mt. / Profiles mt. | Bağ / Bnd. |
|---------------|---|------------------------|-----------------|----|-------|---------------------------|------------|
| 103-7060-1200 | 60 Kg Sürme Kapak Sistemi / 60 Kg Sliding Door System | Silver | 1 Kapak / 1 Kit | 48 | 1.152 | - | - |
| 151-0173-1600 | PVC Üst Ray Profili / PVC Top Rail Profile | Gri / Grey | mt. | - | - | - | 3,0 |
| 150-7003-1410 | Alüminyum Alt Ray Profili / Aluminium Bottom Rail Profile | Eloksal / Mat Anodized | mt. | - | - | 2,0 | 3,0 |
| 150-7104-1410 | Alüminyum Alt Ray Profili / Aluminium Bottom Rail Profile | Eloksal / Mat Anodized | mt. | - | - | - | 3,0 |
| 150-2523-1410 | Alüminyum Kulp Profili / Aluminium Handle Profile | Eloksal / Mat Anodized | mt. | - | - | 2,5 | 3,0 |
| 150-2524-1410 | Alüminyum Kapama Profili / Aluminium Closure Profile | Eloksal / Mat Anodized | mt. | - | - | 2,5 | 3,0 |
| 150-1420-1420 | Alüminyum Kapama Profili / Aluminium Closure Profile | Parlak / Bright | mt. | - | - | - | 3,0 |
| 150-2930-1420 | Alüminyum Orta Kayıt / Aluminium Horizontal Central | Parlak / Bright | mt. | - | - | - | 3,0 |

Multiline 7055

60 KG SÜRME KAPAK SİSTEMİ • SLIDING DOOR SYSTEM

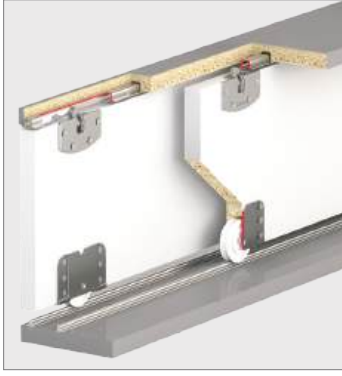

Bilgi / Information

- 1 Kutu İçeriği : 2 Kapak Mekanizma
- In 1 box : 2 Door Mechanism

Yavaşlatıcı Alternatifi / Soft Closer Alternative

117-6942-1610 ► 117-6666-1610 ► 117-6710-1610 ►



103-7055 1 Takım İçeriği / 1 Kit Includes

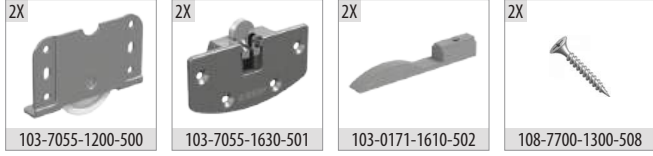

Ray Profilleri / Rail Profiles

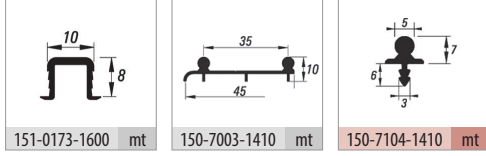

Kulp Profilleri / Handle Profiles

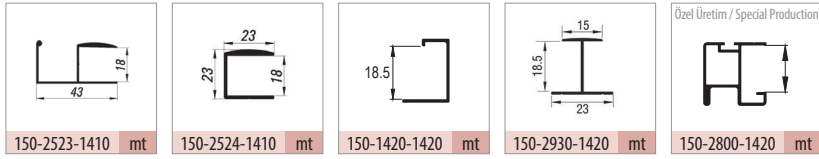

Teknik Detay / Technical Detail

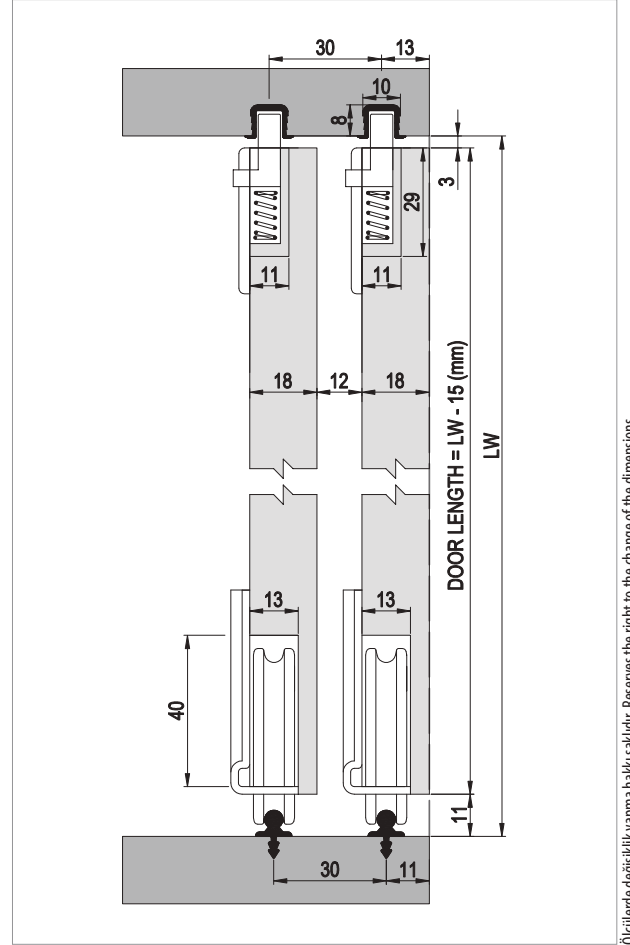

Ölçülerde değişiklik yapma hakkı saklıdır. Reserves the right to the change of the dimensions.

| Kod / Code No | Açıklama / Description | Renk / Colour | Birim / Unit | | | Profil mt. / Profiles mt. | Bağ / Bnd. |
|---------------|---|------------------------|-----------------|----|-------|---------------------------|------------|
| 103-7055-1200 | 60 Kg Sürme Kapak Sistemi / 60 Kg Sliding Door System | Silver | 1 Kapak / 1 Kit | 48 | 1.152 | - - - | - |
| 151-0173-1600 | PVC Üst Ray Profili / PVC Top Rail Profile Gri | Gri / Grey | mt. | - | - | - - 3,0 | 50 ad/pcs |
| 150-7003-1410 | Alüminyum Alt Ray Profili / Aluminium Bottom Rail Profile | Eloksal / Mat Anodized | mt. | - | - | 2,0 - 3,0 | 10 ad/pcs |
| 150-7104-1410 | Alüminyum Alt Ray Profili / Aluminium Bottom Rail Profile | Eloksal / Mat Anodized | mt. | - | - | - - 3,0 | 50 ad/pcs |
| 150-2523-1410 | Alüminyum Kulp Profili / Aluminium Handle Profile | Eloksal / Mat Anodized | mt. | - | - | - 2,5 3,0 | 10 ad/pcs |
| 150-2524-1410 | Alüminyum Kapama Profili / Aluminium Closure Profile | Eloksal / Mat Anodized | mt. | - | - | - 2,5 3,0 | 10 ad/pcs |
| 150-1420-1420 | Alüminyum Kapama Profili / Aluminium Closure Profile | Parlak / Bright | mt. | - | - | - - 3,0 | 10 ad/pcs |
| 150-2930-1420 | Alüminyum Orta Kayıt / Aluminium Horizontal Central | Parlak / Bright | mt. | - | - | - - 3,0 | 10 ad/pcs |

Multiline 6400

45 KG SÜRME KAPAK SİSTEMİ • SLIDING DOOR SYSTEM

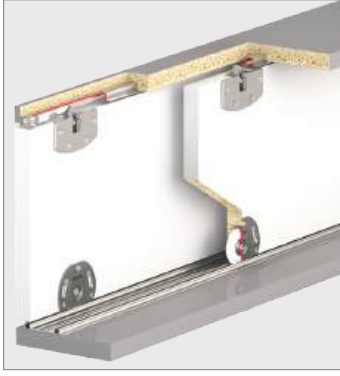

Bilgi / Information

- 1 Kutu İçeriği : 4 Kapak Mekanizma
- In 1 box : 4 Door Mechanism



Yavaşlatıcı Alternatifi / Soft Closer Alternative

117-6942-1610 ► 117-6666-1610 ► 117-6710-1610 ►

103-6400 1 Takım İçeriği / 1 Kit Includes

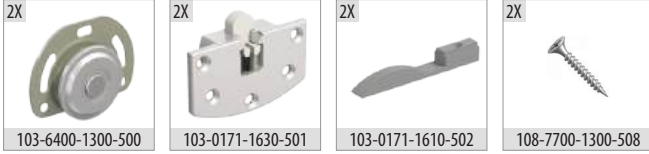

Ray Profilleri / Rail Profiles

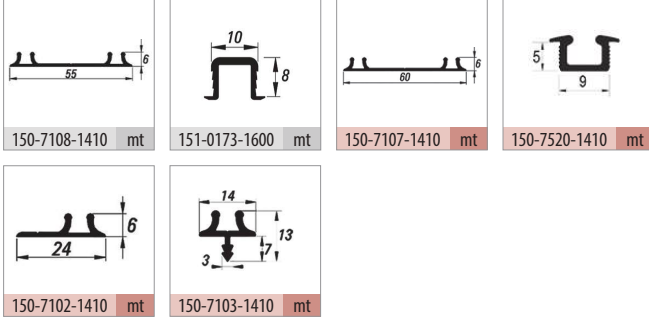

Kulp Profilleri / Handle Profiles

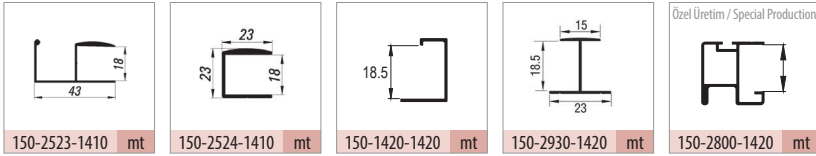

Opsiyonel Aksesuar / Optional Accessories



Teknik Detay / Technical Detail

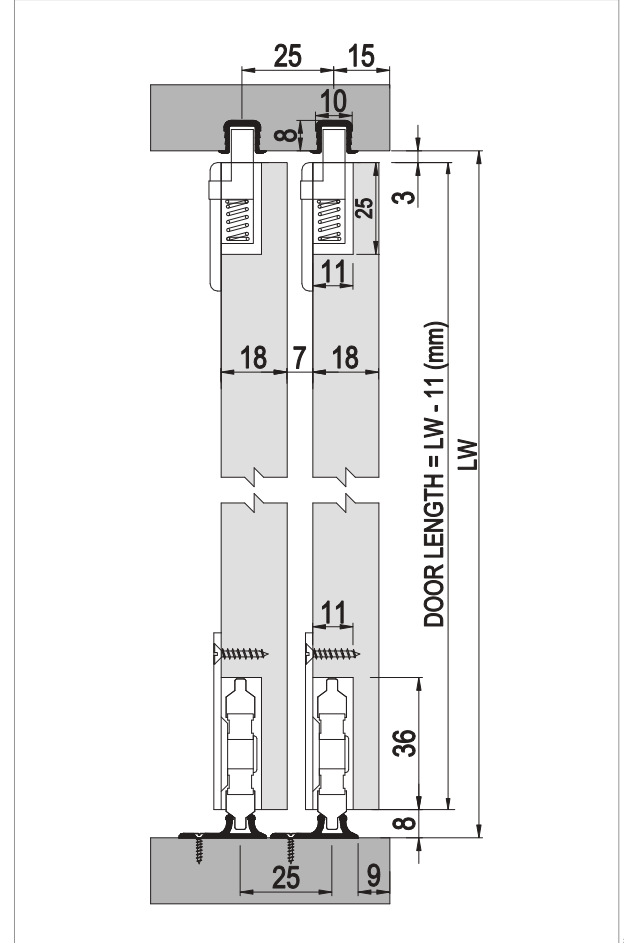

Ölçülerde değişiklik yapma hakkı saklıdır. Reserves the right to the change of the dimensions.

| Kod / Code No | Açıklama / Description | Renk / Colour | Birim / Unit | | | Profil mt. / Profiles mt. | | | Bağ / Bnd. |
|---------------|---|------------------------|-----------------|----|-------|---------------------------|-----|-----|------------|
| 103-6400-1300 | 45 Kg Sürme Kapak Sistemi / 45 Kg Sliding Door System | Galvaniz / Galvanized | 1 Kapak / 1 Kit | 96 | 2.304 | - | - | - | - |
| 150-7108-1410 | Alüminyum Alt Ray Profili / Aluminium Bottom Rail Profile | Eloksal / Mat Anodized | mt. | - | - | 2,0 | 2,5 | 3,0 | 12 ad/pcs |
| 151-0173-1600 | PVC Üst Ray Profili / PVC Top Rail Profile | Gri / Grey | mt. | - | - | - | - | 3,0 | 50 ad/pcs |
| 150-7107-1410 | Alüminyum Alt Ray Profili / Aluminium Bottom Rail Profile | Eloksal / Mat Anodized | mt. | - | - | 2,0 | - | 3,0 | 12 ad/pcs |
| 150-7520-1410 | Alüminyum Alt Ray Profili / Aluminium Bottom Rail Profile | Eloksal / Mat Anodized | mt. | - | - | - | - | 3,0 | 30 ad/pcs |
| 150-7102-1410 | Alüminyum Alt Ray Profili / Aluminium Bottom Rail Profile | Eloksal / Mat Anodized | mt. | - | - | - | - | 3,0 | 20 ad/pcs |
| 150-7103-1410 | Alüminyum Alt Ray Profili / Aluminium Bottom Rail Profile | Eloksal / Mat Anodized | mt. | - | - | - | - | 3,0 | 30 ad/pcs |
| 150-2523-1410 | Alüminyum Kulp Profili / Aluminium Handle Profile | Eloksal / Mat Anodized | mt. | - | - | - | 2,5 | 3,0 | 10 ad/pcs |
| 150-2524-1410 | Alüminyum Kapama Profili / Aluminium Closure Profile | Eloksal / Mat Anodized | mt. | - | - | - | 2,5 | 3,0 | 10 ad/pcs |
| 150-1420-1420 | Alüminyum Kapama Profili / Aluminium Closure Profile | Parlak / Bright | mt. | - | - | - | - | 3,0 | 10 ad/pcs |
| 150-2930-1420 | Alüminyum Orta Kayıt / Aluminium Horizontal Central | Parlak / Bright | mt. | - | - | - | - | 3,0 | 10 ad/pcs |

Multiline 7040

40 KG HAFİF SÜRME KAPAK SİSTEMİ • SLIDING LIGHT DUTY DOOR SYSTEM



■ Yavaşlatıcı Alternatifi / Soft Closer Alternative

117-6942-1610 ► 117-6666-1610 ► 117-6710-1610 ►



■ 103-7040 1 Takım İçeriği / 1 Kit Includes

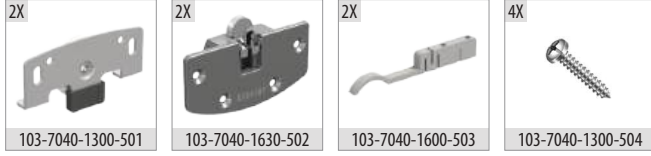

■ Ray Profilleri / Rail Profiles

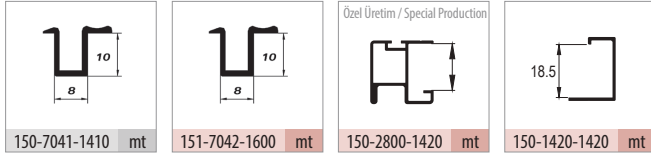

■ Kulp Profilleri / Handle Profiles

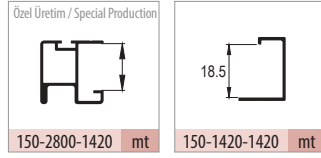

■ Teknik Detay / Technical Detail

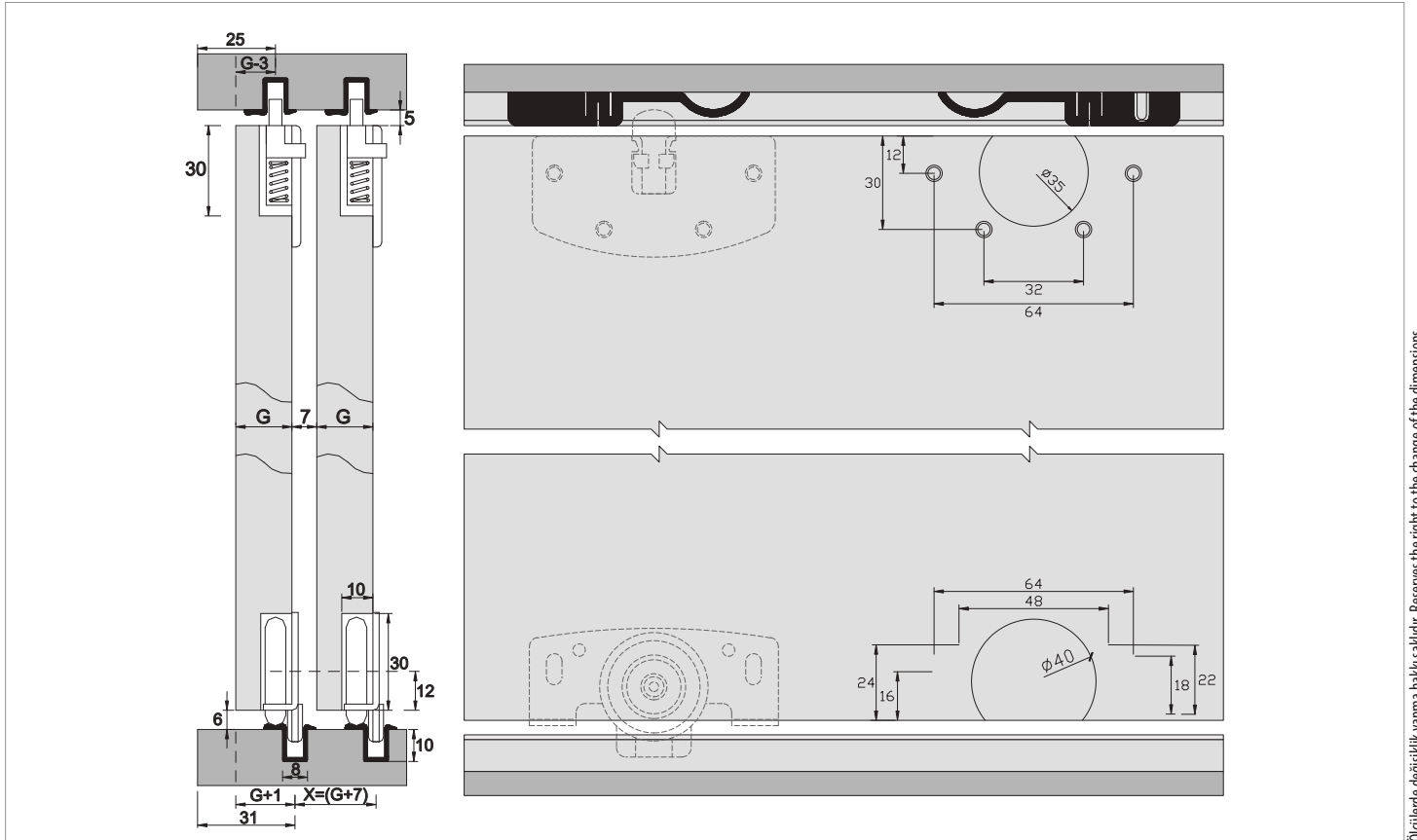

Ölçülerde değişiklik yapma hakkı saklıdır. Reserves the right to the change of the dimensions.

| Kod / Code No | Açıklama / Description | Renk / Colour | Birim / Unit | | | Profil mt. / Profiles mt. | Bağ / Bnd. |
|---------------|---|------------------------|-----------------|-----|-------|---------------------------|------------|
| 103-7040-1300 | 40 Kg Sürme Kapak Sistemi / 40 Kg Sliding Door System | Galvaniz / Galvanized | 1 Kapak / 1 Kit | 100 | 1.800 | - - - | - |
| 150-7041-1410 | Alüminyum Alt - Üst Ray Profili / Aluminium Top - Bottom Rail Profile | Eloksal / Mat Anodized | mt. | - | - | - - 3,0 | 50 ad/pcs |
| 151-7042-1600 | PVC Alt - Üst Ray Profili / PVC Top - Bottom Rail Profile | Gri / Grey | mt. | - | - | - - 3,0 | 50 ad/pcs |
| 150-2800-1420 | Alüminyum Kulp Profili / Aluminium Handle Profile | Parlak / Bright | mt. | - | - | - - 3,0 | 6 ad/pcs |
| 150-1420-1420 | Alüminyum Kapama Profili / Aluminium Closure Profile | Parlak / Bright | mt. | - | - | - - 3,0 | 10 ad/pcs |

Multiline 7045

45 KG HAFİF SÜRME KAPAK SİSTEMİ • SLIDING LIGHT DUTY DOOR SYSTEM



■ Yavaşlatıcı Alternatifi / Soft Closer Alternative

117-6942-1610 ► 117-6666-1610 ► 117-6710-1610 ►



■ 103-7045 1 Takım İçeriği / 1 Kit Includes

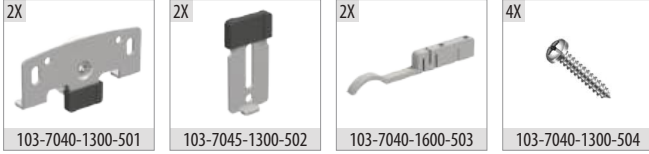

■ Ray Profilleri / Rail Profiles

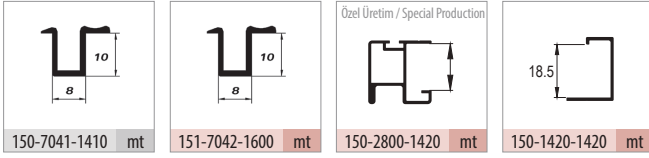

■ Kulp Profilleri / Handle Profiles

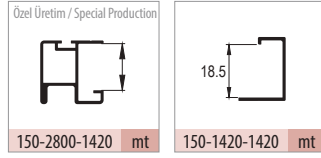

■ Teknik Detay / Technical Detail

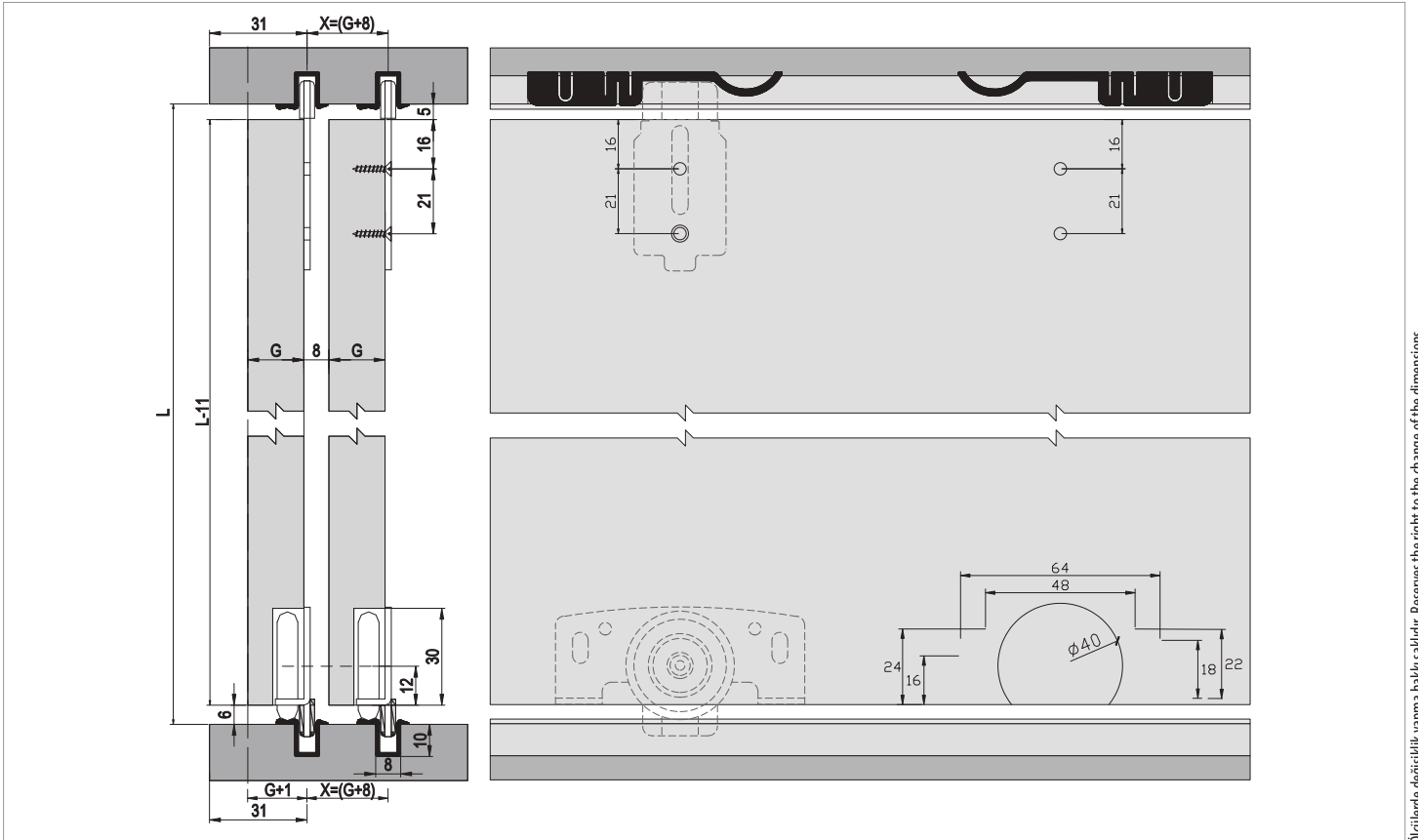

Ölçülerde değişiklik yapma hakkı saklıdır. Reserves the right to the change of the dimensions.

| Kod / Code No | Açıklama / Description | Renk / Colour | Birim / Unit | | | Profil mt. / Profiles mt. | Bağ / Bnd. |
|---------------|---|------------------------|-----------------|-----|-------|---------------------------|------------|
| 103-7045-1300 | 45 Kg Sürme Kapak Sistemi / 45 Kg Sliding Door System | Galvaniz / Galvanized | 1 Kapak / 1 Kit | 100 | 1.800 | - - - | - |
| 150-7041-1410 | Alüminyum Alt - Üst Ray Profili / Aluminium Top - Bottom Rail Profile | Eloksal / Mat Anodized | mt. | - | - | - - 3,0 | 50 ad/pcs |
| 151-7042-1600 | PVC Alt - Üst Ray Profili / PVC Top - Bottom Rail Profile | Gri / Grey | mt. | - | - | - - 3,0 | 50 ad/pcs |
| 150-2800-1420 | Alüminyum Kulp Profili / Aluminium Handle Profile | Parlak / Bright | mt. | - | - | - - 3,0 | 6 ad/pcs |
| 150-1420-1420 | Alüminyum Kapama Profili / Aluminium Closure Profile | Parlak / Bright | mt. | - | - | - - 3,0 | 10 ad/pcs |

Multiline 6500

15 KG HAFİF SÜRME KAPAK SİSTEMİ • SLIDING LIGHT DUTY DOOR SYSTEM



■ Yavaşlatıcı Alternatifi / Soft Closer Alternative

117-6942-1610 ►►



■ 103-6500 1 Takım İçeriği / 1 Kit Includes

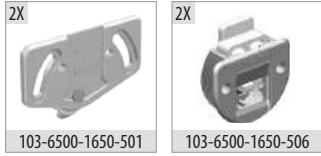

■ Ray Profilleri / Rail Profiles

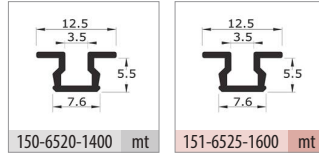

■ Kulp Profilleri / Handle Profiles

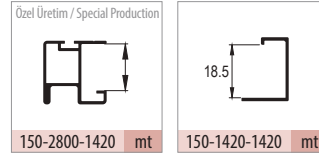

■ Teknik Detay / Technical Detail

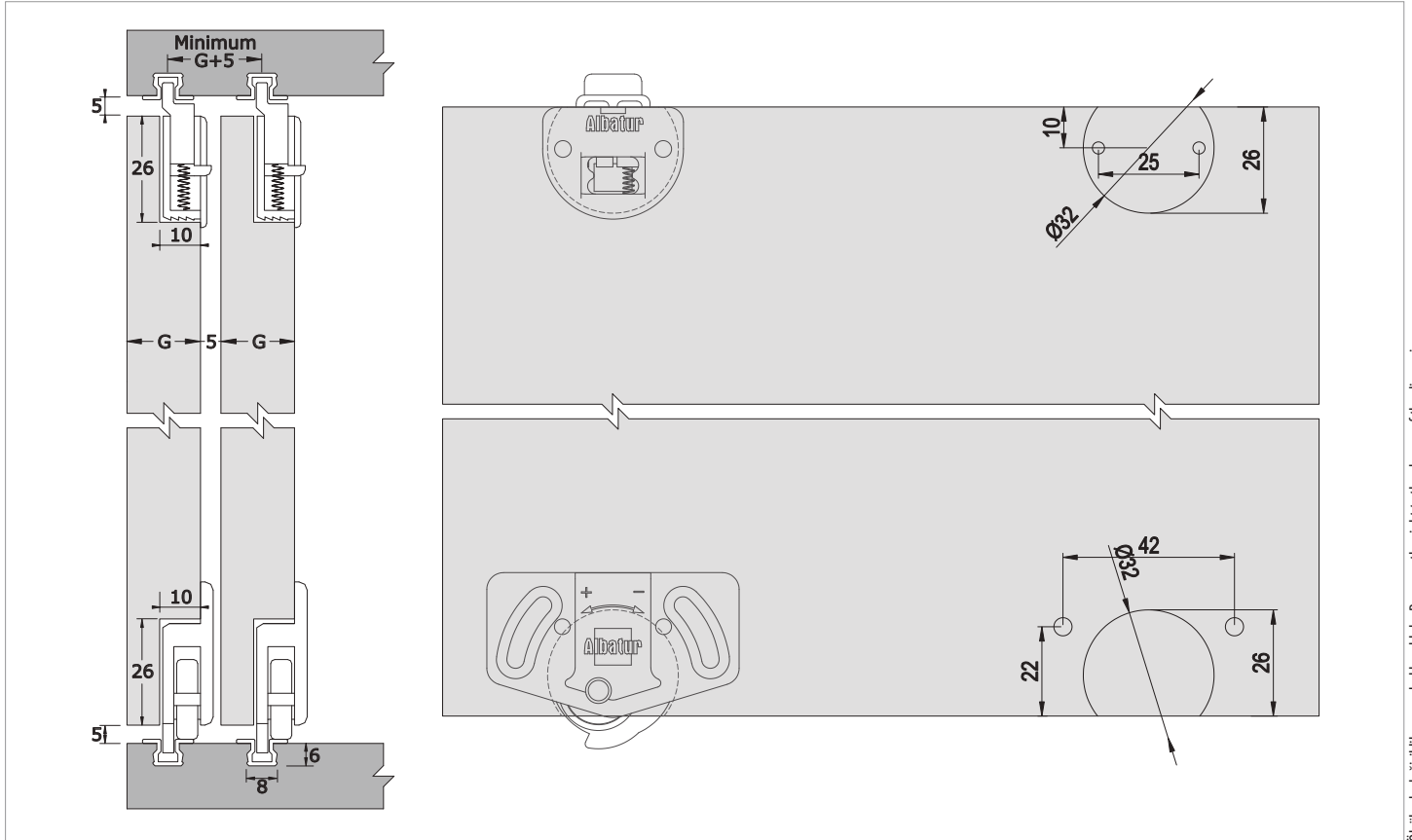

Ölçülerde değişiklik yapma hakkı saklıdır. Reserves the right to the change of the dimensions.

| Kod / Code No | Açıklama / Description | Renk / Colour | Birim / Unit | | | Profil mt. / Profiles mt. | Bağ / Bnd. |
|---------------|---|-----------------|-----------------|-----|-------|---------------------------|------------|
| 103-6500-1630 | 15 Kg Sürme Kapak Sistemi / 15 Kg Sliding Door System | Siyah / Black | 1 Kapak / 1 Kit | 100 | 3.200 | - - - | - |
| 103-6500-1680 | 15 Kg Sürme Kapak Sistemi / 15 Kg Sliding Door System | Meşe / Oak | 1 Kapak / 1 Kit | 100 | 3.200 | - - - | - |
| 103-6500-1670 | 15 Kg Sürme Kapak Sistemi / 15 Kg Sliding Door System | Kahve/Brown | 1 Kapak / 1 Kit | 100 | 3.200 | - - - | - |
| 103-6500-1650 | 15 Kg Sürme Kapak Sistemi / 15 Kg Sliding Door System | Beyaz / White | 1 Kapak / 1 Kit | 100 | 3.200 | - - - | - |
| 103-6500-1600 | 15 Kg Sürme Kapak Sistemi / 15 Kg Sliding Door System | Gri / Grey | 1 Kapak / 1 Kit | 100 | 3.200 | - - - | - |
| 150-6520-1400 | Alüminyum Ray Profili / Aluminium Rail Profile | Pres/ Uncoated | mt. | - | - | - - 3,0 | 30 ad/pcs |
| 151-6525-1600 | PVC Ray Profili / PVC Rail Profile | Gri / Grey | mt. | - | - | - - 3,0 | 30 ad/pcs |
| 150-2800-1420 | Alüminyum Kulp Profili / Aluminium Handle Profile | Parlak / Bright | mt. | - | - | - - 3,0 | 6 ad/pcs |
| 150-1420-1420 | Alüminyum Kapama Profili / Aluminium Closure Profile | Parlak / Bright | mt. | - | - | - - 3,0 | 10 ad/pcs |

Multiline 6510

15 KG HAFİF SÜRME KAPAK SİSTEMİ • SLIDING LIGHT DUTY DOOR SYSTEM



■ Yavaşlatıcı Alternatifi / Soft Closer Alternative

117-6942-1610 ►►



■ 103-6510 1 Takım İçeriği / 1 Kit Includes

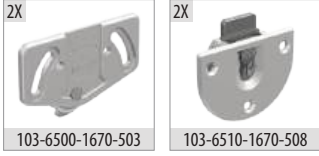

■ Ray Profilleri / Rail Profiles

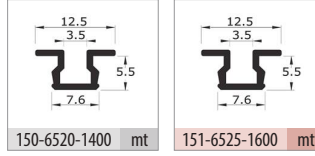

■ Kulp Profilleri / Handle Profiles

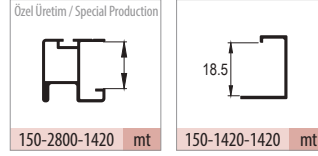

■ Teknik Detay / Technical Detail

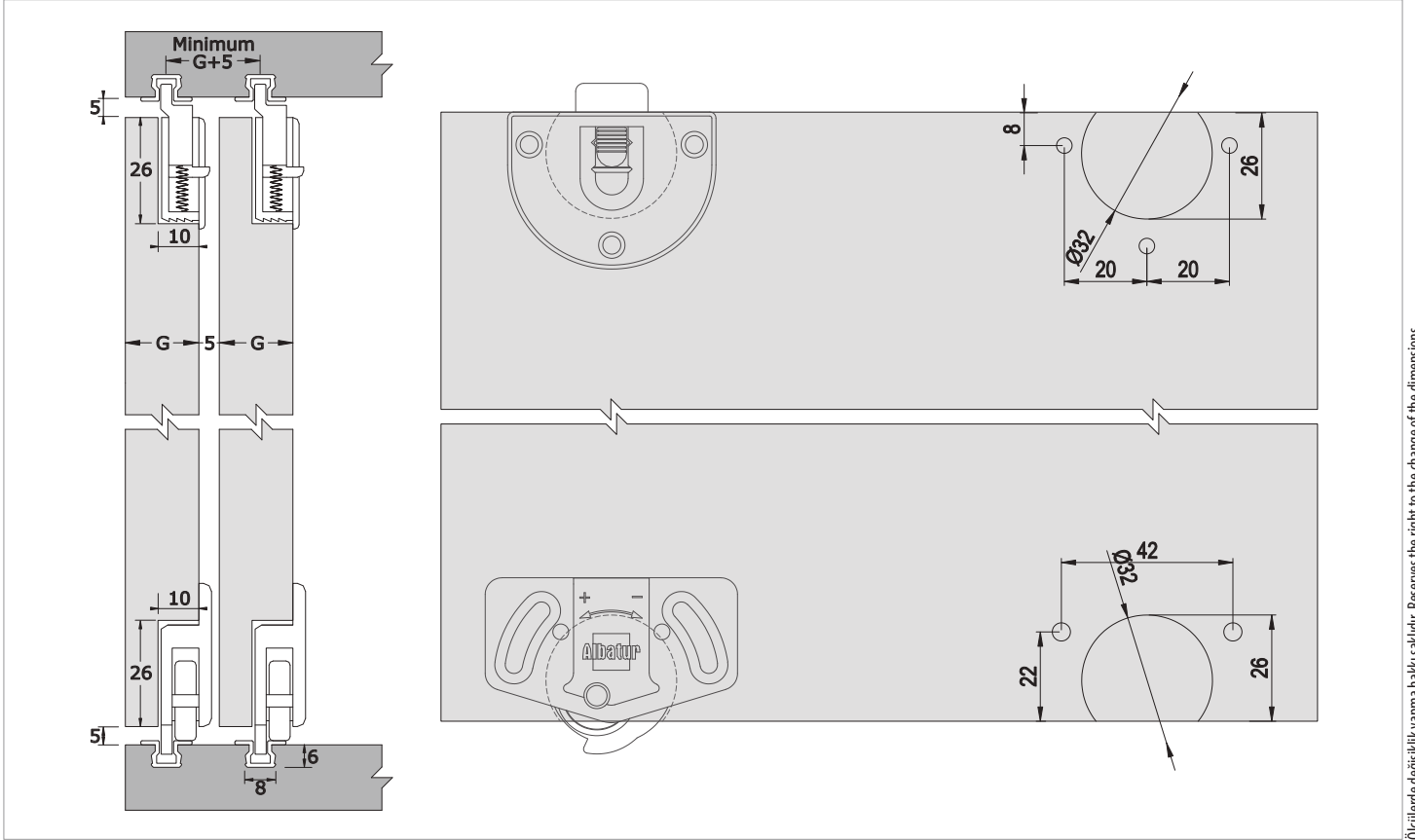

Ölçülerde değişiklik yapma hakkı saklıdır. Reserves the right to the change of the dimensions.

| Kod / Code No | Açıklama / Description | Renk / Colour | Birim / Unit | | | Profil mt. / Profiles mt. | | | Bağ / Bnd. |
|---------------|---|-----------------|-----------------|-----|-------|---------------------------|---|-----|------------|
| 103-6510-1670 | 15 Kg Sürme Kapak Sistemi / 15 Kg Sliding Door System | Kahve / Brown | 1 Kapak / 1 Kit | 100 | 3.200 | - | - | - | - |
| 150-6520-1400 | Alüminyum Ray Profili / Aluminium Rail Profile | Pres/ Uncoated | mt. | - | - | - | - | 3,0 | 30 ad/pcs |
| 151-6525-1600 | PVC Ray Profili / PVC Rail Profile | Gri / Grey | mt. | - | - | - | - | 3,0 | 30 ad/pcs |
| 150-2800-1420 | Alüminyum Kulp Profili / Aluminium Handle Profile | Parlak / Bright | mt. | - | - | - | - | 3,0 | 6 ad/pcs |
| 150-1420-1420 | Alüminyum Kapama Profili / Aluminium Closure Profile | Parlak / Bright | mt. | - | - | - | - | 3,0 | 10 ad/pcs |

Multiline 6000

40 KG SÜRME KAPAK SİSTEMİ • SLIDING DOOR SYSTEM



Bilgi / Information

- 1 Kutu İçeriği : 2 Kapak Mekanizma
- In 1 box : 2 Door Mechanism

Yavaşlatıcı Alternatifi / Soft Closer Alternative

117-6666-1610 ▶▶ 117-6710-1610 ▶▶



103-6000 1 Takım İçeriği / 1 Kit Includes

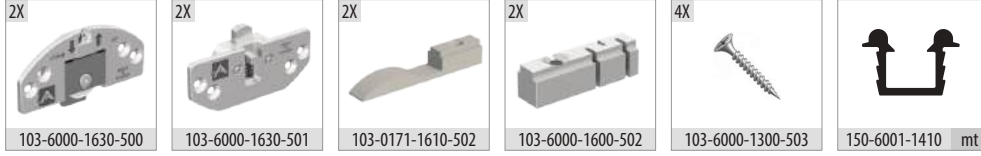

Ray Profilleri / Rail Profiles

Kulp Profilleri / Handle Profiles

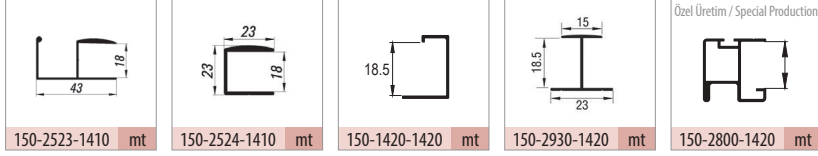

Teknik Detay / Technical Detail

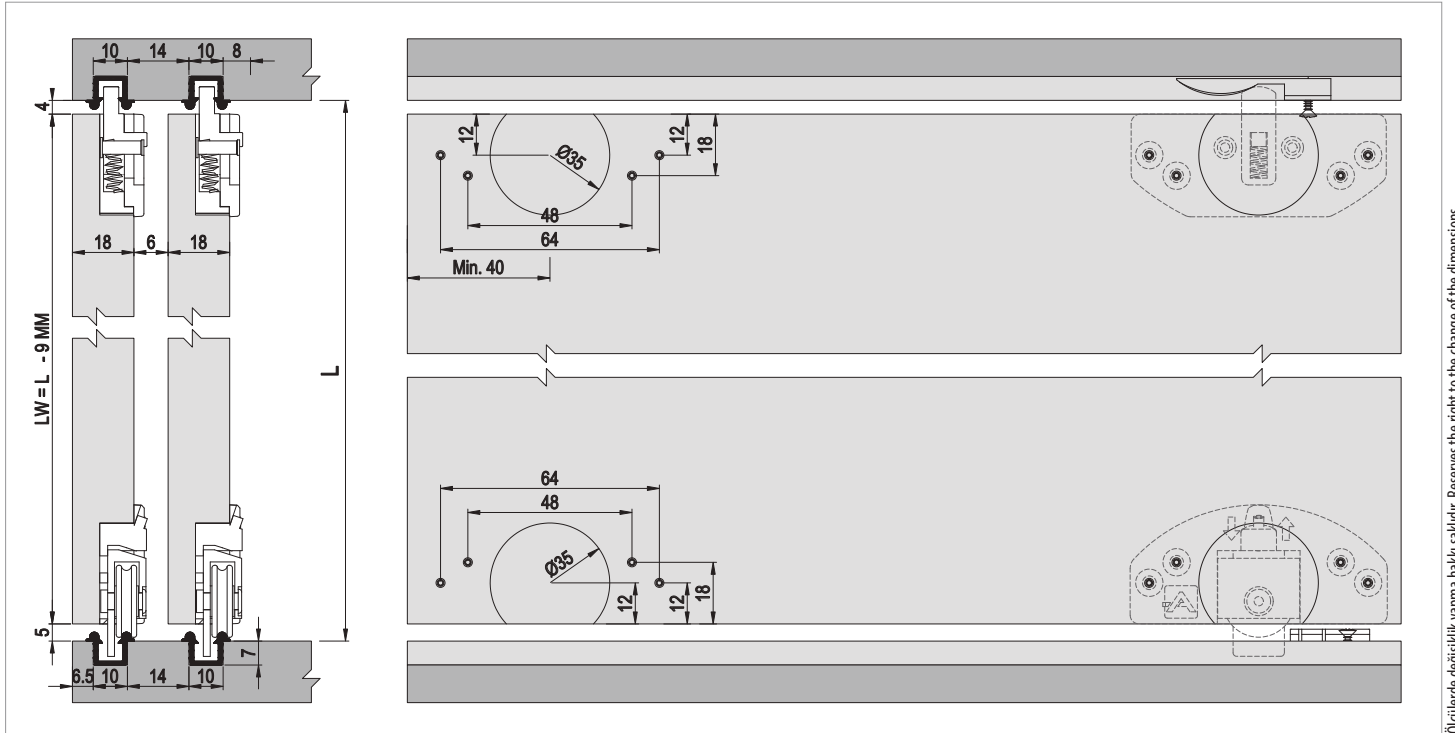

Ölçülerde değişiklik yapma hakkı saklıdır. Reserves the right to the change of the dimensions.

| Kod / Code No | Açıklama / Description | Renk / Colour | Birim / Unit | | | Profil mt. / Profiles mt. | | | Bağ / Bnd. |
|---------------|---|------------------------|-----------------|----|-------|---------------------------|-----|-----|------------|
| 103-6000-1630 | 40 Kg Sürme Kapak Sistemi / 40 Kg Sliding Door System | Siyah / Black | 1 Kapak / 1 Kit | 48 | 1.536 | - | - | - | - |
| 150-6001-1410 | Alüminyum Ray Profili / Aluminium Rail Profile | Eloksal / Mat Anodized | mt. | - | - | - | - | 3,0 | 30 ad/pcs |
| 150-2523-1410 | Alüminyum Kulp Profili / Aluminium Handle Profile | Eloksal / Mat Anodized | mt. | - | - | - | 2,5 | 3,0 | 10 ad/pcs |
| 150-2524-1410 | Alüminyum Kapama Profili / Aluminium Closure Profile | Eloksal / Mat Anodized | mt. | - | - | - | 2,5 | 3,0 | 10 ad/pcs |
| 150-1420-1420 | Alüminyum Kapama Profili / Aluminium Closure Profile | Parlak / Bright | mt. | - | - | - | - | 3,0 | 10 ad/pcs |
| 150-2930-1420 | Alüminyum Orta Kayıt / Aluminium Horizontal Central | Parlak / Bright | mt. | - | - | - | - | 3,0 | 10 ad/pcs |

Multiline 0171

30 KG SÜRME KAPAK SİSTEMİ • SLIDING DOOR SYSTEM



Bilgi / Information

- 1 Kutu İçeriği : 2 Kapak Mekanizma
- In 1 box : 2 Door Mechanism

Yavaşlatıcı Alternatifi / Soft Closer Alternative

117-6942-1610 ▶▶ 117-6666-1610 ▶▶ 117-6710-1610 ▶▶



103-0171 1 Takım İçeriği / 1 Kit Includes

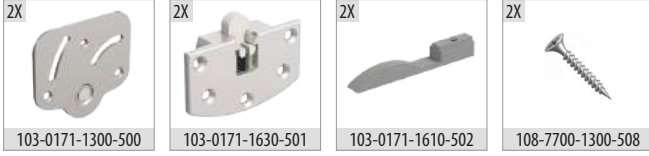

Ray Profilleri / Rail Profiles

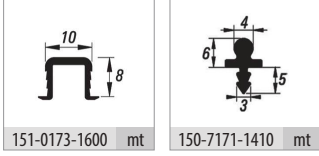

Kulp Profilleri / Handle Profiles

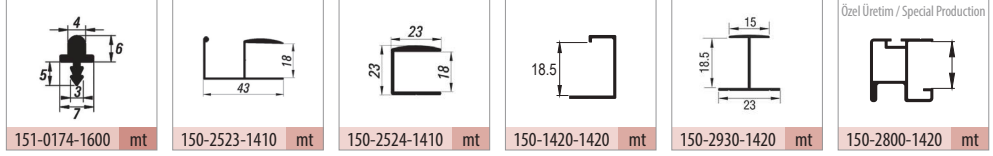

Teknik Detay / Technical Detail

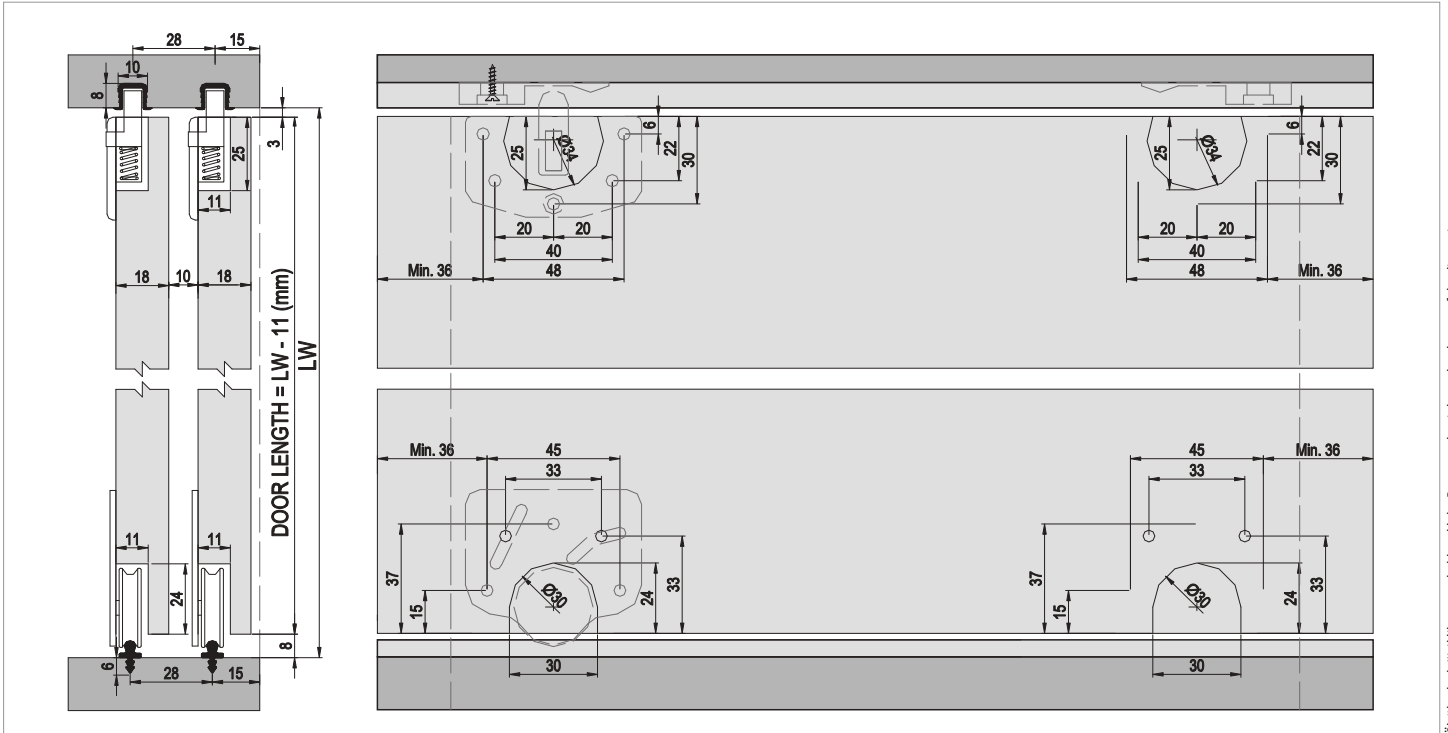

Ölçülerde değişiklik yapma hakkı saklıdır. Reserves the right to the change of the dimensions.

| Kod / Code No | Açıklama / Description | Renk / Colour | Birim / Unit | | | Profil mt. / Profiles mt. | Bağ / Bnd. |
|---------------|---|------------------------|-----------------|-----|-------|---------------------------|------------|
| 103-0171-1300 | 30 Kg Sürme Kapak Sistemi / 30 Kg Sliding Door System | Galvaniz / Galvanized | 1 Kapak / 1 Kit | 100 | 3.200 | - | - |
| 151-0173-1600 | PVC Ray Profili / PVC Rail Profile | Gri / Grey | mt. | - | - | - | 3,0 |
| 151-0174-1600 | PVC Ray Profili / PVC Rail Profile | Gri / Grey | mt. | - | - | - | 3,0 |
| 150-7171-1410 | Alüminyum Ray Profili / Aluminium Rail Profile | Eloksal / Mat Anodized | mt. | - | - | - | 3,0 |
| 150-2523-1410 | Alüminyum Kulp Profili / Aluminium Handle Profile | Eloksal / Mat Anodized | mt. | - | - | 2,5 | 3,0 |
| 150-2524-1410 | Alüminyum Kapama Profili / Aluminium Closure Profile | Eloksal / Mat Anodized | mt. | - | - | 2,5 | 3,0 |
| 150-1420-1420 | Alüminyum Kapama Profili / Aluminium Closure Profile | Parlak / Bright | mt. | - | - | - | 3,0 |
| 150-2930-1420 | Alüminyum Orta Kayıt / Aluminium Horizontal Central | Parlak / Bright | mt. | - | - | - | 3,0 |

Multiline 6600

25 KG SÜRME KAPAK SİSTEMİ • SLIDING DOOR SYSTEM

Özel Üretim
Special Production



Yavaşlatıcı Alternatifi / Soft Closer Alternative

117-6666-1610 ►► 117-6710-1610 ►►



103-6600 1 Takım İçeriği / 1 Kit Includes

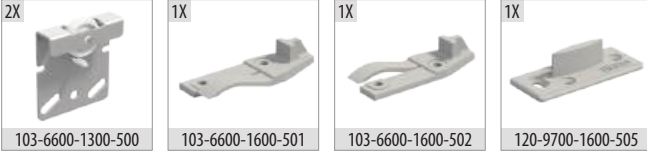

Ray Profilleri / Rail Profiles

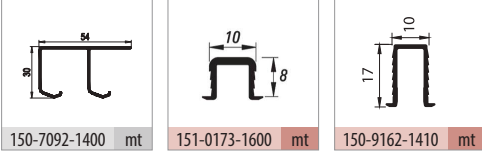

Teknik Detay / Technical Detail

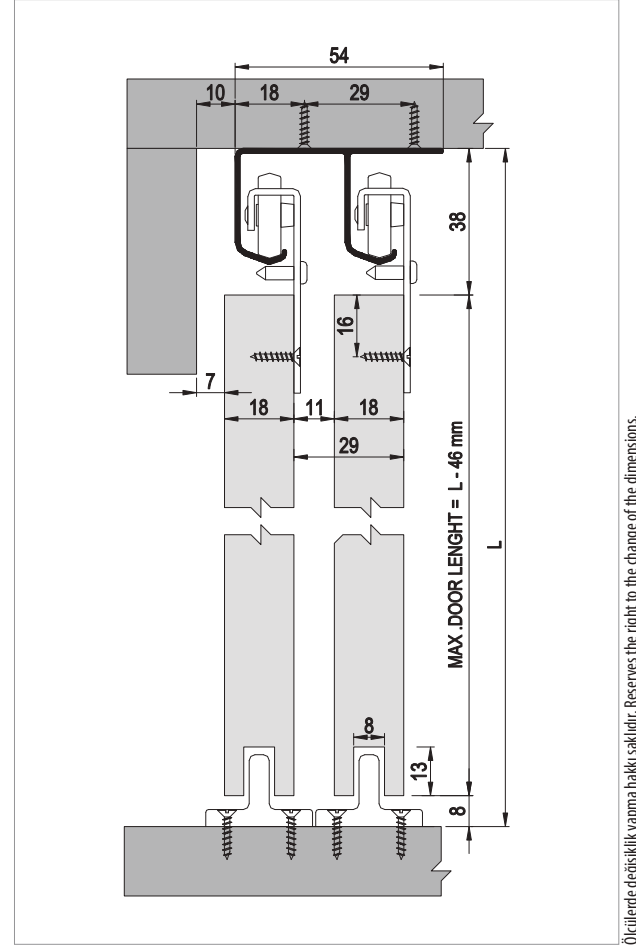

Ölçülerde değişiklik yapma hakkı saklıdır. Reserves the right to the change of the dimensions.

| Kod / Code No | Açıklama / Description | Renk / Colour | Birim / Unit | | | Profil mt. / Profiles mt. | | | Bağ / Bnd. |
|---------------|--|------------------------|-----------------|----|-----|---------------------------|---|-----|------------|
| 103-6600-1300 | 25 Kg Sürme Kapak Sistemi / 25 Kg Sliding Door System | Galvaniz / Galvanized | 1 Kapak / 1 Kit | 30 | 960 | - | - | - | - |
| 150-7092-1400 | Alüminyum Ray Profili / Aluminium Rail Profile | Pres / Uncoated | mt. | - | - | - | - | 3,0 | 24 ad/pcs |
| 151-0173-1600 | PVC Ray Profili / PVC Rail Profile | Gri / Grey | mt. | - | - | - | - | 3,0 | 50 ad/pcs |
| 150-9162-1410 | Alüminyum Alt Klavuz Profili / Aluminium Bottom Slider Profile | Eloksal / Mat Anodized | mt. | - | - | - | - | 3,0 | 20 ad/pcs |

Multiline 6320

19 KG SÜRME KAPAK SİSTEMİ • SLIDING DOOR SYSTEM



■ Yavaşlatıcı Alternatifi / Soft Closer Alternative

117-6940-1600 <<>> 117-6942-1610 <<>>



■ 103-6320 1 Takım İçeriği / 1 Kit Includes

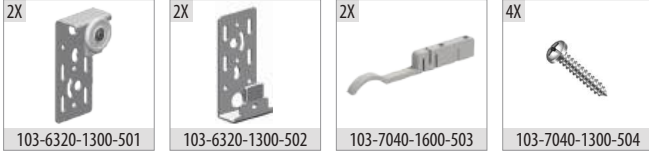

■ Ray Profilleri / Rail Profiles

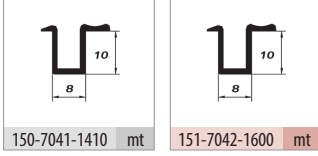

■ Kulp Profilleri / Handle Profiles

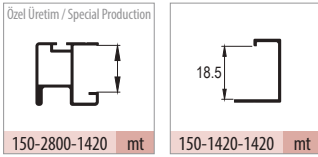

■ Uygulama / Application



■ Teknik Detay / Technical Detail

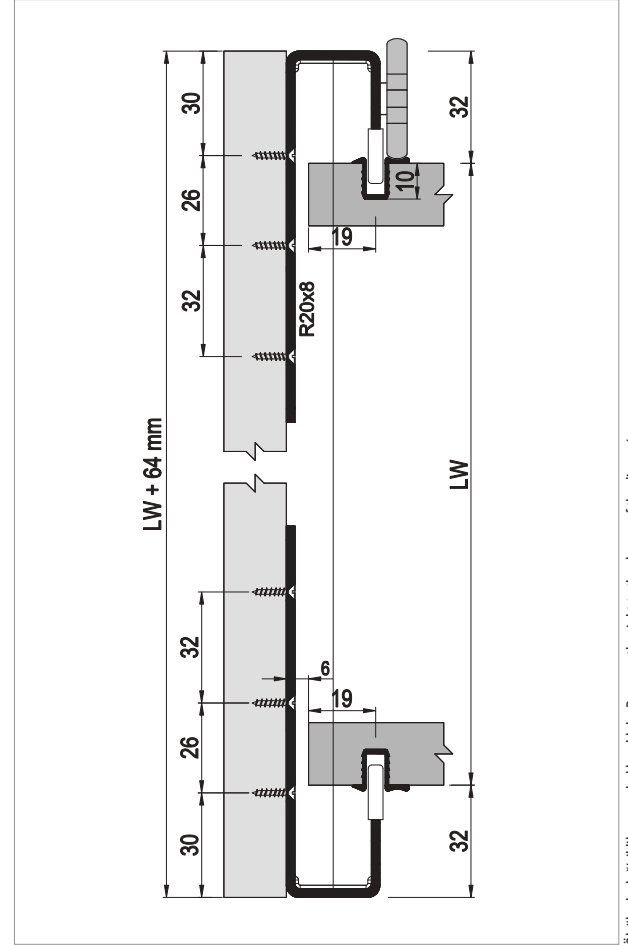

Ölçülerde değişiklik yapma hakkı saklıdır. Reserves the right to the change of the dimensions.

| Kod / Code No | Açıklama / Description | Renk / Colour | Birim / Unit | | | Profil mt. / Profiles mt. | Bağ / Bnd. |
|---------------|---|------------------------|-----------------|----|-----|---------------------------|------------|
| 103-6320-1300 | 19 Kg Sürme Kapak Sistemi / 19 Kg Sliding Door System | Galvaniz / Galvanized | 1 Kapak / 1 Kit | 24 | 576 | - - - | - |
| 150-7041-1410 | Alüminyum Alt Ray Profili / Aluminium Bottom Rail Profile | Eloksal / Mat Anodized | mt. | - | - | - - 3,0 | 50 ad/pcs |
| 151-7042-1600 | PVC Üst Ray Profili / PVC Top Rail Profile | Gri / Grey | mt. | - | - | - - 3,0 | 50 ad/pcs |
| 150-1420-1420 | Alüminyum Kapama Profili / Aluminium Closure Profile | Parlak / Bright | mt. | - | - | - - 3,0 | 10 ad/pcs |



103-6100 1 Takım İçeriği / 1 Kit Includes

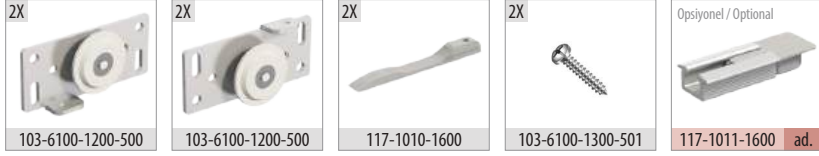

103-6120 1 Takım İçeriği / 1 Kit Includes



Ray Profilleri / Rail Profiles

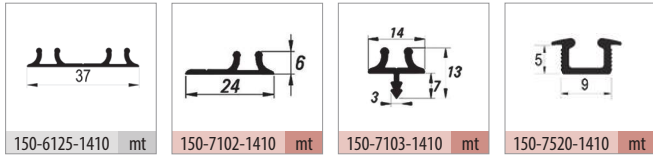

Uygulama / Application



Teknik Detay / Technical Detail

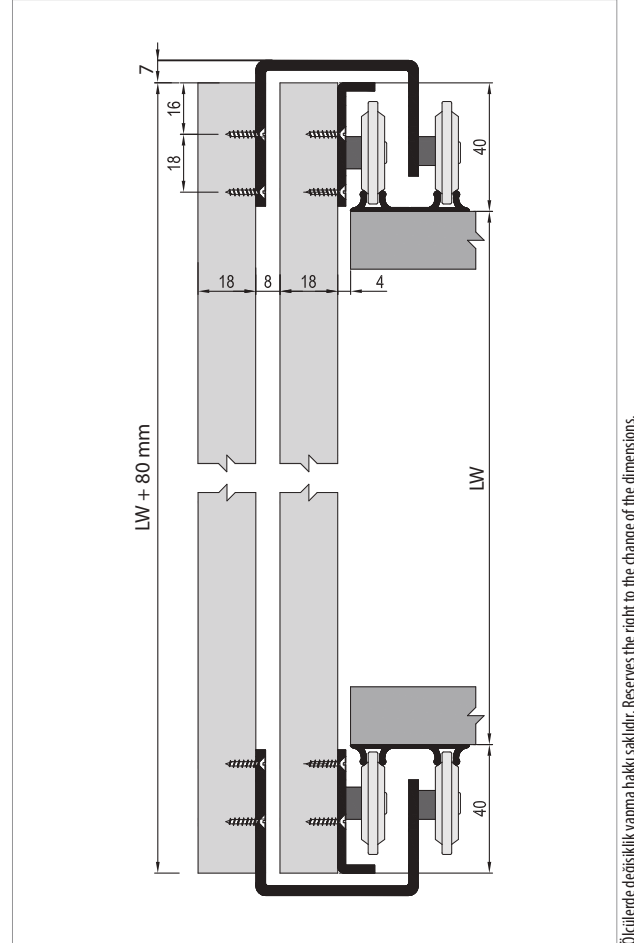

Ölçülerde değişiklik yapma hakkı saklıdır. Reserves the right to the change of the dimensions.

| Kod / Code No | Açıklama / Description | Renk / Colour | Birim / Unit | | | Profil mt. / Profiles mt. | Bağ / Bnd. |
|---------------|---|------------------------|-----------------|-----|------|---------------------------|------------|
| 103-6100-1200 | 30 Kg Sürme Kapak Sistemi İç Kapak / 30 Kg Sliding Door System Internal Door | Galvaniz / Galvanized | 1 Kapak / 1 Kit | 100 | 3200 | - - - | - |
| 103-6120-1200 | 30 Kg Sürme Kapak Sistemi Dış Kapak / 30 Kg Sliding Door System External Door | Galvaniz / Galvanized | 1 Kapak / 1 Kit | 24 | 576 | - - - | - |
| 150-6125-1410 | Alüminyum Ray Profili / Aluminium Rail Profile | Eloksal / Mat Anodized | mt. | - | - | - - 3,0 | 24 ad/pcs |
| 150-7520-1410 | Alüminyum Ray Profili / Aluminium Rail Profile | Eloksal / Mat Anodized | mt. | - | - | - - 3,0 | 30 ad/pcs |
| 150-7102-1410 | Alüminyum Ray Profili / Aluminium Rail Profile | Eloksal / Mat Anodized | mt. | - | - | - - 3,0 | 20 ad/pcs |
| 150-7103-1410 | Alüminyum Ray Profili / Aluminium Rail Profile | Eloksal / Mat Anodized | mt. | - | - | - - 3,0 | 30 ad/pcs |

Multiline 7601

15 KG SÜRME KAPAK SİSTEMİ • SLIDING DOOR SYSTEM

7600 PK

Özel Üretim
Special Production



Yavaşlatıcı Alternatifi / Soft Closer Alternative

117-6940-1600 <<>> 117-6942-1610 <<>>



103-7601 1 Takım İçeriği / 1 Kit Includes



Ray Profilleri / Rail Profiles

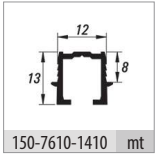

Uygulama / Application



Teknik Detay / Technical Detail

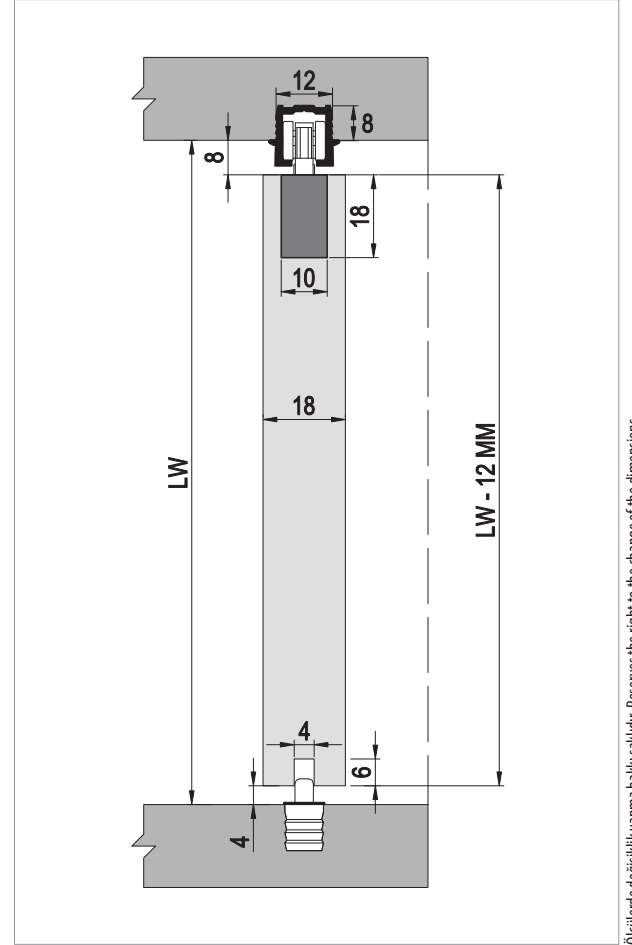

Ölçülerde değişiklik yapma hakkı saklıdır. Reserves the right to the change of the dimensions.

| Kod / Code No | Açıklama / Description | Renk / Colour | Birim / Unit | | | Profil mt. / Profiles mt. | Bağ / Bnd. |
|---------------|--|------------------------|-----------------|----|-------|---------------------------|------------|
| 103-7601-1600 | 15 Kg Sürme Kapak Sistemi / 15 Kg Sliding Door System | Gri / Grey | 1 Kapak / 1 Kit | 20 | 2.400 | - - - | - |
| 150-7610-1410 | Alüminyum Üst Ray Profili / Aluminium Top Rail Profile | Eloksal / Mat Anodized | mt. | - | - | - - 3,0 | 10 ad/pcs |

Group 105

WingSlide®

Sürme Katlanır Kapak Serisi
Sliding Foldable Door Series



Bu serideki tüm ürünleri incelemek için QR kodu okutabilirsiniz.

You can search the QR code to see all the products in these series.



WingSlide **7400**



WingSlide **7405**



WingSlide **7410**



WingSlide **7420**



WingSlide **7430**



WingSlide **7440**



WingSlide **7441**

WingSlide 7400

25 KG KATLANIR SÜRME GARDIROP SİSTEMİ • SLIDING SYSTEM FOR FOLDING DOORS



Bilgi / Information

- Maksimum kapak yüksekliği 240 cm önerilir.
- Maksimum 25 kg / 1 kapak
- Maksimum kapak eni 60 cm önerilir.
- Max. height of 240 cm
- Maximum 25 kg / 1 door
- Maximum width 60 cm

Yavaşlatıcı Alternatifi / Soft Closer Alternative

- Katlanır kapak sistemlerinde yavaşlatıcı için, yavaşlatıcı menteşe tercih edebilirsiniz.
- For foldable door systems with soft closing, you can prefer soft closing hinge.



105-7400 1 Takım İçeriği / 1 Kit Includes

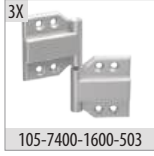

Ray Profilleri / Rail Profiles

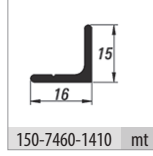
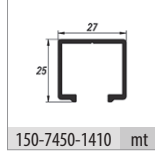

Opsiyonel / Optional

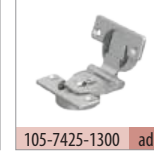
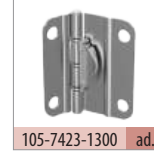

Teknik Detay / Technical Detail

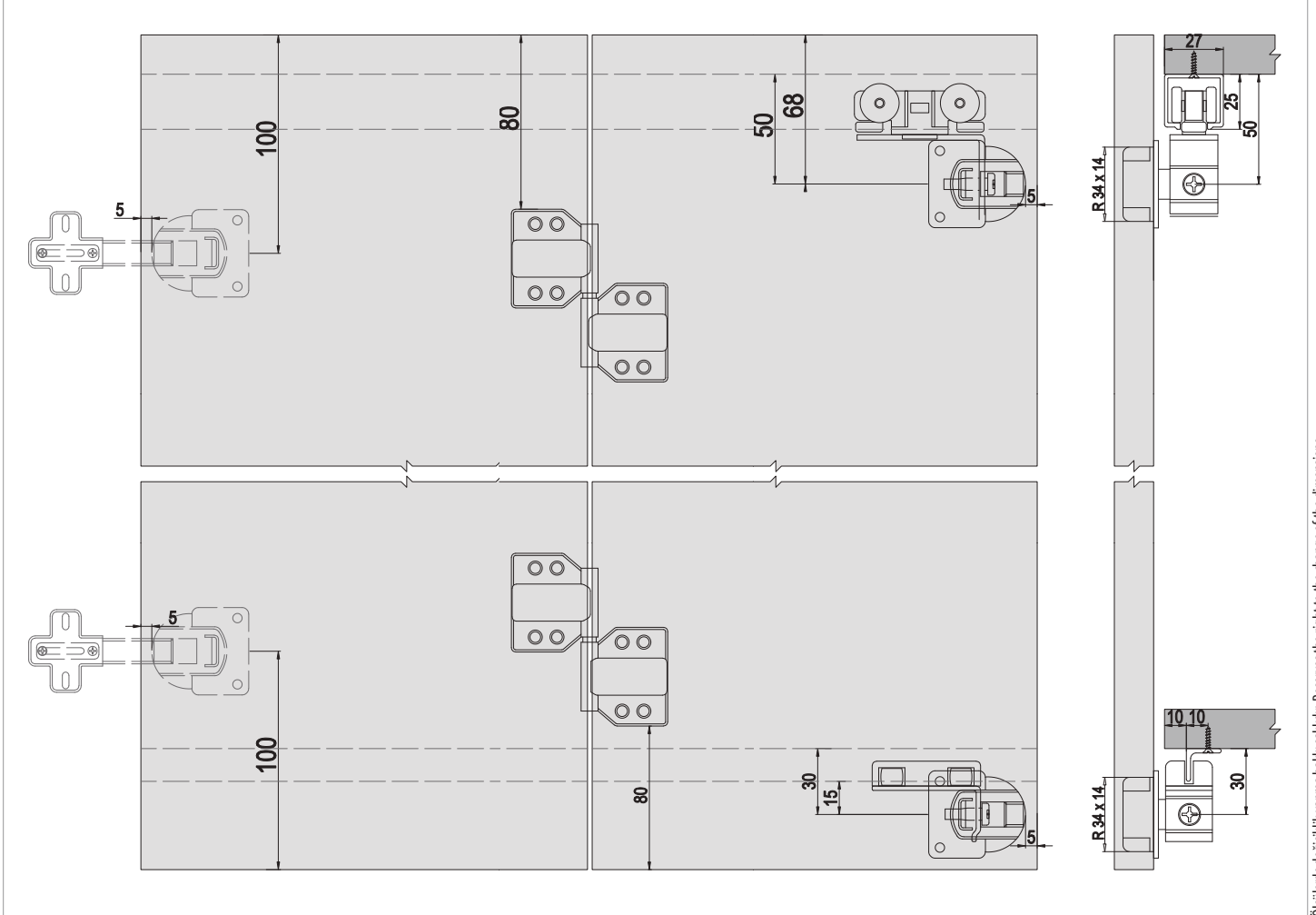

Ölçülerde değişiklik yapma hakkı saklıdır. Reserves the right to the change of the dimensions.

| Kod / Code No | Açıklama / Description | Renk / Colour | Birim / Unit | | | Profil mt. / Profiles mt. | Bağ / Bnd. |
|---------------|--|------------------------|-----------------|-----|-----|---------------------------|------------|
| 105-7400-1300 | 25 Kg Katlanır Gardirop Sistem / 25 Kg Folding Wardrobe System | Galvaniz / Galvanized | 1 Kapak / 1 Kit | 24 | 768 | - | - |
| 105-7423-1300 | Katlanır Kapak Sac Menteşe / Folding Door Sheet Iron Hinge | Galvaniz / Galvanized | 1 Adet / 1 Pcs | 250 | - | - | - |
| 105-7425-1300 | Katlanır Kapak Zamak Menteşe / Folding Door Zinc Hinge | Galvaniz / Galvanized | 1 Adet / 1 Pcs | 240 | - | - | - |
| 105-7426-1700 | Kulp Montaj Aparatı / Handle Assembly Kit | Gri / Grey | 1 Adet / 1 Pcs | 480 | - | - | - |
| 150-7450-1410 | Alüminyum Üst Ray Profili / Aluminium Top Rail Profile | Eloksal / Mat Anodized | mt. | - | - | 2,0 | 3,0 |
| 150-7460-1410 | Alüminyum Alt Ray Profili / Aluminium Bottom Rail Profile | Eloksal / Mat Anodized | mt. | - | - | 2,0 | 3,0 |

WingSlide 7405

25 KG KATLANIR SÜRME GARDIROP SİSTEMİ • SLIDING SYSTEM FOR FOLDING DOORS



Bilgi / Information

- Maksimum kapak yüksekliği 240 cm önerilir.
- Maksimum 25 kg / 1 kapak
- Maksimum kapak eni 60 cm önerilir.
- Max. height of 240 cm
- Maximum 25 kg / 1 door
- Maximum width 60 cm

Yavaşlatıcı Alternatifi / Soft Closer Alternative

- Katlanır kapak sistemlerinde yavaşlatıcı için, yavaşlatıcı menteşe tercih edebilirsiniz.
- For foldable door systems with soft closing, you can prefer soft closing hinge.



105-7405 1 Takım İçeriği / 1 Kit Includes

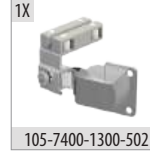

Ray Profilleri / Rail Profiles

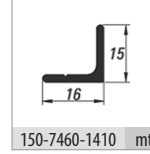
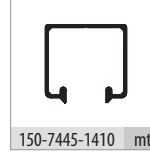

Opsiyonel / Optional

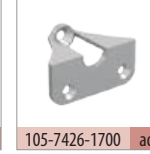
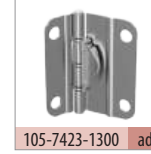

Teknik Detay / Technical Detail

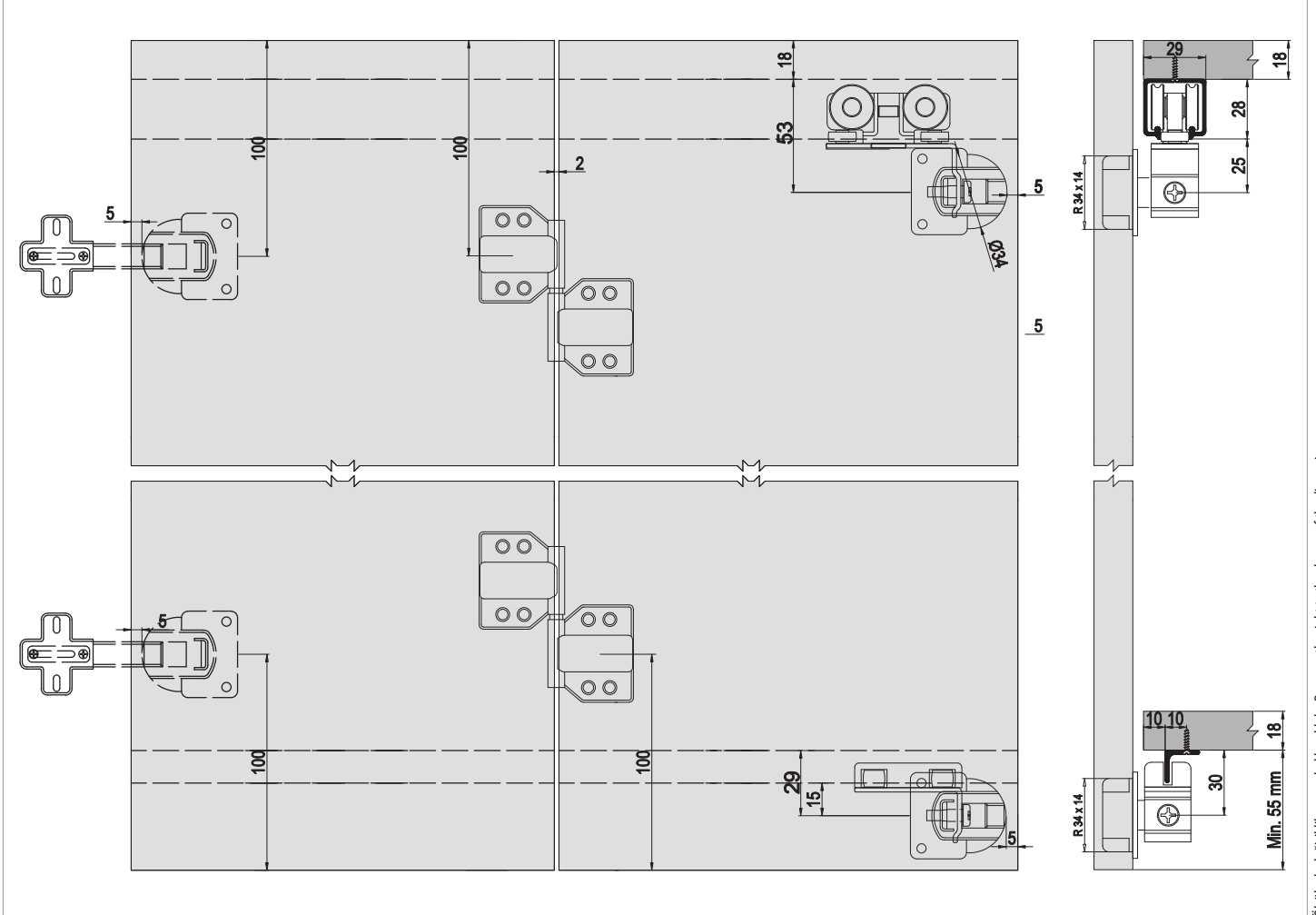

Ölçülerde değişiklik yapma hakkı saklıdır. Reserves the right to the change of the dimensions.

| Kod / Code No | Açıklama / Description | Renk / Colour | Birim / Unit | | | Profil mt. / Profiles mt. | Bağ / Bnd. |
|---------------|--|------------------------|-----------------|-----|-----|---------------------------|------------|
| 105-7405-1300 | 25 Kg Katlanır Gardirop Sistem / 25 Kg Folding Wardrobe System | Galvaniz / Galvanized | 1 Kapak / 1 Kit | 24 | 768 | - | - |
| 105-7423-1300 | Katlanır Kapak Sac Menteşe / Folding Door Sheet Iron Hinge | Galvaniz / Galvanized | 1 Adet / 1 Pcs | 250 | - | - | - |
| 105-7425-1300 | Katlanır Kapak Zamak Menteşe / Folding Door Zinc Hinge | Galvaniz / Galvanized | 1 Adet / 1 Pcs | 240 | - | - | - |
| 105-7426-1700 | Kulp Montaj Aparatı / Handle Assembly Kit | Gri / Grey | 1 Adet / 1 Pcs | 480 | - | - | - |
| 150-7445-1410 | Alüminyum Üst Ray Profili / Aluminium Top Rail Profile | Eloksal / Mat Anodized | mt. | - | - | 2,0 | 3,0 |
| 150-7460-1410 | Alüminyum Alt Ray Profili / Aluminium Bottom Rail Profile | Eloksal / Mat Anodized | mt. | - | - | 2,0 | 3,0 |



Bilgi / Information

- Maksimum kapak yüksekliği 150 cm önerilir.
- Maksimum 15 kg / 1 kapak
- Maksimum kapak eni 50 cm önerilir.
- Max. height of 150 cm
- Maximum 15 kg / 1 door
- Maximum width 50 cm

Yavaşlatıcı Alternatifi / Soft Closer Alternative

- Katlanır kapak sistemlerinde yavaşlatıcı için, yavaşlatıcı menteşe tercih edebilirsiniz.
- For foldable door systems with soft closing, you can prefer soft closing hinge.



105-7410 1 Takım İçeriği / 1 Kit Includes

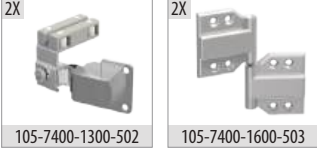

105-7400-1300-502

105-7400-1600-503

Ray Profilleri / Rail Profiles

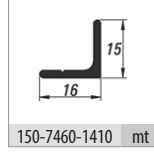

150-7460-1410 mt

Opsiyonel / Optional



105-7423-1300 ad.

105-7425-1300 ad.

105-7426-1700 ad.

Teknik Detay / Technical Detail

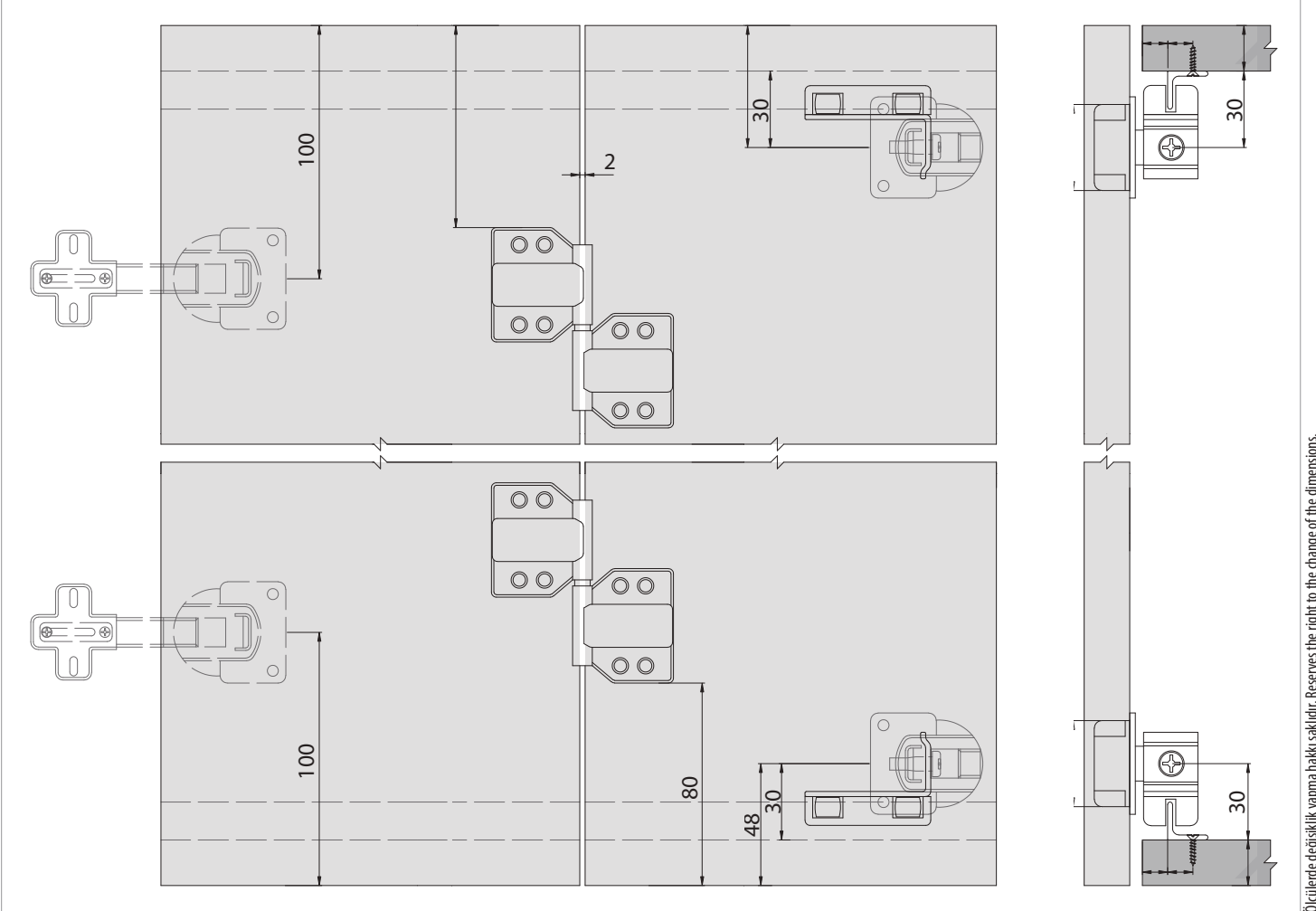

Ölçülerde değişiklik yapma hakkı saklıdır. Reserves the right to the change of the dimensions.

| Kod / Code No | Açıklama / Description | Renk / Colour | Birim / Unit | | | Profil mt. / Profiles mt. | Bağ / Bnd. |
|---------------|--|------------------------|-----------------|-----|-----|---------------------------|------------|
| 105-7410-1300 | 25 Kg Katlanır Gardirop Sistem / 25 Kg Folding Wardrobe System | Galvaniz / Galvanized | 1 Kapak / 1 Kit | 24 | 768 | - - - | - |
| 105-7423-1300 | Katlanır Kapak Sac Menteşe / Folding Door Sheet Iron Hinge | Galvaniz / Galvanized | 1 Adet / 1 Pcs | 250 | - | - - - | - |
| 105-7425-1300 | Katlanır Kapak Zamak Menteşe / Folding Door Zinc Hinge | Galvaniz / Galvanized | 1 Adet / 1 Pcs | 240 | - | - - - | - |
| 105-7426-1700 | Kulp Montaj Aparatı / Handle Assembly Kit | Gri / Grey | 1 Adet / 1 Pcs | 480 | - | - - - | - |
| 150-7460-1410 | Alüminyum Alt Ray Profili / Aluminium Bottom Rail Profile | Eloksal / Mat Anodized | mt. | - | - | 2,0 - 3,0 | 12 ad/pcs |

WingSlide 7420

40 KG KATLIR SÜRME GARDIROP SİSTEMİ • SLIDING SYSTEM FOR FOLDING DOORS



Bilgi / Information

- Maksimum kapak yüksekliği 240 cm önerilir.
- Maksimum 40 kg / 1 kapak
- Maksimum kapak eni 60 cm önerilir.
- Max. height of 240 cm
- Maximum 40 kg / 1 door
- Maximum width 60 cm

Yavaşlatıcı Alternatifi / Soft Closer Alternative

- Katlanır kapak sistemlerinde yavaşlatıcı için, yavaşlatıcı menteşe tercih edebilirsiniz.
- For foldable door systems with soft closing, you can prefer soft closing hinge.



105-7420 1 Takım İçeriği / 1 Kit Includes



Ray Profilleri / Rail Profiles

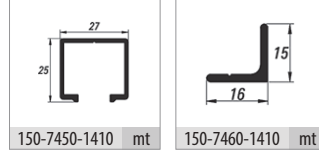

Opsiyonel / Optional



Teknik Detay / Technical Detail

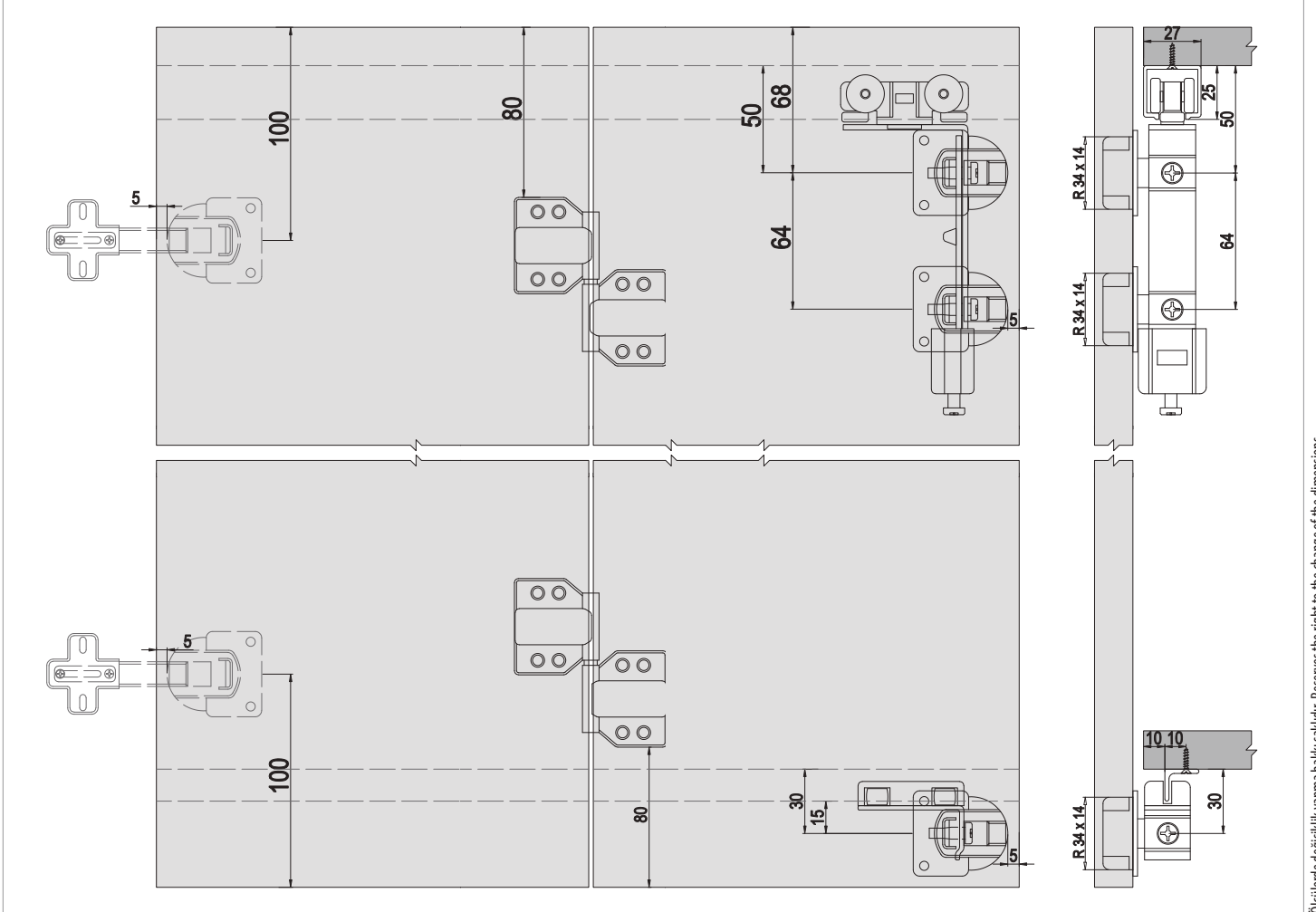

Ölçülerde değişiklik yapma hakkı saklıdır. Reserves the right to the change of the dimensions.

| Kod / Code No | Açıklama / Description | Renk / Colour | Birim / Unit | | | Profil mt. / Profiles mt. | Bağ / Bnd. |
|---------------|--|------------------------|-----------------|-----|-----|---------------------------|------------|
| 105-7420-1300 | 40 Kg Katlanır Gardirop Sistem / 40 Kg Folding Wardrobe System | Galvaniz / Galvanized | 1 Kapak / 1 Kit | 24 | 576 | - | - |
| 105-7423-1300 | Katlanır Kapak Sac Menteşe / Folding Door Sheet Iron Hinge | Galvaniz / Galvanized | 1 Adet / 1 Pcs | 250 | - | - | - |
| 105-7425-1300 | Katlanır Kapak Zamak Menteşe / Folding Door Zinc Hinge | Galvaniz / Galvanized | 1 Adet / 1 Pcs | 240 | - | - | - |
| 105-7426-1700 | Kulp Montaj Aparatı / Handle Assembly Kit | Gri / Grey | 1 Adet / 1 Pcs | 480 | - | - | - |
| 150-7450-1410 | Alüminyum Üst Ray Profili / Aluminium Top Rail Profile | Eloksal / Mat Anodized | mt. | - | - | 2,0 | 3,0 |
| 150-7460-1410 | Alüminyum Alt Ray Profili / Aluminium Bottom Rail Profile | Eloksal / Mat Anodized | mt. | - | - | 2,0 | 3,0 |

WingSlide 7430

40 KG KATLANIR SÜRME GARDIROP SİSTEMİ • SLIDING SYSTEM FOR FOLDING DOORS



Bilgi / Information

- Maksimum kapak yüksekliği 240 cm önerilir.
- Maksimum 40 kg / 1 kapak
- Maksimum kapak eni 60 cm önerilir.
- Max. height of 240 cm
- Maximum 40 kg / 1 door
- Maximum width 60 cm

Yavaşlatıcı Alternatifi / Soft Closer Alternative

- Katlanır kapak sistemlerinde yavaşlatıcı için, yavaşlatıcı menteşe tercih edebilirsiniz.
- For foldable door systems with soft closing, you can prefer soft closing hinge.



105-7430 1 Takım İçeriği / 1 Kit Includes

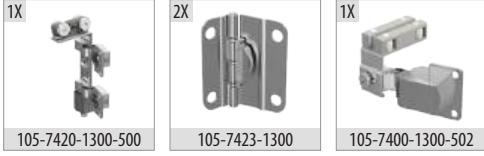

Ray Profilleri / Rail Profiles

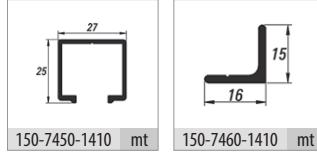

Opsiyonel / Optional



Teknik Detay / Technical Detail

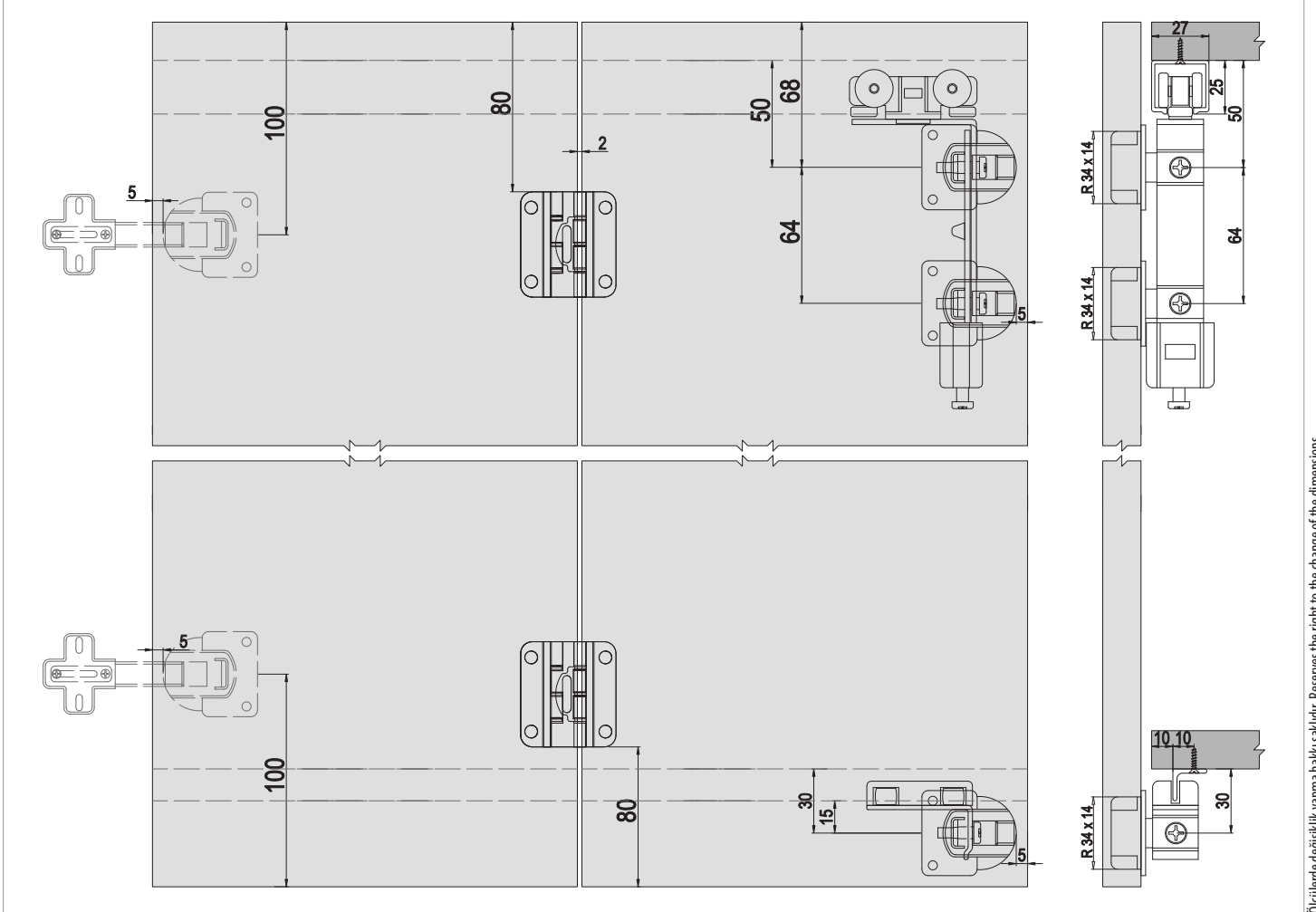

Ölçülerde değişiklik yapma hakkı saklıdır. Reserves the right to the change of the dimensions.

| Kod / Code No | Açıklama / Description | Renk / Colour | Birim / Unit | | | Profil mt. / Profiles mt. | Bağ / Bnd. |
|---------------|--|------------------------|-----------------|-----|-----|---------------------------|------------|
| 105-7430-1300 | 40 Kg Katlanır Gardirop Sistem / 40 Kg Folding Wardrobe System | Galvaniz / Galvanized | 1 Kapak / 1 Kit | 24 | 576 | - | - |
| 105-7423-1300 | Katlanır Kapak Sac Menteşe / Folding Door Sheet Iron Hinge | Galvaniz / Galvanized | 1 Adet / 1 Pcs | 250 | - | - | - |
| 105-7425-1300 | Katlanır Kapak Zamak Menteşe / Folding Door Zinc Hinge | Galvaniz / Galvanized | 1 Adet / 1 Pcs | 240 | - | - | - |
| 105-7426-1700 | Kulp Montaj Aparatı / Handle Assembly Kit | Gri / Grey | 1 Adet / 1 Pcs | 480 | - | - | - |
| 150-7450-1410 | Alüminyum Üst Ray Profili / Aluminium Top Rail Profile | Eloksal / Mat Anodized | mt. | - | - | 2,0 | 3,0 |
| 150-7460-1410 | Alüminyum Alt Ray Profili / Aluminium Bottom Rail Profile | Eloksal / Mat Anodized | mt. | - | - | 2,0 | 3,0 |

WingSlide 7440

40 KG KATLANIR SÜRME GARDIROP SİSTEMİ • SLIDING SYSTEM FOR FOLDING DOORS



Bilgi / Information

- Maksimum kapak yüksekliği 240 cm önerilir.
- Maksimum 40 kg / 1 kapak
- Maksimum kapak eni 60 cm önerilir.
- 2 mt'nin üzerindeki kapaklarda ilave menteşe kullanılmalıdır.
- Max. height of 240 cm
- Maximum 40 kg / 1 door
- Maximum width 60 cm
- Should be used additional hinges over 2 mt doors

Yavaşlatıcı Alternatifi / Soft Closer Alternative

- Katlanır kapak sistemlerinde yavaşlatıcı için, yavaşlatıcı menteşe tercih edebilirsiniz.
- For foldable door systems with soft closing, you can prefer soft closing hinge.



105-7440 1 Takım İçeriği / 1 Kit Includes

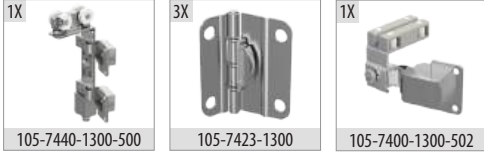

Ray Profilleri / Rail Profiles

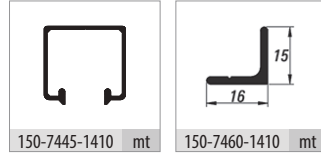

Opsiyonel / Optional



Teknik Detay / Technical Detail

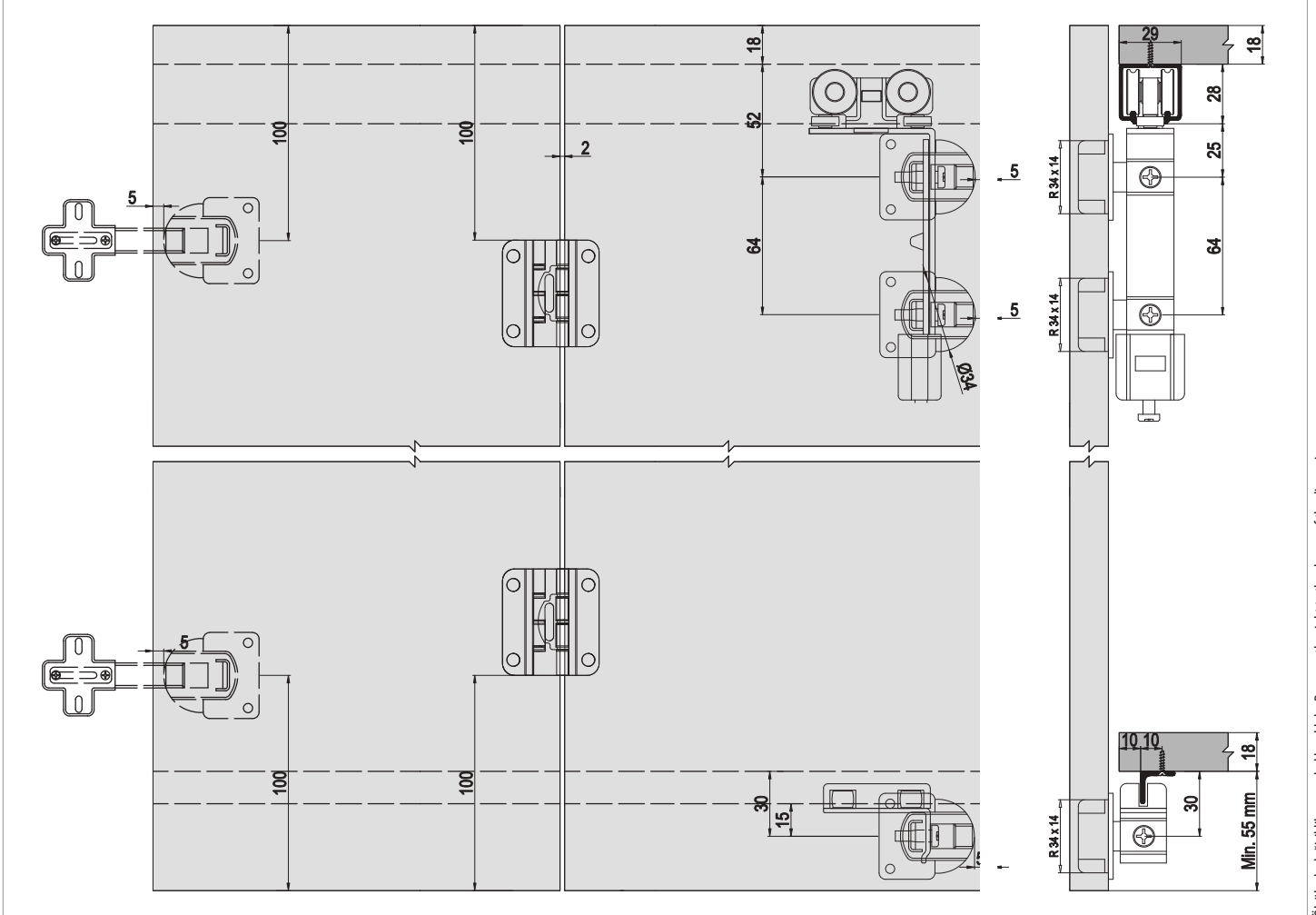

Ölçülerde değişiklik yapma hakkı saklıdır. Reserves the right to the change of the dimensions.

| Kod / Code No | Açıklama / Description | Renk / Colour | Birim / Unit | | | Profil mt. / Profiles mt. | Bağ / Bnd. |
|---------------|--|------------------------|-----------------|-----|-----|---------------------------|------------|
| 105-7440-1300 | 40 Kg Katlanır Gardirop Sistem / 40 Kg Folding Wardrobe System | Galvaniz / Galvanized | 1 Kapak / 1 Kit | 24 | 576 | - | - |
| 105-7423-1300 | Katlanır Kapak Sac Menteşe / Folding Door Sheet Iron Hinge | Galvaniz / Galvanized | 1 Adet / 1 Pcs | 250 | - | - | - |
| 105-7425-1300 | Katlanır Kapak Zamak Menteşe / Folding Door Zinc Hinge | Galvaniz / Galvanized | 1 Adet / 1 Pcs | 240 | - | - | - |
| 105-7426-1700 | Kulp Montaj Aparatı / Handle Assembly Kit | Gri / Grey | 1 Adet / 1 Pcs | 480 | - | - | - |
| 150-7445-1410 | Alüminyum Üst Ray Profili / Aluminium Top Rail Profile | Eloksal / Mat Anodized | mt. | - | - | 2,0 | 3,0 |
| 150-7460-1410 | Alüminyum Alt Ray Profili / Aluminium Bottom Rail Profile | Eloksal / Mat Anodized | mt. | - | - | 2,0 | 3,0 |



Bilgi / Information

- Maksimum kapak yüksekliği 240 cm önerilir.
- Maksimum 40 kg / 1 kapak
- Maksimum kapak eni 60 cm önerilir.
- 2 m'nin üzerindeki kapaklarda ilave menteşe kullanılmalıdır.
- Max. height of 240 cm
- Maximum 40 kg / 1 door
- Maximum width 60 cm
- Should be used additional hinges over 2 mt doors



Yavaşlatıcı Alternatifi / Soft Closer Alternative

- Katlanır kapak sistemlerinde yavaşlatıcı için, yavaşlatıcı menteşe tercih edebilirsiniz.
- For foldable door systems with soft closing, you can prefer soft closing hinge.

105-7441 1 Takım İçeriği / 1 Kit Includes

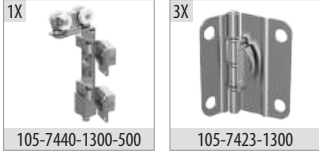

Ray Profilleri / Rail Profiles

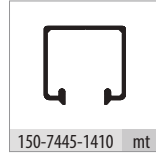

Opsiyonel / Optional



Teknik Detay / Technical Detail

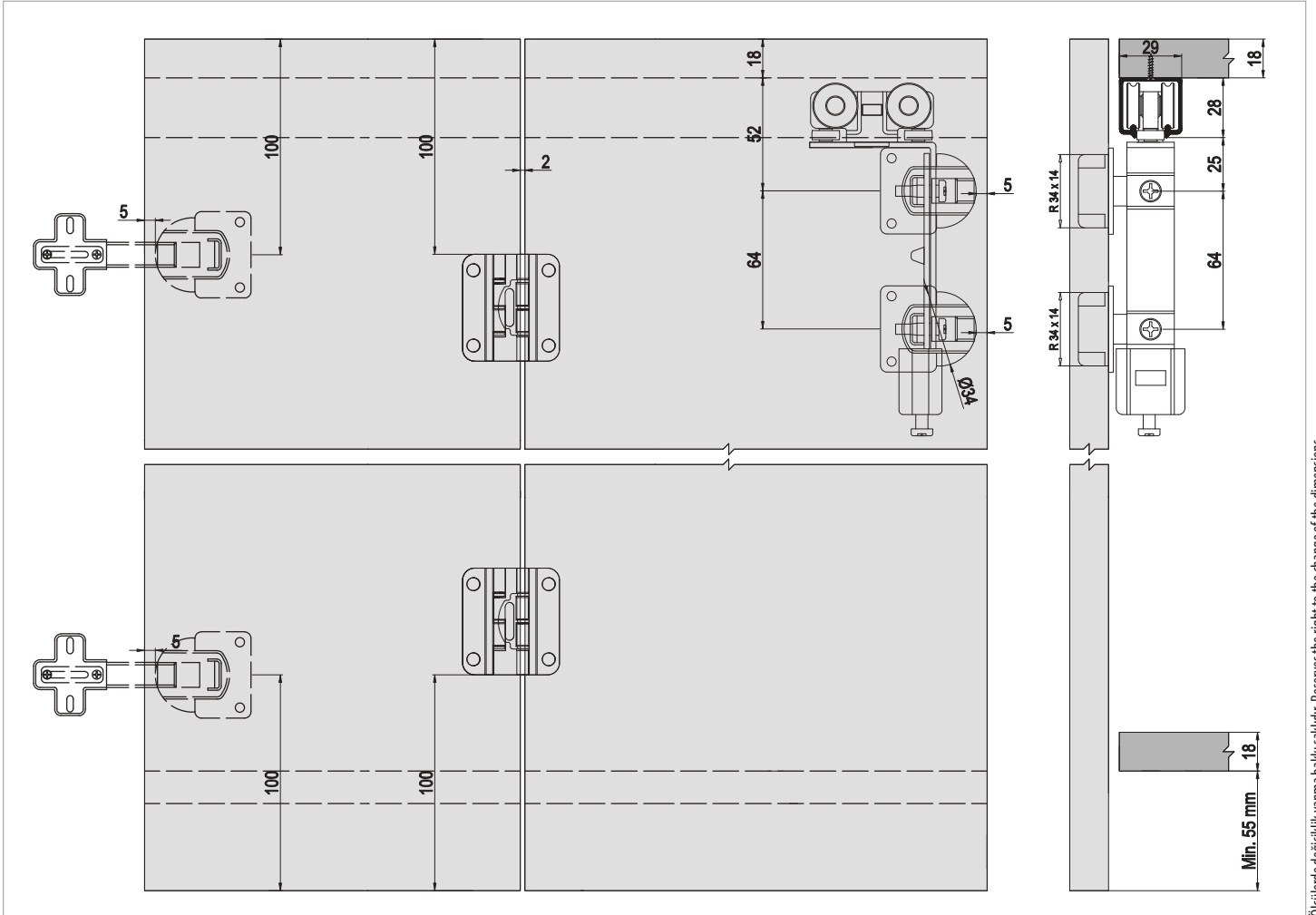

Ölçülerde değişiklik yapma hakkı saklıdır. Reserves the right to the change of the dimensions.

| Kod / Code No | Açıklama / Description | Renk / Colour | Birim / Unit | | | Profil mt. / Profiles mt. | Bağ / Bnd. |
|---------------|--|------------------------|-----------------|-----|-----|---------------------------|------------|
| 105-7441-1300 | 40 Kg Katlanır Gardirop Sistem / 40 Kg Folding Wardrobe System | Galvaniz / Galvanized | 1 Kapak / 1 Kit | 24 | 576 | - - - | - |
| 105-7423-1300 | Katlanır Kapak Sac Menteşe / Folding Door Sheet Iron Hinge | Galvaniz / Galvanized | 1 Adet / 1 Pcs | 250 | - | - - - | - |
| 105-7425-1300 | Katlanır Kapak Zamak Menteşe / Folding Door Zinc Hinge | Galvaniz / Galvanized | 1 Adet / 1 Pcs | 240 | - | - - - | - |
| 105-7426-1700 | Kulp Montaj Aparatı / Handle Assembly Kit | Gri / Grey | 1 Adet / 1 Pcs | 480 | - | - - - | - |
| 150-7445-1410 | Alüminyum Üst Ray Profili / Aluminium Top Rail Profile | Eloksal / Mat Anodized | mt. | - | - | 2,0 - 3,0 | 12 ad/pcs |

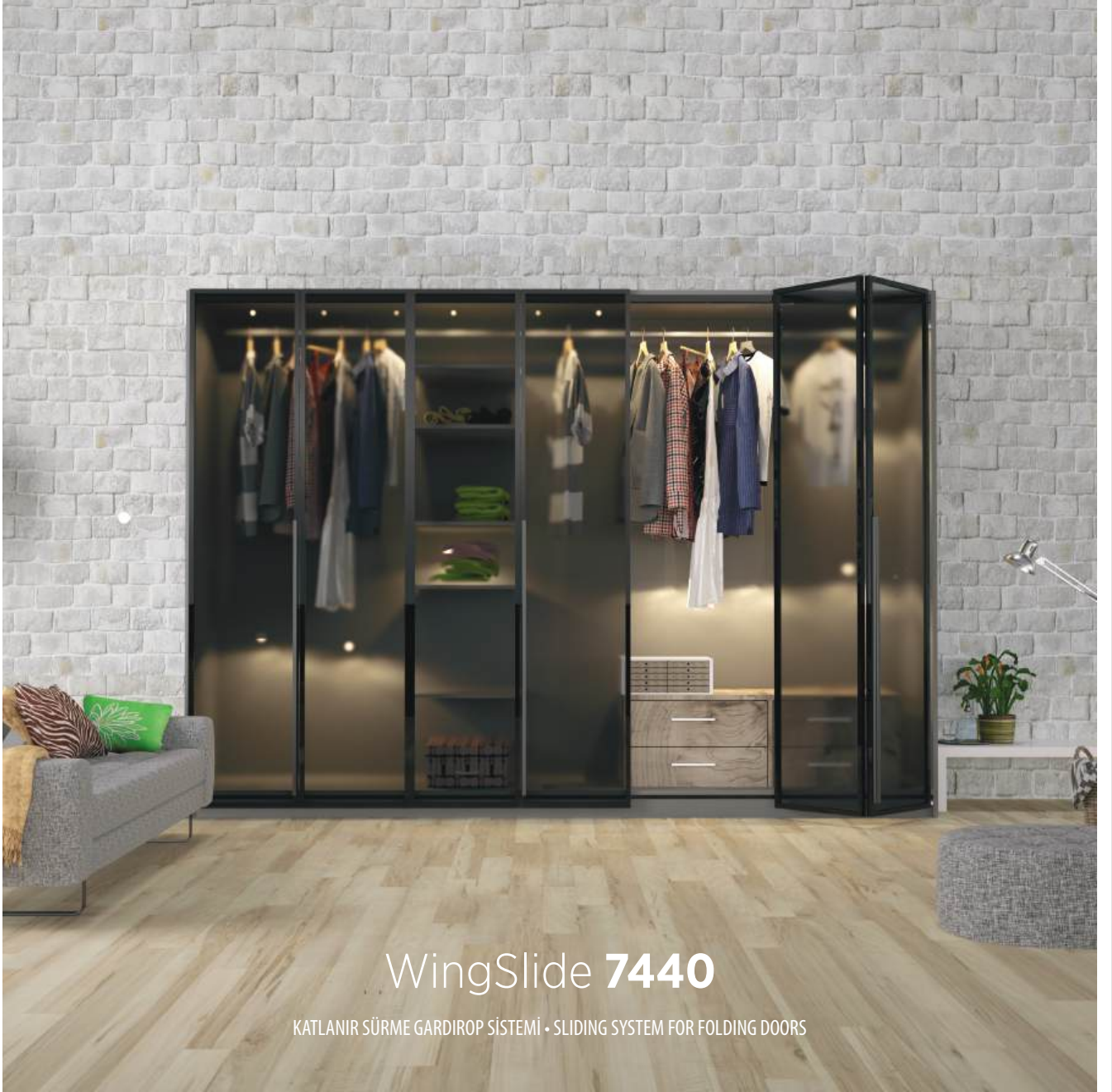

Group 108

Glassline[®]

Sürme Cam Kapak Serisi

Sliding Glass Door Series



Bu serideki tüm ürünleri incelemek için QR kodu okutabilirsiniz.

You can search the QR code to see all the products in these series.

Glassline

ALÜMİNYUM ÇERÇEVE SÜRGÜ SİSTEMİ • SLIDING ALUMINIUM DOOR SYSTEM

Group **108**

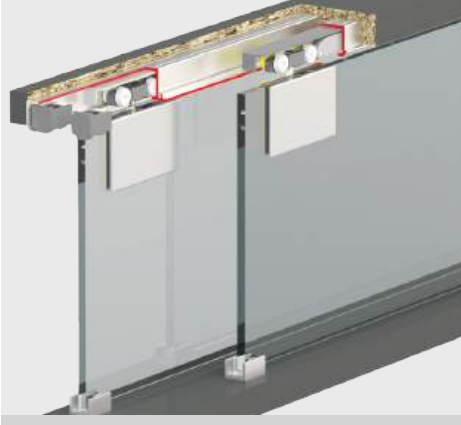

Glassline **2**



Glassline **7500**

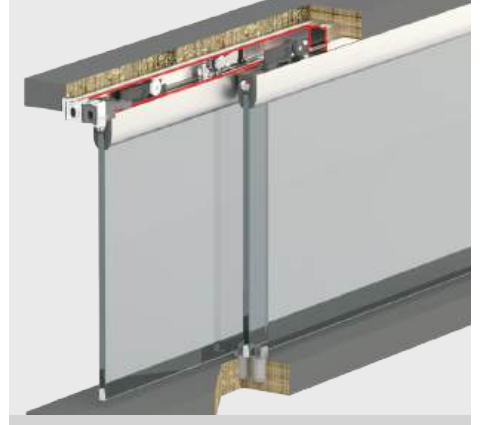

Glassline **7600**

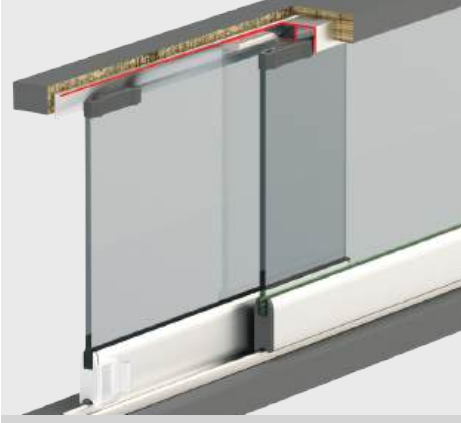

Glassline **7700**



Glassline **7702**

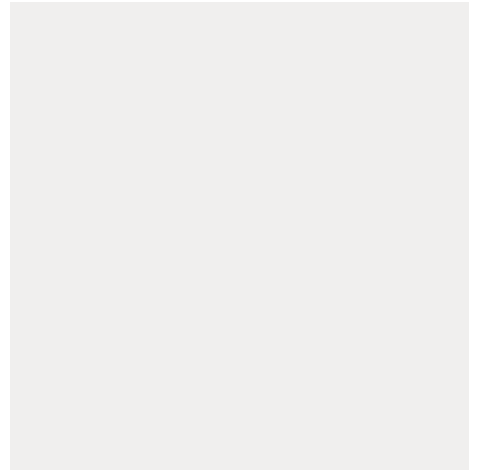
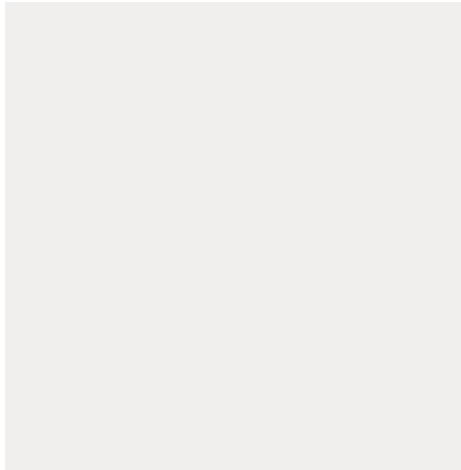
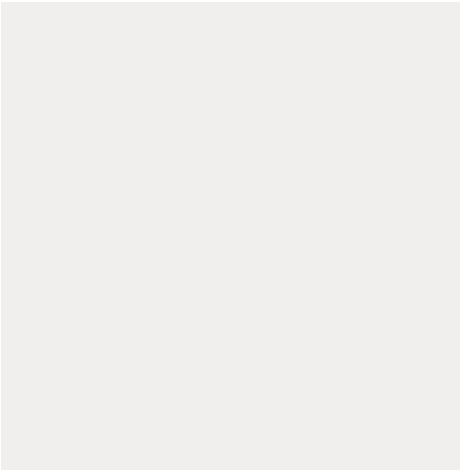
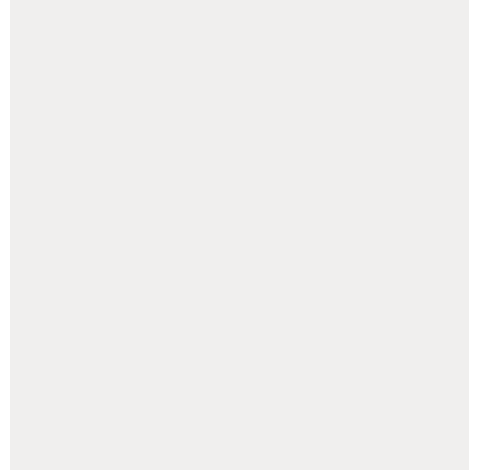
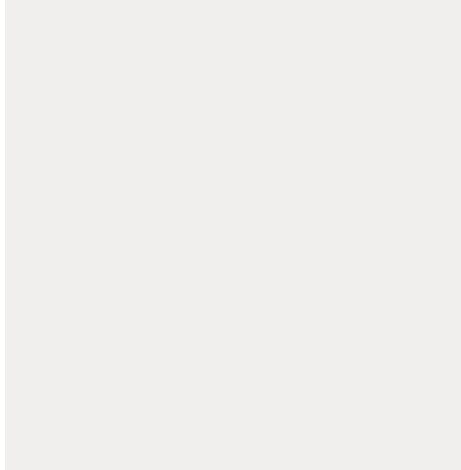
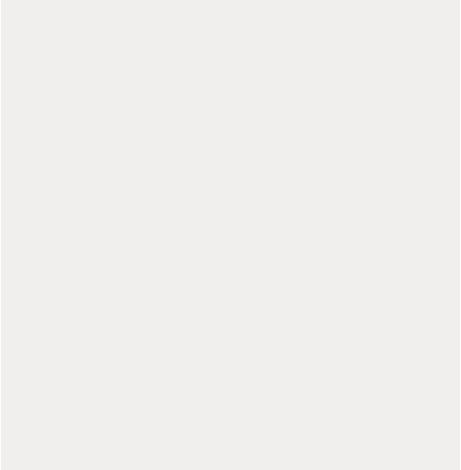
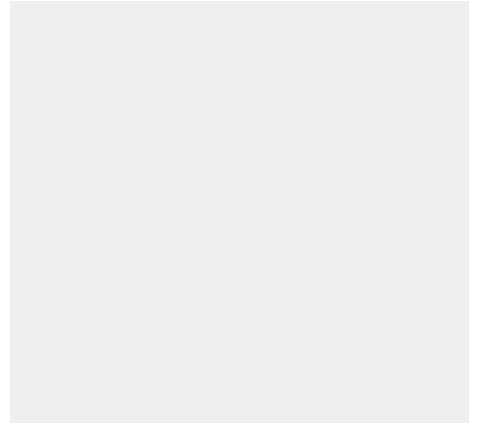

Glassline 2

20 KG SÜRME YAVAŞLATICILI CAM KAPAK SİSTEMİ • SOFT CLOSING SLIDING GLASS DOOR SYSTEM

Yeni Ürün
New Product

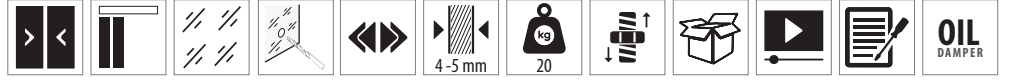
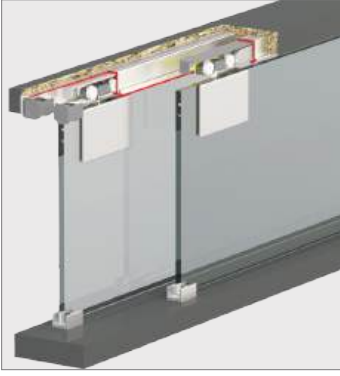

■ Yavaşlatıcı Alternatifi / Soft Closer Alternative

- Sistem üzerinde entegre yavaşlatıcı mevcuttur.
- The system has integrated soft closer.



■ 108-7020 1 Takım İçeriği / 1 Kit Includes

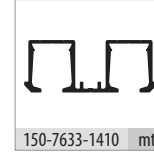
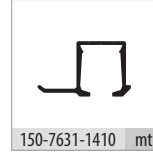
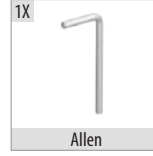
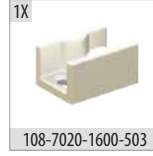
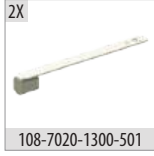

■ Ray Profilleri / Rail Profiles

■ Teknik Detay / Technical Detail

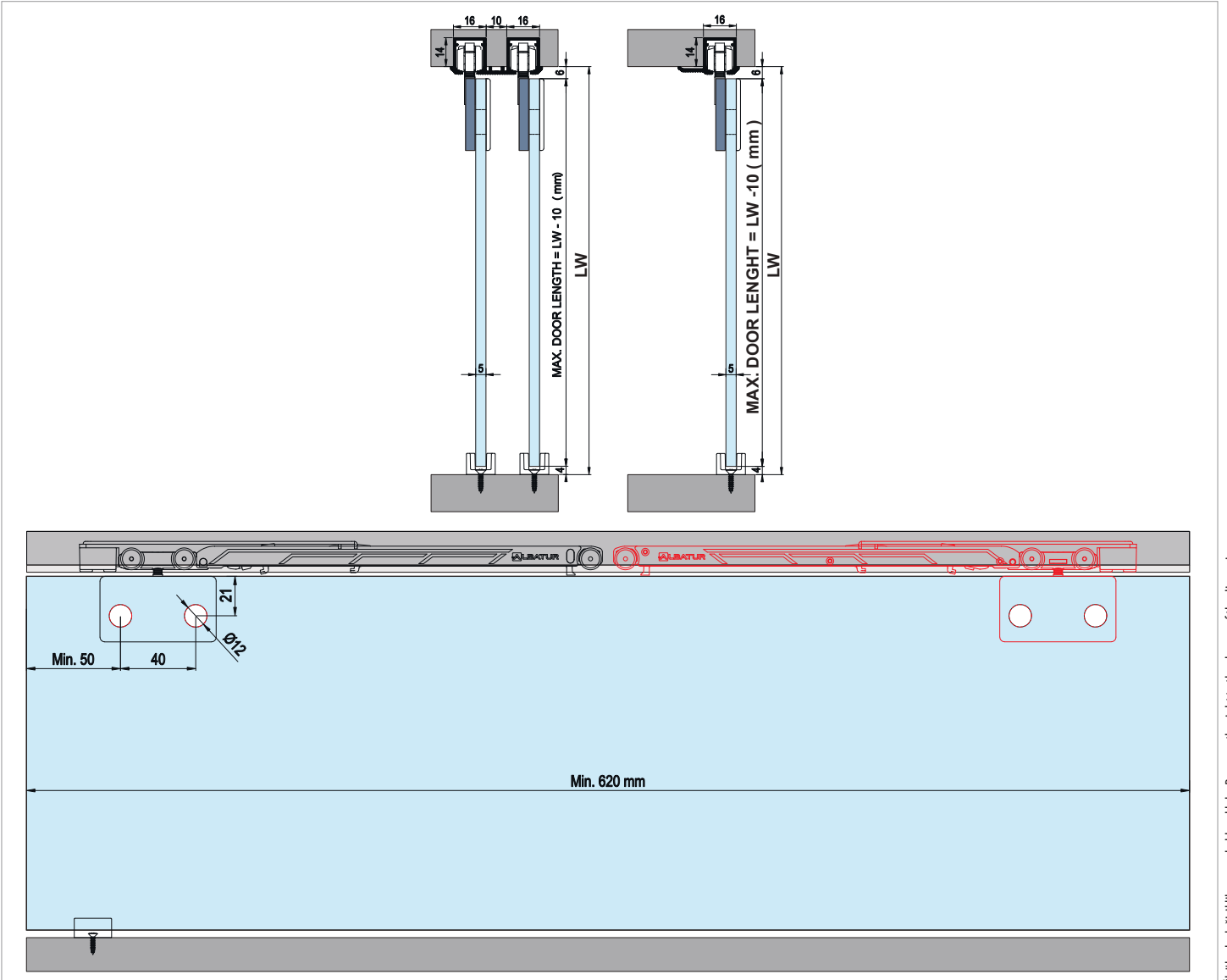

Özelliklerde değişiklik yapma hakkı saklıdır. Reserves the right to the change of the dimensions.

| Kod / Code No | Açıklama / Description | Renk / Colour | Birim / Unit | | | Profil mt. / Profiles mt. | Bağ / Bnd. |
|---------------|---|------------------------|-----------------|----|-----|---------------------------|------------|
| 108-7020-1600 | Glassline 2 - 20 Kg Sürme Cam Kapak Sistemi / 20 Kg Sliding Glass Door System | Gri / Grey | 1 Kapak / 1 Kit | 12 | 360 | - | - |
| 150-7631-1410 | Alüminyum Üst Ray Profili / Aluminium Top Rail Profile | Eloksal / Mat Anodized | mt. | - | - | - | 3,0 |
| 150-7633-1410 | Alüminyum Üst Ray Profili / Aluminium Top Rail Profile | Eloksal / Mat Anodized | mt. | - | - | - | 3,0 |



albaturas.com

Glassline 7500

25 KG ALÜMİNYUM ÇERÇEVE SÜRGÜ SİSTEMİ • SLIDING ALUMINIUM DOOR SYSTEM

Özel Üretim
Special Production



108-7500 1 Takım İçeriği / 1 Kit Includes

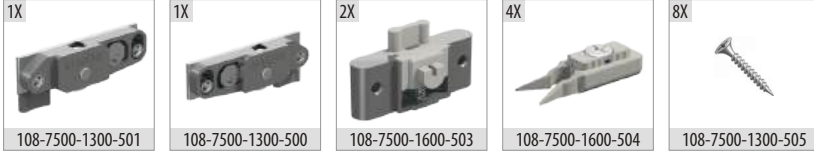

Ray Profilleri / Rail Profiles

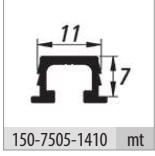

Örnek Uygulama Profilleri / Sample Application Profiles

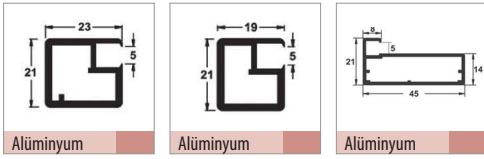

Uygulama / Application



Teknik Detay / Technical Detail

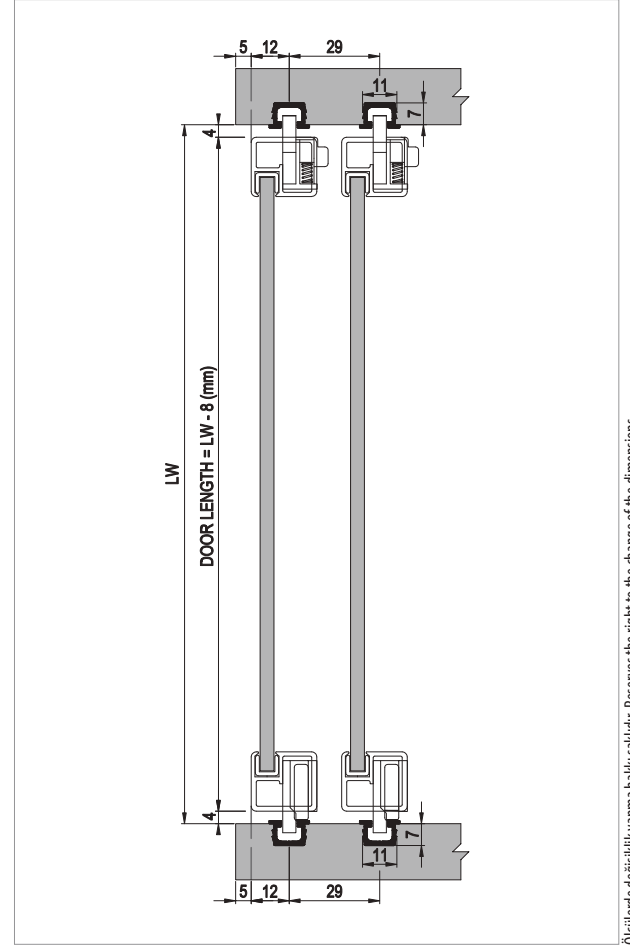

Özelliklerde değişiklik yapma hakkı saklıdır. Reserves the right to the change of the dimensions.

| Kod / Code No | Açıklama / Description | Renk / Colour | Birim / Unit | | | Profil mt. / Profiles mt. | Bağ / Bnd. |
|---------------|--|------------------------|-----------------|----|-------|---------------------------|------------|
| 108-7500-1300 | Glassline 7500 - 25 Kg Sürme Cam Kapak Sistemi / 25 Kg Sliding Glass Door System | Galvaniz / Galvanized | 1 Kapak / 1 Kit | 20 | 2.400 | - - - | - |
| 150-7505-1410 | Alüminyum Ray Profili / Aluminium Rail Profile | Eloksal / Mat Anodized | mt. | - | - | - - 3,0 | 30 ad/pcs |

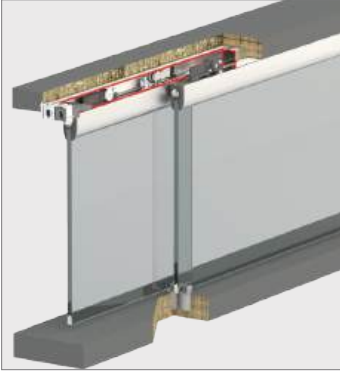

108-7600 1 Takım İçeriği / 1 Kit Includes



Ray Profilleri / Rail Profiles

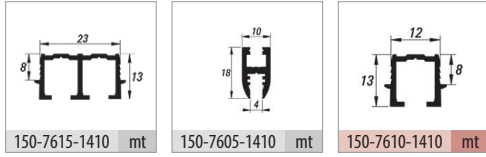

Teknik Detay / Technical Detail

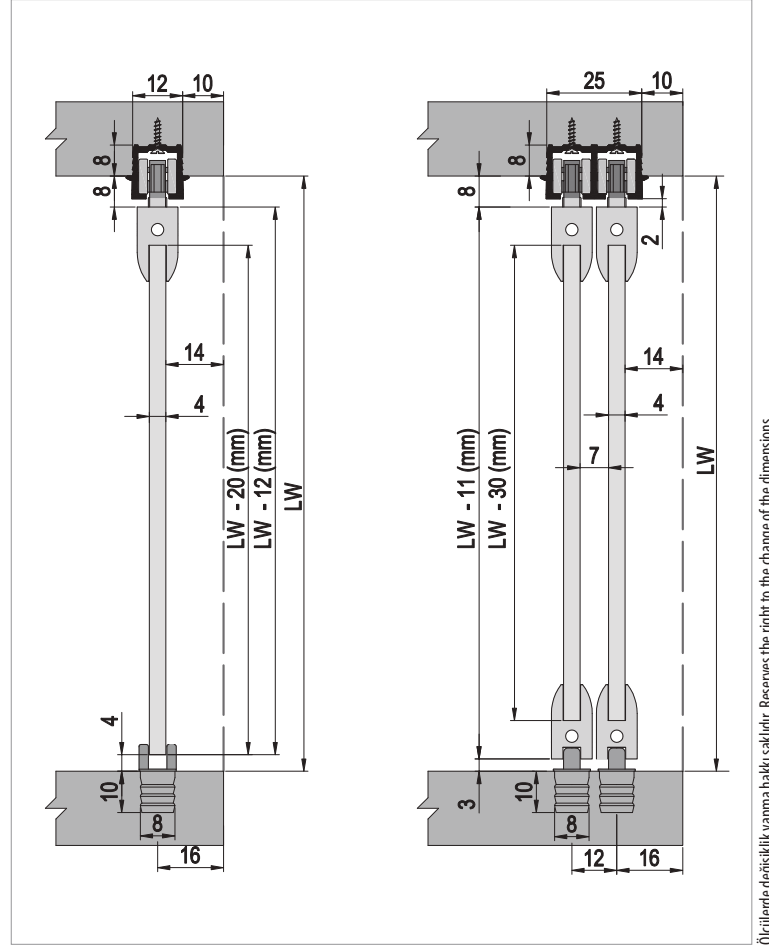

Ölçülerde değişiklik yapma hakkı saklıdır. Reserves the right to the change of the dimensions.

| Kod / Code No | Açıklama / Description | Renk / Colour | Birim / Unit | | | Profil mt. / Profiles mt. | Bağ / Bnd. |
|---------------|--|------------------------|-----------------|----|-------|---------------------------|---------------|
| 108-7600-1600 | Glassline 7600 - 15 Kg Sürme Cam Kapak Sistemi / 15 Kg Sliding Glass Door System | Gri / Grey | 1 Kapak / 1 Kit | 20 | 2.400 | - | - |
| 150-7615-1410 | Alüminyum Üst Ray Profili / Aluminium Top Rail Profile | Eloksal / Mat Anodized | mt. | - | - | - | 3,0 10 ad/pcs |
| 150-7610-1410 | Alüminyum Üst Ray Profili / Aluminium Top Rail Profile | Eloksal / Mat Anodized | mt. | - | - | - | 3,0 10 ad/pcs |
| 150-7605-1410 | Alüminyum Cam Tutucu / Aluminium Frame | Eloksal / Mat Anodized | mt. | - | - | - | 3,0 10 ad/pcs |

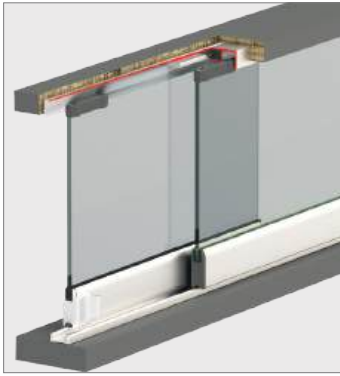

Bilgi / Information

- 4 mm uygulama için 145.1015.1640 fitil kullanılmalıdır.
- For 4 mm applications should use 145.1015.1640 wick.



108-7700 1 Takım İçeriği - Kutuda 2 takım / 1 Kit Includes - 2 Set in a Box

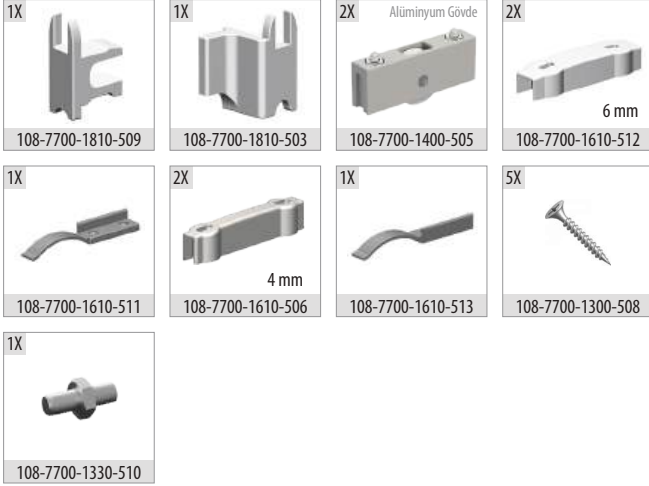

Ray Profilleri / Rail Profiles

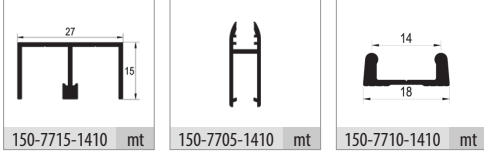

Opsiyonel Aksesuar / Optional Accessories



Teknik Detay / Technical Detail

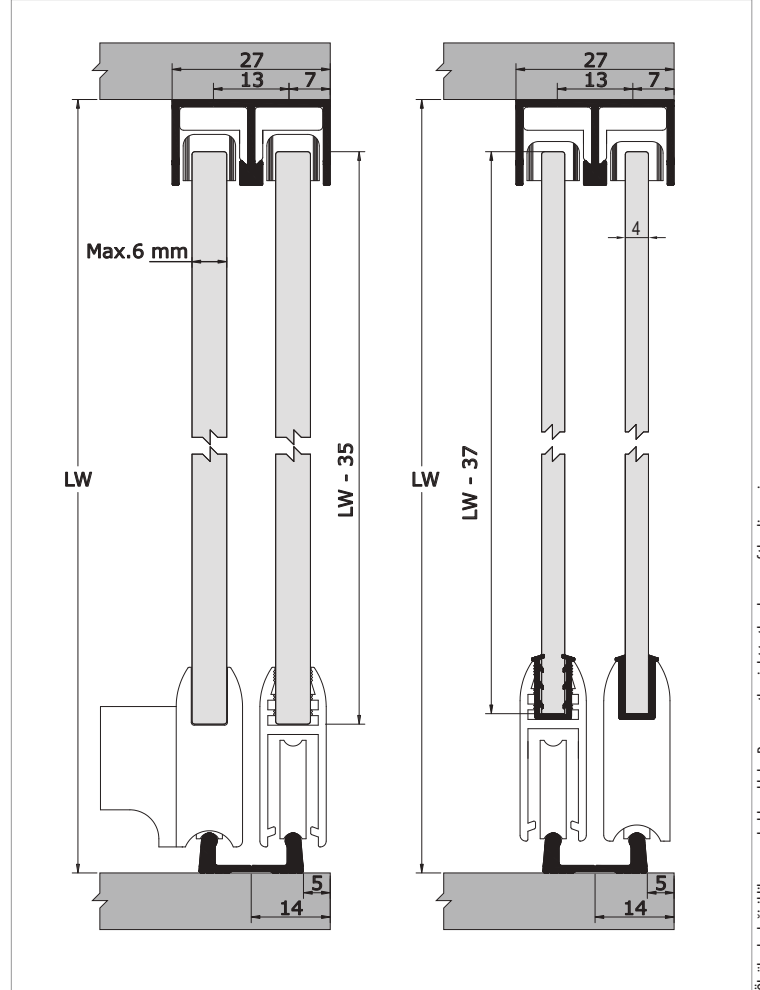

Ölçülerde değişiklik yapma hakkı saklıdır. Reserves the right to the change of the dimensions.

| Kod / Code No | Açıklama / Description | Renk / Colour | Birim / Unit | | | Profil mt. / Profiles mt. | Bağ / Bnd. |
|---------------|--|------------------------|-----------------|-----|-------|---------------------------|------------|
| 108-7700-1400 | Glassline 7700 - 25 Kg Sürme Cam Kapak Sistemi / 25 Kg Sliding Glass Door System | Gri / Grey | 1 Kapak / 1 Kit | 30 | 1.920 | - - - | - |
| 145-1015-1640 | 4 mm Cam Fitili / 4 mm Glass Wick | Şeffaf / Transparan | mt. | 100 | 3.600 | - - - | - |
| 150-7715-1410 | Alüminyum Üst Ray Profili / Aluminium Top Rail Profile | Eloksal / Mat Anodized | mt. | - | - | 2,0 - 3,0 | 10 ad/pcs |
| 150-7705-1410 | Alüminyum Cam Tutucu / Aluminium Frame | Eloksal / Mat Anodized | mt. | - | - | 2,0 - 3,0 | 10 ad/pcs |
| 150-7710-1410 | Alüminyum Alt Ray Profili / Aluminium Bottom Rail Profile | Eloksal / Mat Anodized | mt. | - | - | 2,0 - 3,0 | 10 ad/pcs |

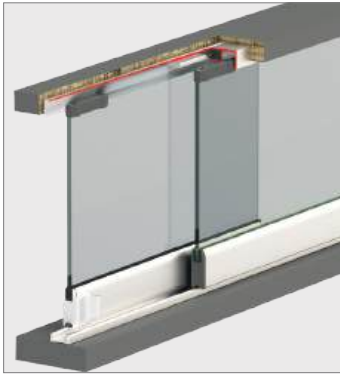

Bilgi / Information

- 4 mm uygulama için 145.1015.1640 fitil kullanılmalıdır.
- For 4 mm applications should be use 145.1015.1640 wick.



108-7702 1 Takım İçeriği - Kutuda 2 takım / 1 Kit Includes - 2 Set in a Box

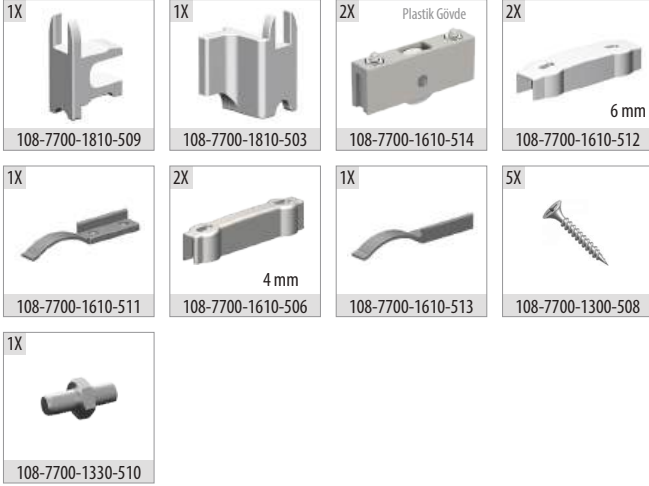

Ray Profilleri / Rail Profiles

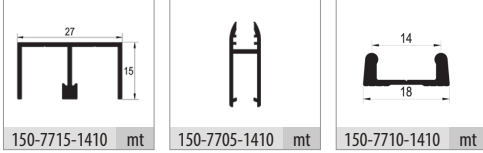

Opsiyonel Aksesuar / Optional Accessories



Teknik Detay / Technical Detail

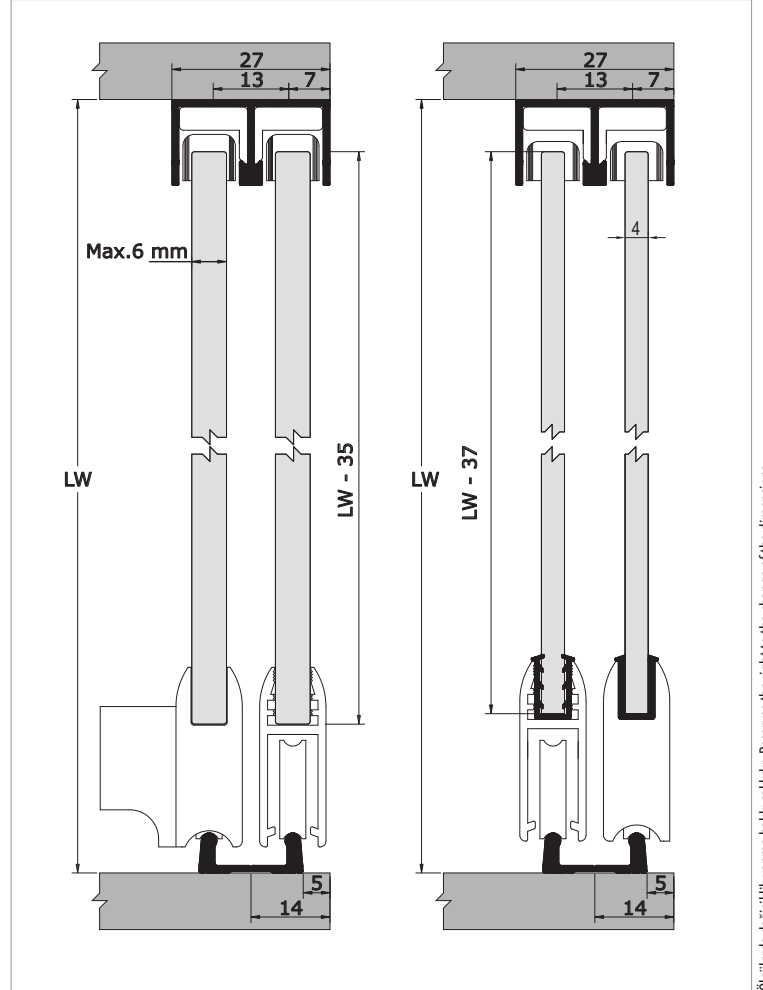

Ölçülerde değişiklik yapma hakkı saklıdır. Reserves the right to the change of the dimensions.

| Kod / Code No | Açıklama / Description | Renk / Colour | Birim / Unit | | | Profil mt. / Profiles mt. | Bağ / Bnd. |
|---------------|--|------------------------|-----------------|-----|-------|---------------------------|------------|
| 108-7702-1600 | Glassline 7702 - 25 Kg Sürme Cam Kapak Sistemi / 25 Kg Sliding Glass Door System | Gri / Grey | 1 Kapak / 1 Kit | 30 | 1.920 | - - - | - |
| 145-1015-1640 | 4 mm Cam Fitili / 4 mm Glass Wick | Şeffaf / Transparan | mt. | 100 | 3.600 | - - - | - |
| 150-7715-1410 | Alüminyum Üst Ray Profili / Aluminium Top Rail Profile | Eloksal / Mat Anodized | mt. | - | - | 2,0 - 3,0 | 10 ad/pcs |
| 150-7705-1410 | Alüminyum Cam Tutucu / Aluminium Frame | Eloksal / Mat Anodized | mt. | - | - | 2,0 - 3,0 | 10 ad/pcs |
| 150-7710-1410 | Alüminyum Alt Ray Profili / Aluminium Bottom Rail Profile | Eloksal / Mat Anodized | mt. | - | - | 2,0 - 3,0 | 10 ad/pcs |

Group 109

Rigel®

Sürme Ray Dolap Serisi
Sliding Rail Wardrobe Series

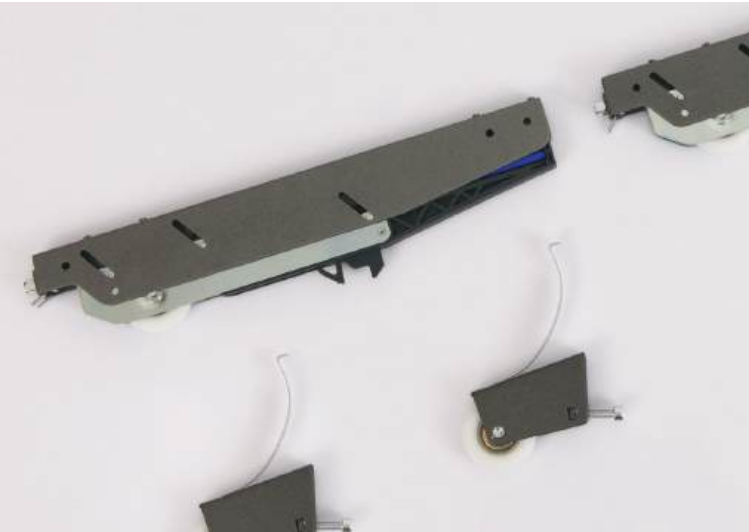

Bu serideki tüm ürünleri incelemek için QR kodu okutabilirsiniz.

You can search the QR code to see all the products in these series.

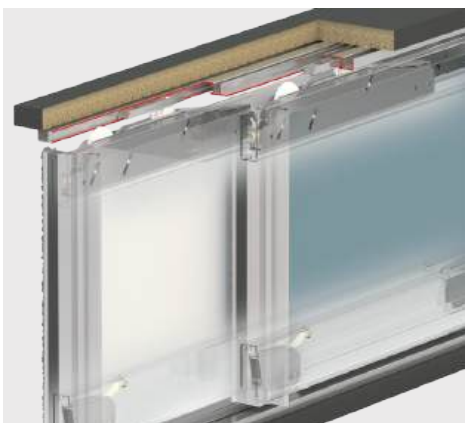

Rigel 1

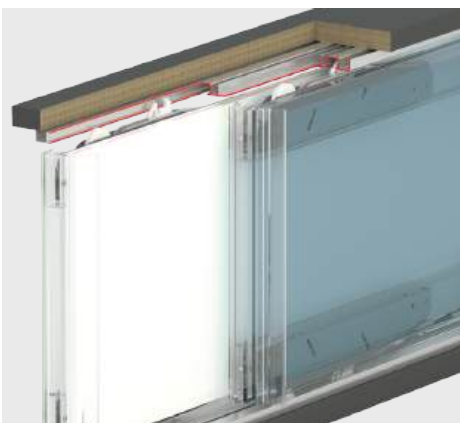

Rigel 2

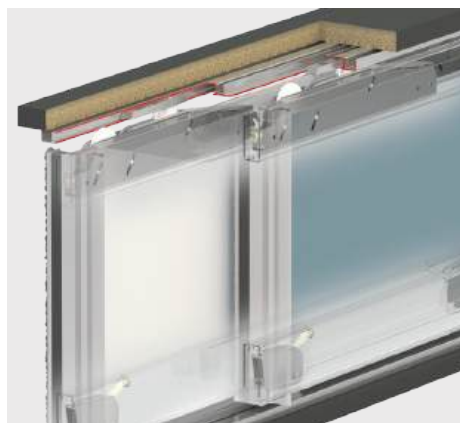

Rigel 3

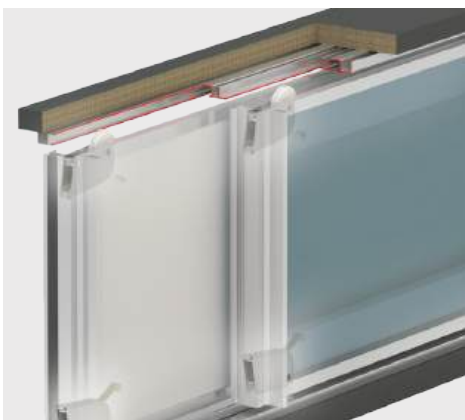

Rigel 4

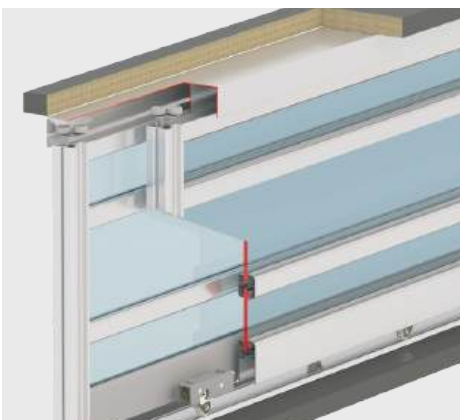

Rigel 1801

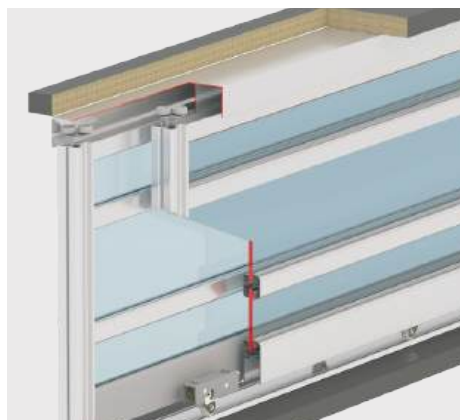

Rigel 1812

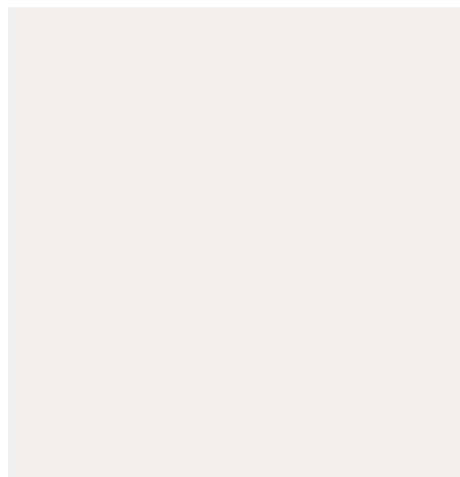
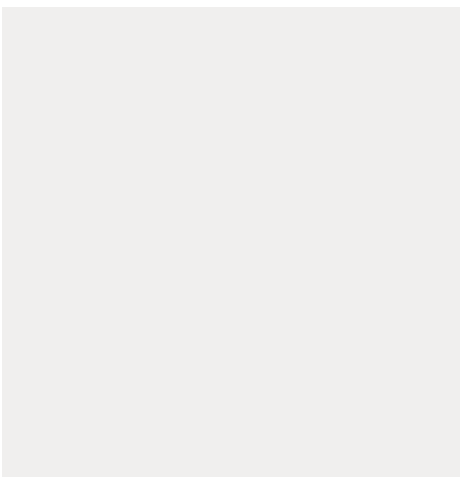
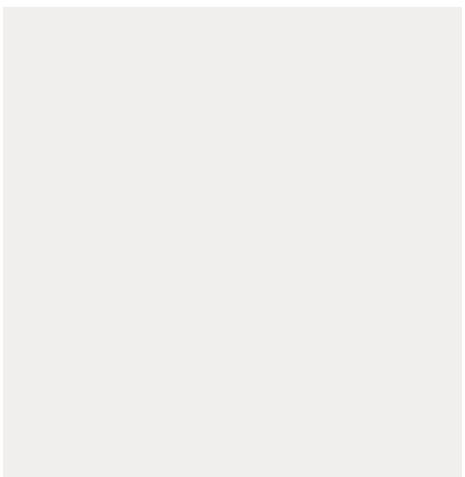
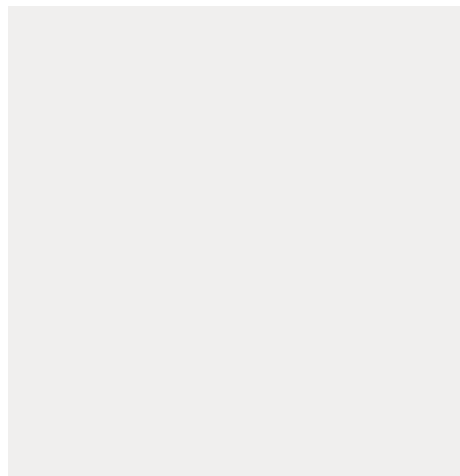
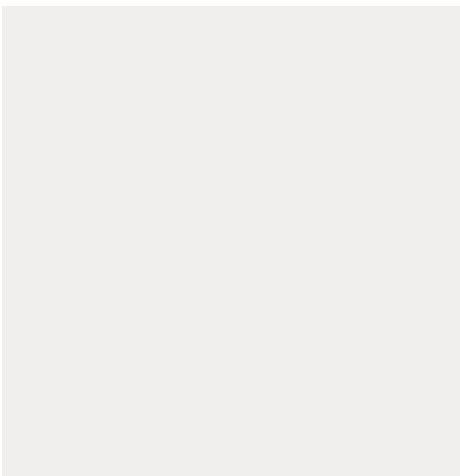
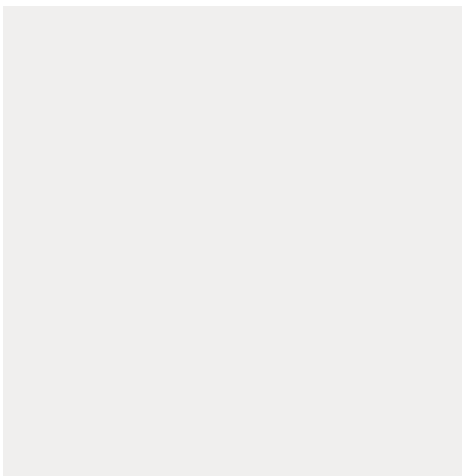

Rigel 1

50 KG SÜRME PANO SİSTEMİ • SLIDING PANEL SYSTEM

Yeni Ürün
New Product

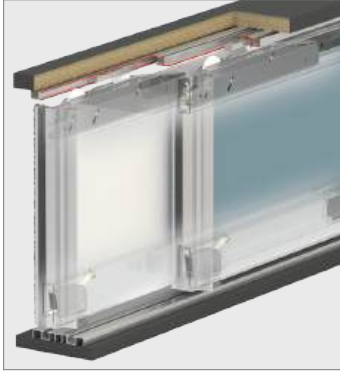

■ Yavaşlatıcı Alternatifi / Soft Closer Alternative

- Sistem üzerinde entegre yavaşlatıcı mevcuttur.
- The system has integrated soft closer.



■ 109-0251 1 Takım İçeriği / 1 Kit Includes

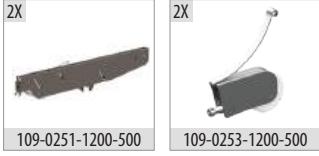

109-0251-1200-500



109-0253-1200-500



103-0220-1630-502

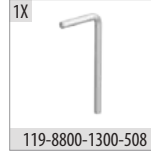

119-8800-1300-508

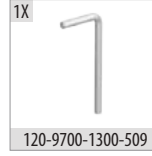

120-9700-1300-509



145-1810-1640 mt



145-1006-1673 mt

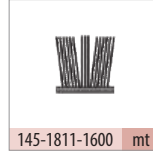

145-1811-1600 mt

■ Ray Profilleri / Rail Profiles

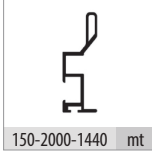

150-2000-1440 mt

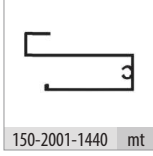

150-2001-1440 mt

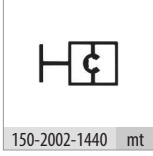

150-2002-1440 mt

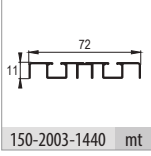

150-2003-1440 mt

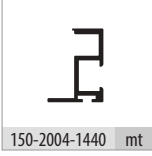

150-2004-1440 mt

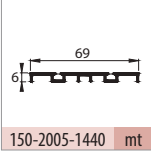

150-2005-1440 mt

■ Teknik Detay / Technical Detail

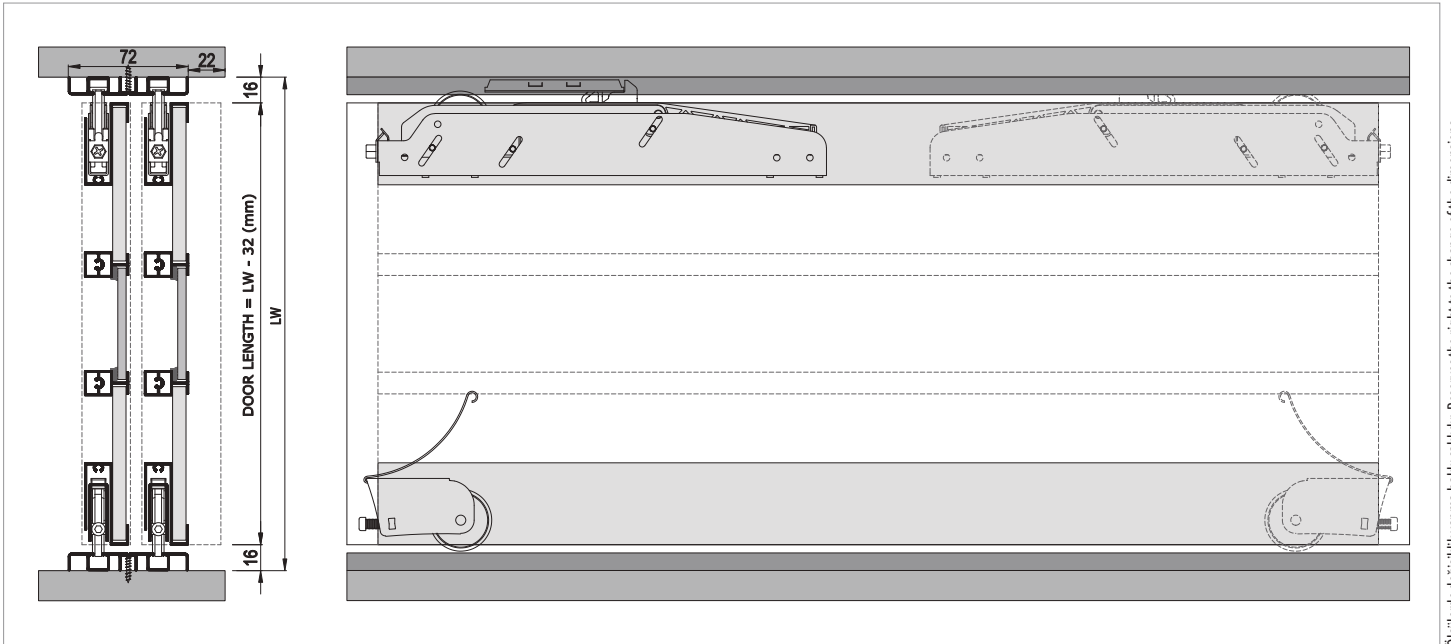

Ölçülerde değişiklik yapma hakkı saklıdır. Reserves the right to the change of the dimensions.

| Kod / Code No | Açıklama / Description | Renk / Colour | Birim / Unit | | | Profil mt. / Profiles mt. | Bağ / Bnd. |
|---------------|---|------------------------------|-----------------|-----|-------|---------------------------|------------|
| 109-0251-1200 | RIGEL 1 - 50 Kg Sürme Pano Sistemi / 50 Kg Sliding Panel System | Silver | 1 Kapak / 1 Kit | 24 | 720 | - - - | - |
| 145-1810-1640 | Kapama Fitolu / Closing Wick | Gri / Grey | mt. | 100 | 3.600 | - - - | - |
| 145-1006-1673 | Kapama Fitolu / Closing Wick | Gri / Grey | mt. | 100 | 3.600 | - - - | - |
| 145-1811-1600 | Kıl Fitolu / Ec-Wf Hair Wick | Gri / Grey | mt. | 300 | 7.200 | - - - | - |
| 150-2003-1440 | Alüminyum Ray Profili / Aluminium Rail Profile | Bronz Parlak / Bronze Bright | mt. | - | - | - - 3,0 | 10 ad/pcs |
| 150-2000-1440 | Alüminyum Kulp Profili / Aluminium Handle Profile | Bronz Parlak / Bronze Bright | mt. | - | - | - - 3,0 | 6 ad/pcs |
| 150-2001-1440 | Alüminyum Alt-Üst Kayıt Profili / Aluminium Bottom-Top Profile | Bronz Parlak / Bronze Bright | mt. | - | - | - - 3,0 | 6 ad/pcs |
| 150-2002-1440 | Alüminyum Orta Kayıt Profili / Aluminium Horizontal Central Profile | Bronz Parlak / Bronze Bright | mt. | - | - | - - 3,0 | 10 ad/pcs |
| 150-2004-1440 | Alüminyum Kulp Profili / Aluminium Handle Profile | Bronz Parlak / Bronze Bright | mt. | - | - | - - 3,0 | 6 ad/pcs |

Rigel 2

50 KG SÜRME PANO SİSTEMİ • SLIDING PANEL SYSTEM

Yeni Ürün
New Product

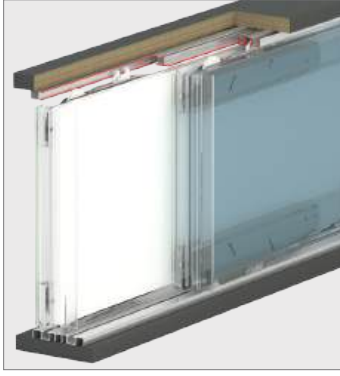

Yavaşlatıcı Alternatifi / Soft Closer Alternative

- Sistem üzerinde entegre yavaşlatıcı mevcuttur.
- The system has integrated soft closer.



109-0252 1 Takım İçeriği / 1 Kit Includes

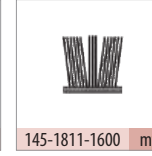
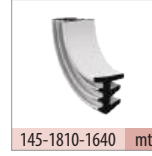
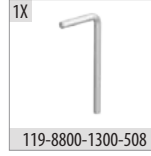

Alüminyum Fitilleri / Aluminium Wicks

Ray Profilleri / Rail Profiles

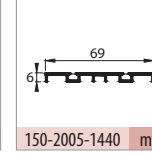
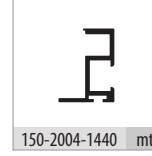
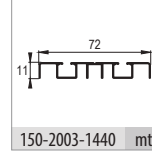
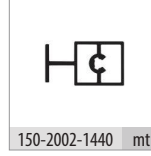
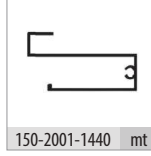
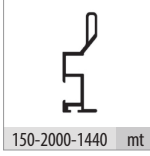

Teknik Detay / Technical Detail

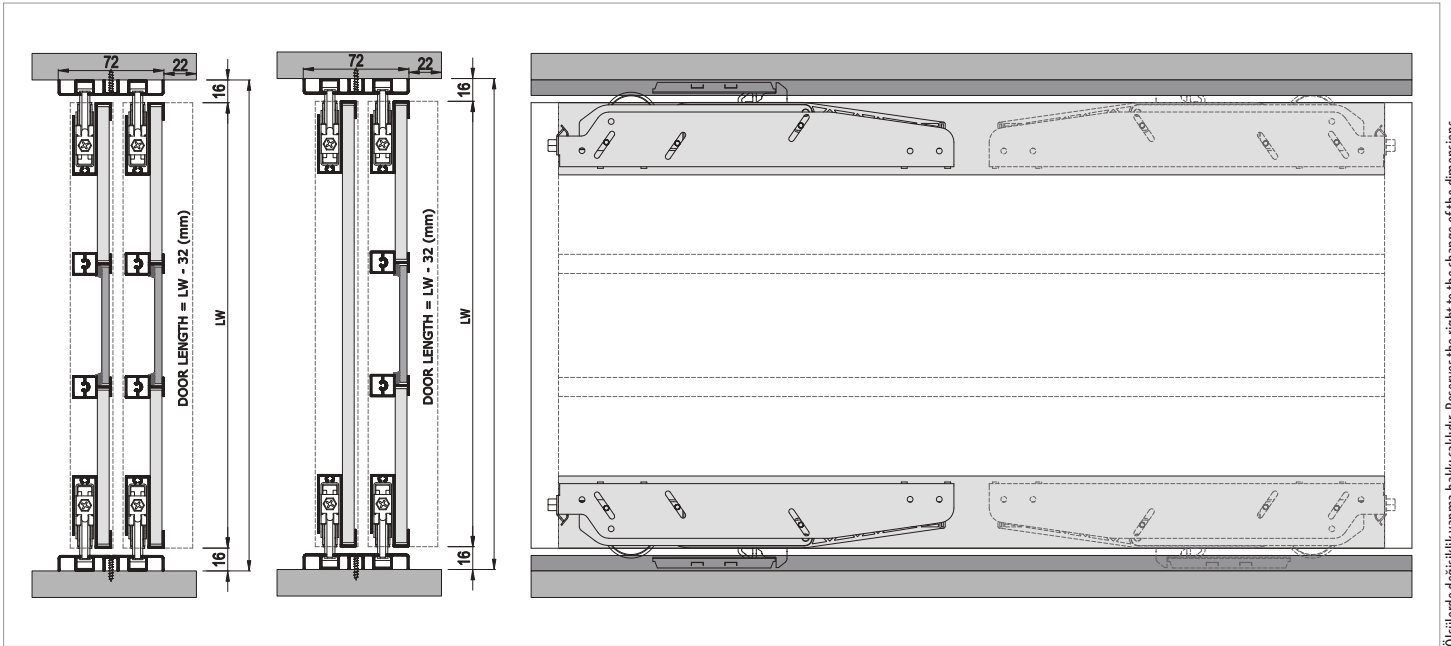

Ölçülerde değişiklik yapma hakkı saklıdır. Reserves the right to the change of the dimensions.

| Kod / Code No | Açıklama / Description | Renk / Colour | Birim / Unit | | | Profil mt. / Profiles mt. | Bağ / Bnd. |
|---------------|---|------------------------------|-----------------|-----|-------|---------------------------|---------------|
| 109-0252-1200 | RIGEL 2 - 50 Kg Sürme Pano Sistemi / 50 Kg Sliding Panel System | Silver | 1 Kapak / 1 Kit | 12 | 360 | - | - |
| 145-1810-1640 | Kapama Fitili / Closing Wick | Gri / Grey | mt. | 100 | 3.600 | - | - |
| 145-1006-1673 | Kapama Fitili / Closing Wick | Gri / Grey | mt. | 100 | 3.600 | - | - |
| 145-1811-1600 | Kıl Fitil / Ec-Wf Hair Wick | Gri / Grey | mt. | 300 | 7.200 | - | - |
| 150-2003-1440 | Alüminyum Ray Profili / Aluminium Rail Profile | Bronz Parlak / Bronze Bright | mt. | - | - | - | 3,0 10 ad/pcs |
| 150-2000-1440 | Alüminyum Kulp Profili / Aluminium Handle Profile | Bronz Parlak / Bronze Bright | mt. | - | - | - | 3,0 6 ad/pcs |
| 150-2001-1440 | Alüminyum Alt-Üst Kayıt Profili / Aluminium Bottom-Top Profile | Bronz Parlak / Bronze Bright | mt. | - | - | - | 3,0 6 ad/pcs |
| 150-2002-1440 | Alüminyum Orta Kayıt Profili / Aluminium Horizontal Central Profile | Bronz Parlak / Bronze Bright | mt. | - | - | - | 3,0 10 ad/pcs |
| 150-2004-1440 | Alüminyum Kulp Profili / Aluminium Handle Profile | Bronz Parlak / Bronze Bright | mt. | - | - | - | 3,0 6 ad/pcs |

Rigel 3

50 KG SÜRME PANO SİSTEMİ • SLIDING PANEL SYSTEM

Yeni Ürün
New Product

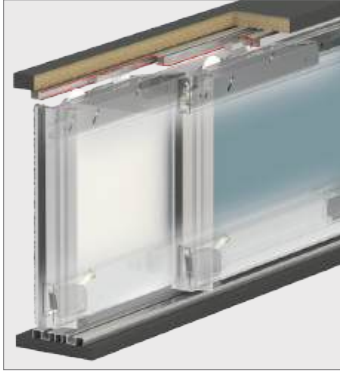

■ Yavaşlatıcı Alternatifi / Soft Closer Alternative

- Sistem üzerinde entegre yavaşlatıcı mevcuttur.
- The system has integrated soft closer.



■ 109-0253 1 Adet İçeriği / 1 Pcs. Includes



109-0251-1200-500



103-0220-1630-502



119-8800-1300-508



145-1810-1640 mt



145-1006-1673 mt

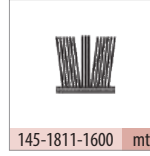

145-1811-1600 mt

■ Ray Profilleri / Rail Profiles

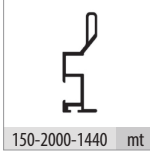

150-2000-1440 mt

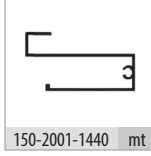

150-2001-1440 mt

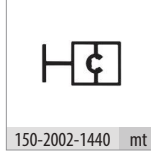

150-2002-1440 mt

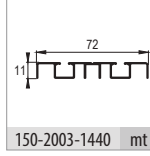

150-2003-1440 mt

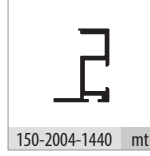

150-2004-1440 mt

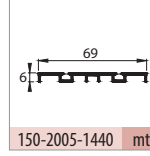

150-2005-1440 mt

■ Teknik Detay / Technical Detail

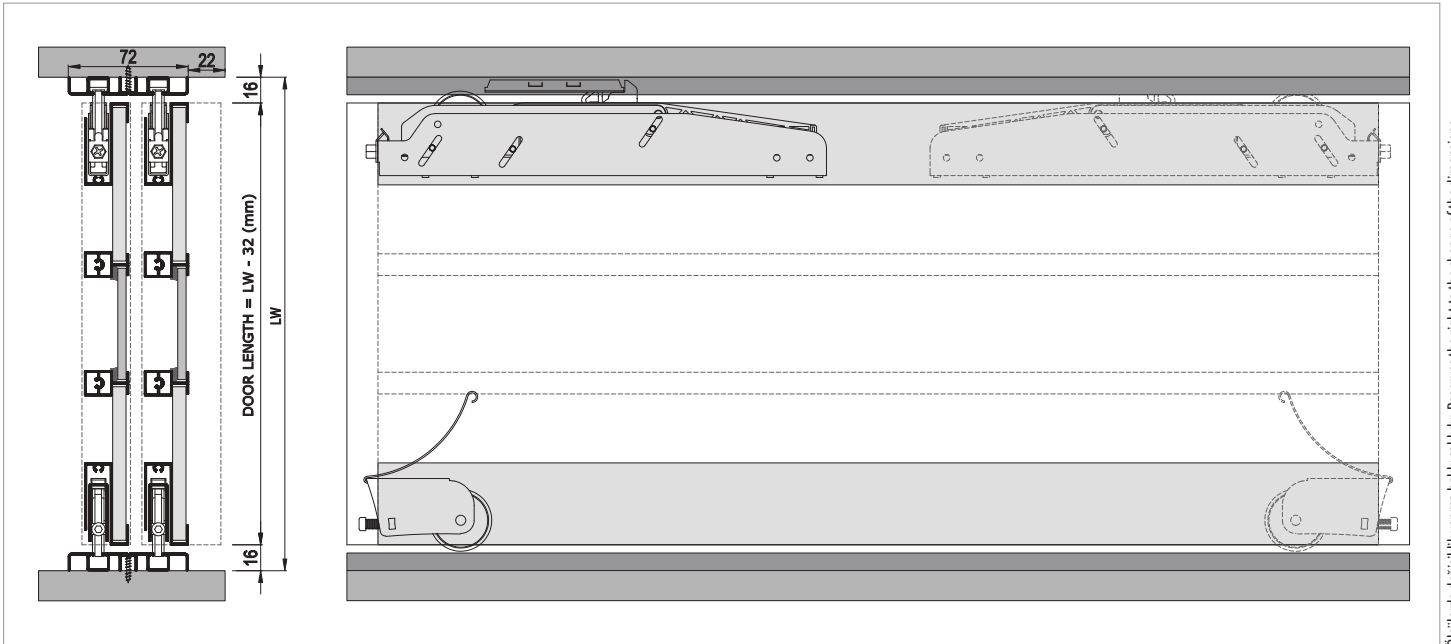

Ölçülerde değişiklik yapma hakkı saklıdır. Reserves the right to the change of the dimensions.

| Kod / Code No | Açıklama / Description | Renk / Colour | Birim / Unit | | | Profil mt. / Profiles mt. | Bağ / Bnd. |
|---------------|---|------------------------------|----------------|-----|-------|---------------------------|------------|
| 109-0253-1200 | RIGEL 3 - 50 Kg Sürme Pano Sistemi / 50 Kg Sliding Panel System | Silver | 1 Adet / 1 Pcs | 40 | 1.280 | - - - | - |
| 145-1810-1640 | Kapama Fitolu / Closing Wick | Gri / Grey | mt. | 100 | 3.600 | - - - | - |
| 145-1006-1673 | Kapama Fitolu / Closing Wick | Gri / Grey | mt. | 100 | 3.600 | - - - | - |
| 145-1811-1600 | Kıl Fitolu / Ec-Wf Hair Wick | Gri / Grey | mt. | 300 | 7.200 | - - - | - |
| 150-2003-1440 | Alüminyum Ray Profili / Aluminium Rail Profile | Bronz Parlak / Bronze Bright | mt. | - | - | - - 3,0 | 10 ad/pcs |
| 150-2000-1440 | Alüminyum Kulp Profili / Aluminium Handle Profile | Bronz Parlak / Bronze Bright | mt. | - | - | - - 3,0 | 6 ad/pcs |
| 150-2001-1440 | Alüminyum Alt-Üst Kayıt Profili / Aluminium Bottom-Top Profile | Bronz Parlak / Bronze Bright | mt. | - | - | - - 3,0 | 6 ad/pcs |
| 150-2002-1440 | Alüminyum Orta Kayıt Profili / Aluminium Horizontal Central Profile | Bronz Parlak / Bronze Bright | mt. | - | - | - - 3,0 | 10 ad/pcs |
| 150-2004-1440 | Alüminyum Kulp Profili / Aluminium Handle Profile | Bronz Parlak / Bronze Bright | mt. | - | - | - - 3,0 | 6 ad/pcs |

Rigel 4

50 KG SÜRME PANO SİSTEMİ • SLIDING PANEL SYSTEM

Yeni Ürün
New Product

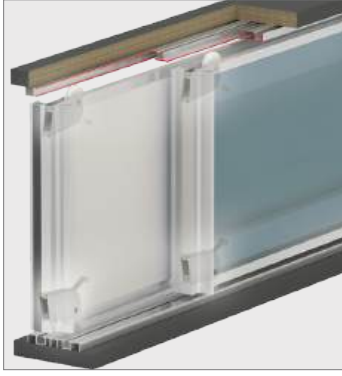

109-0254 1 Takım İçeriği / 1 Kit Includes

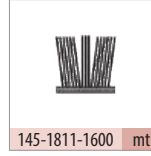
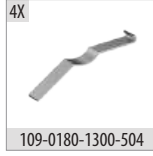
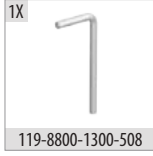

Ray Profilleri / Rail Profiles

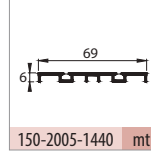
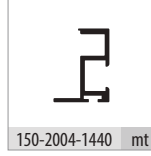
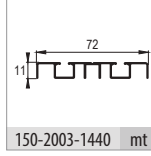
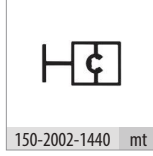
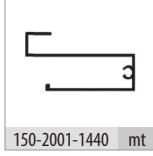
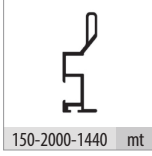

Teknik Detay / Technical Detail

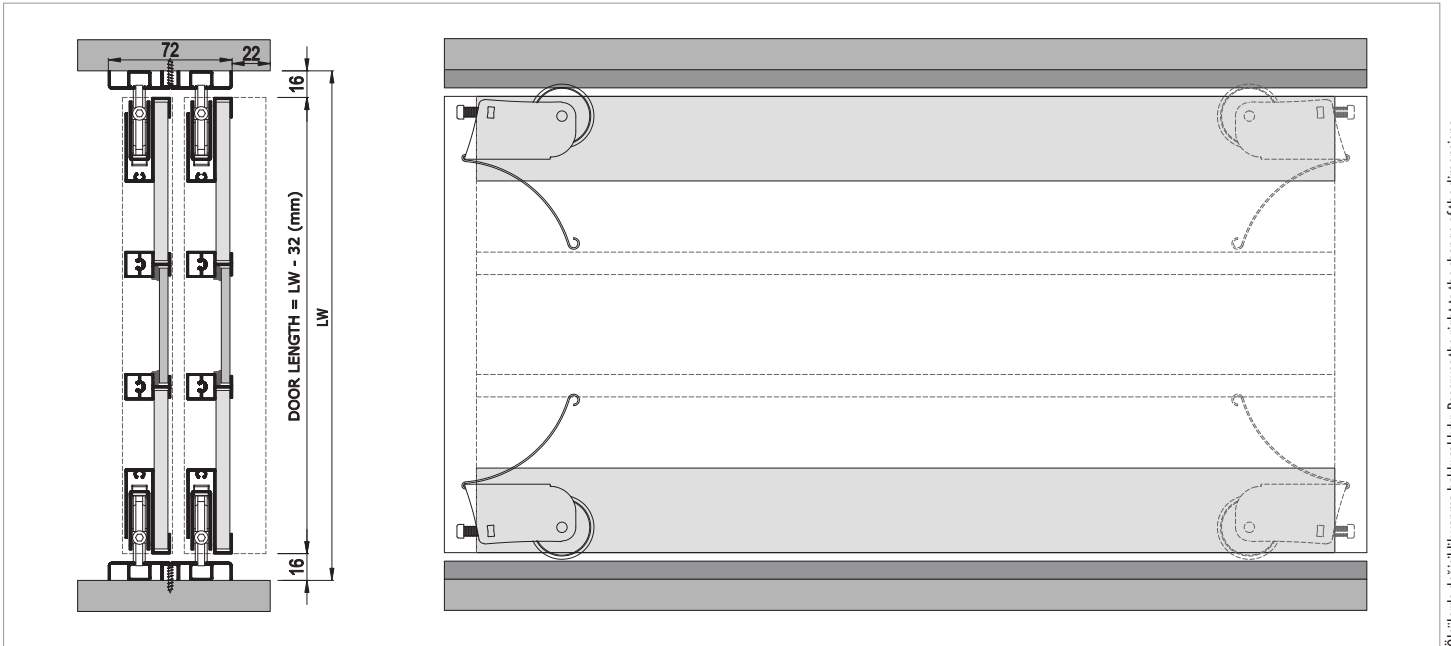

Ölçülerde değişiklik yapma hakkı saklıdır. Reserves the right to the change of the dimensions.

| Kod / Code No | Açıklama / Description | Renk / Colour | Birim / Unit | | | Profil mt. / Profiles mt. | Bağ / Bnd. |
|---------------|---|------------------------------|-----------------|-----|-------|---------------------------|------------|
| 109-0254-1200 | RIGEL 4 - 50 Kg Sürme Pano Sistemi / 50 Kg Sliding Panel System | Silver | 1 Takım / 1 Kit | 32 | 1.024 | - - - | - |
| 145-1810-1640 | Kapama Fitolu / Closing Wick | Gri / Grey | mt. | 100 | 3.600 | - - - | - |
| 145-1006-1673 | Kapama Fitolu / Closing Wick | Gri / Grey | mt. | 100 | 3.600 | - - - | - |
| 145-1811-1600 | Kıl Fitolu / Ec-Wf Hair Wick | Gri / Grey | mt. | 300 | 7.200 | - - - | - |
| 150-2003-1440 | Alüminyum Ray Profili / Aluminium Rail Profile | Bronz Parlak / Bronze Bright | mt. | - | - | - - 3,0 | 10 ad/pcs |
| 150-2000-1440 | Alüminyum Kulp Profili / Aluminium Handle Profile | Bronz Parlak / Bronze Bright | mt. | - | - | - - 3,0 | 6 ad/pcs |
| 150-2001-1440 | Alüminyum Alt-Üst Kayıt Profili / Aluminium Bottom-Top Profile | Bronz Parlak / Bronze Bright | mt. | - | - | - - 3,0 | 6 ad/pcs |
| 150-2002-1440 | Alüminyum Orta Kayıt Profili / Aluminium Horizontal Central Profile | Bronz Parlak / Bronze Bright | mt. | - | - | - - 3,0 | 10 ad/pcs |
| 150-2004-1440 | Alüminyum Kulp Profili / Aluminium Handle Profile | Bronz Parlak / Bronze Bright | mt. | - | - | - - 3,0 | 6 ad/pcs |

Rigel Alüminyum Kapak Sistemi

ALUMINIUM FULL FRAME SYSTEM

Yeni Ürün
New Product

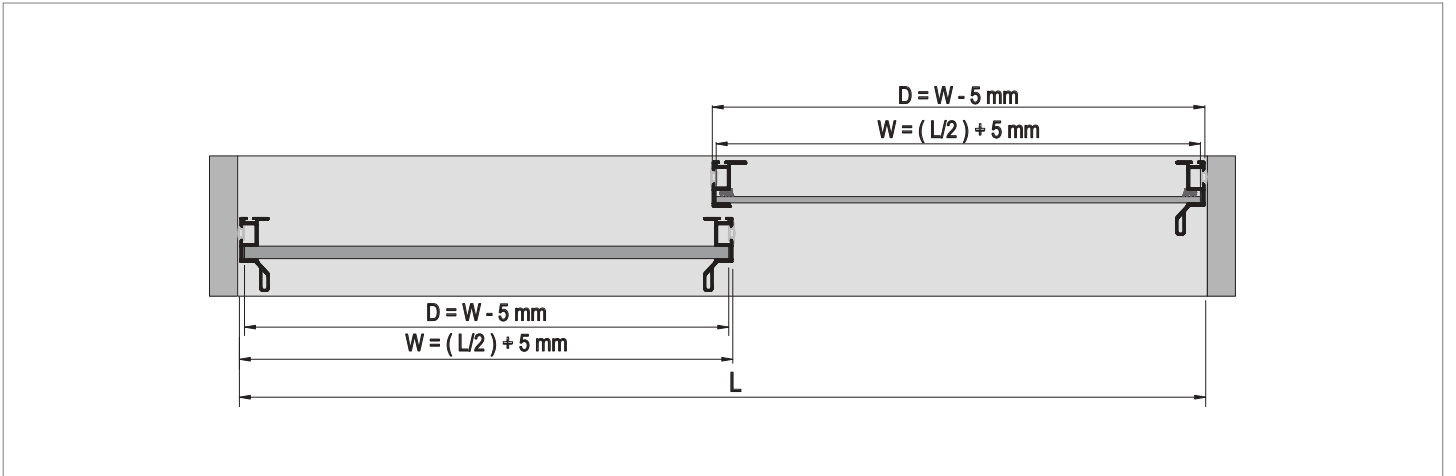
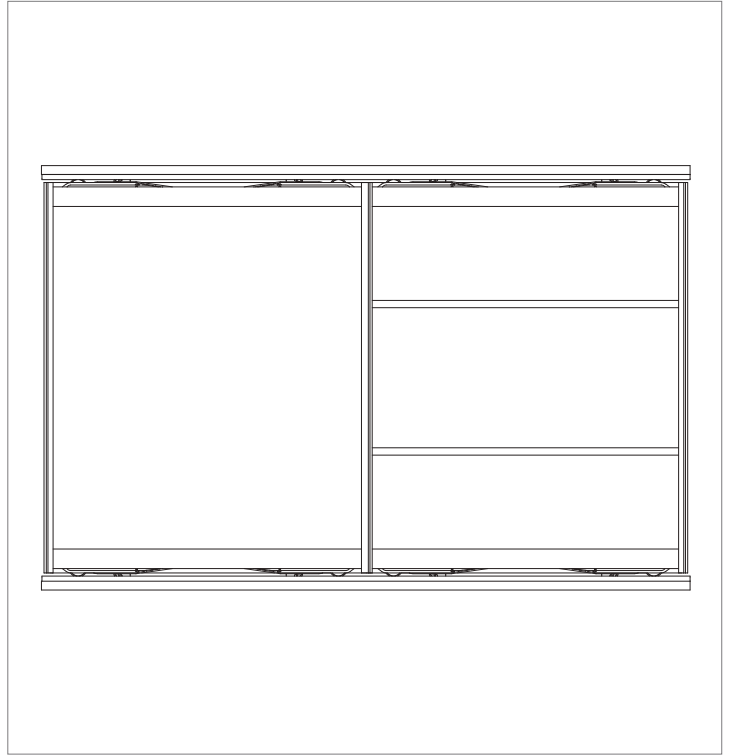
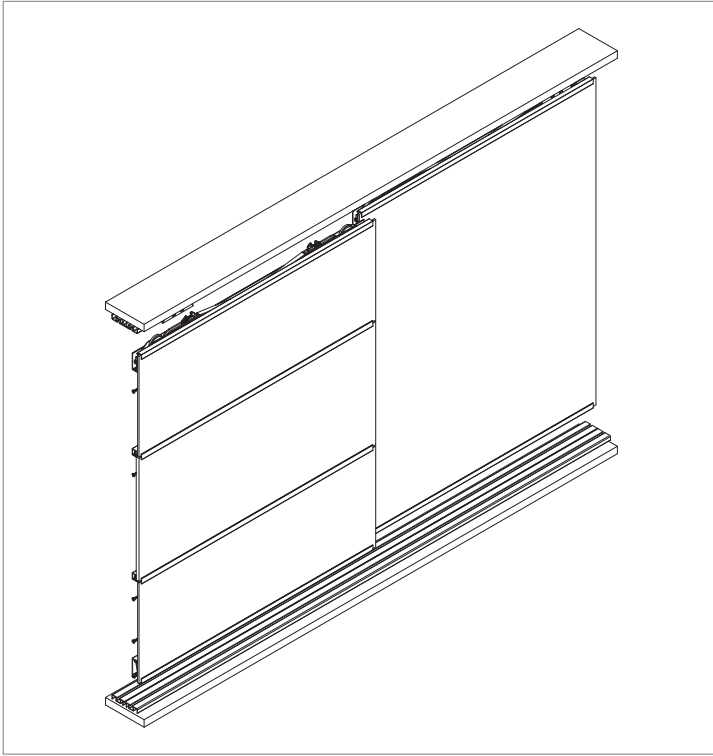
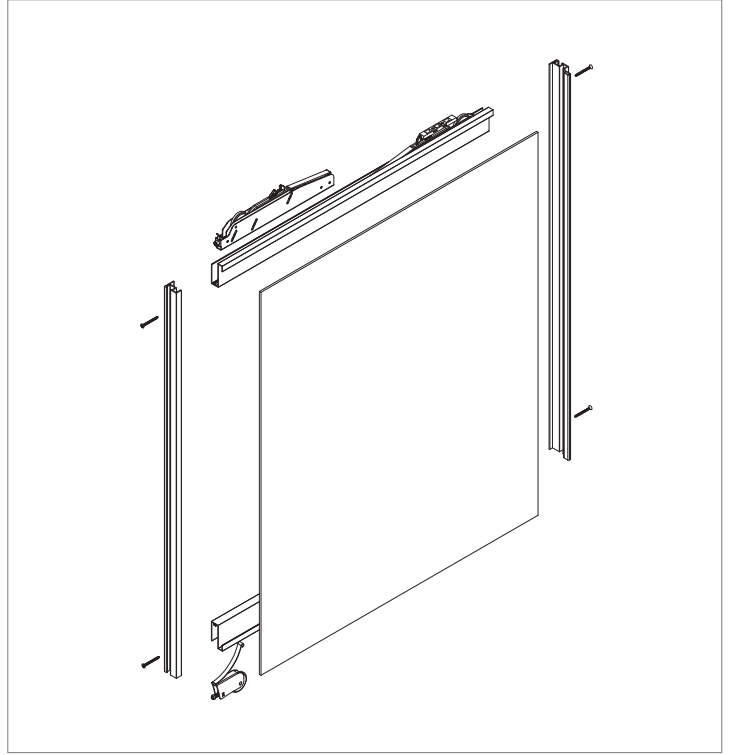
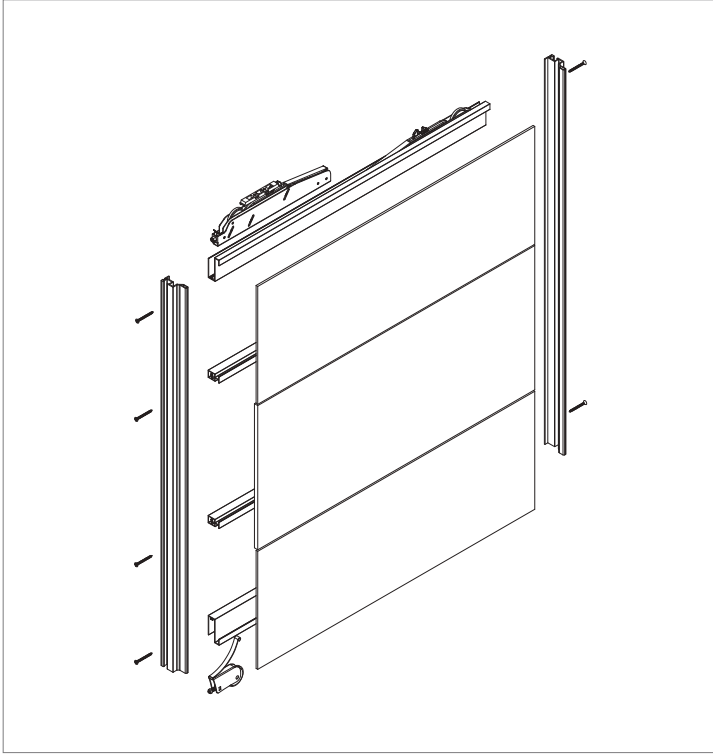

Rigel 1801

60 KG ALÜMİNYUM RAYLI PANO SİSTEMİ • SLIDING ALUMINIUM PANEL/DOOR SYSTEM

0180

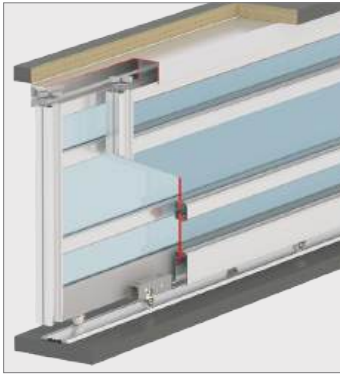

Yavaşlatıcı Alternatifi / Soft Closer Alternative

117-6700-1600 <<>> 117-6922-1610 <<>> 117-6921-1600 <<>>



109-1801 1 Takım İçeriği / 1 Kit Includes



109-1812 1 Takım İçeriği / 1 Kit Includes

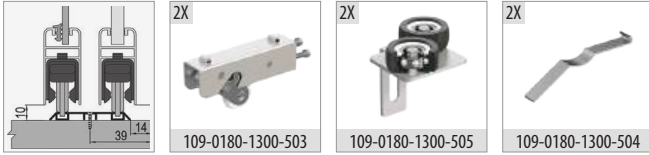

Alüminyum Fitilleri / Aluminium Wicks



Ray Profilleri / Rail Profiles

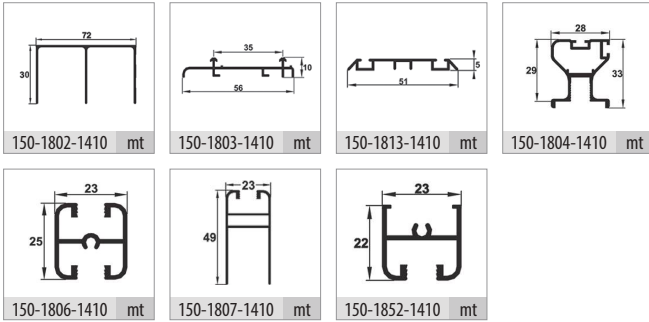

Teknik Detay / Technical Detail

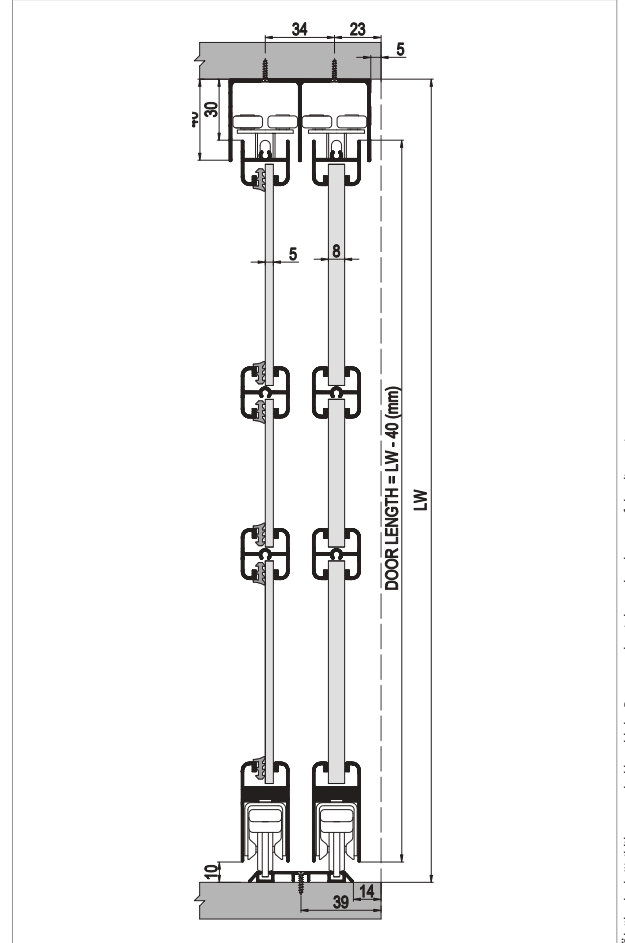

Ölçülerde değişiklik yapıma hakkı saklıdır. Reserves the right to the change of the dimensions.

| Kod / Code No | Açıklama / Description | Renk / Colour | Birim / Unit | | | Profil mt. / Profiles mt. | Bağ / Bnd. |
|---------------|---|------------------------|-----------------|-----|-------|---------------------------|------------|
| 109-1801-1300 | 60 Kg. Pano Dişi Teker Mekanizması / Panel System Beta | Galvaniz / Galvanized | 1 Kapak / 1 Kit | 48 | 1.152 | - | - |
| 109-1812-1300 | 60 Kg. Pano Erkek Teker Mekanizması / Panel System Gama | Galvaniz / Galvanized | 1 Kapak / 1 Kit | 48 | 1.152 | - | - |
| 145-1808-1600 | Kapama Fitolu / Closing Wick | Gri / Grey | mt. | 100 | 3.600 | - | - |
| 145-1810-1640 | Cam Fitolu / Glass Wick | Şeffaf / Transparan | mt. | 100 | 3.600 | - | - |
| 145-1811-1600 | Kıl Fitolu / Ec-Wf Hair Wick | Gri / Grey | mt. | 300 | 7.200 | - | - |
| 150-1802-1410 | Alüminyum Üst Ray Profili / Aluminium Top Rail Profile | Eloksal / Mat Anodized | mt. | - | - | - | 6,0 |
| 150-1803-1410 | Alüminyum Alt Ray Profili / Aluminium Bottom Rail Profile | Eloksal / Mat Anodized | mt. | - | - | - | 6,0 |
| 150-1813-1410 | Alüminyum Alt Ray Profili / Aluminium Bottom Rail Profile | Eloksal / Mat Anodized | mt. | - | - | - | 6,0 |
| 150-1804-1410 | Alüminyum Kulp Profili / Aluminium Handle Profile | Eloksal / Mat Anodized | mt. | - | - | - | 6,0 |
| 150-1806-1410 | Alüminyum Orta Kayıt Profili / Aluminium Horizontal Central Profile | Eloksal / Mat Anodized | mt. | - | - | - | 6,0 |
| 150-1807-1410 | Alüminyum Kapama Profili / Aluminium Closure Profile | Eloksal / Mat Anodized | mt. | - | - | - | 6,0 |
| 150-1852-1410 | Alüminyum Üst Kayıt Profili / Aluminium Top Entry Profile | Eloksal / Mat Anodized | mt. | - | - | - | 6,0 |

ALBATUR
produces quality

Group 110

TvSlide®

Sürme Tv Ünite Serisi

Sliding Tv Unit Series



Bu serideki tüm ürünleri incelemek için QR kodu okutabilirsiniz.

You can search the QR code to see all the products in these series.

TvSlide 5100

45 KG TV ÜNİTESİ SÜRME KAPAK SİSTEMİ • TV UNIT SLIDING DOOR SYSTEM



Yavaşlatıcı Alternatifi / Soft Closer Alternative

117-6901-1610 <<>> 117-6950-1610 <<>>



110-5100 1 Takım İçeriği / 1 Kit Includes



Ray Profilleri / Rail Profiles

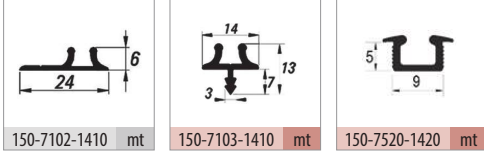

Opsiyonel Aksesuar / Optional Accessories



Teknik Detay / Technical Detail

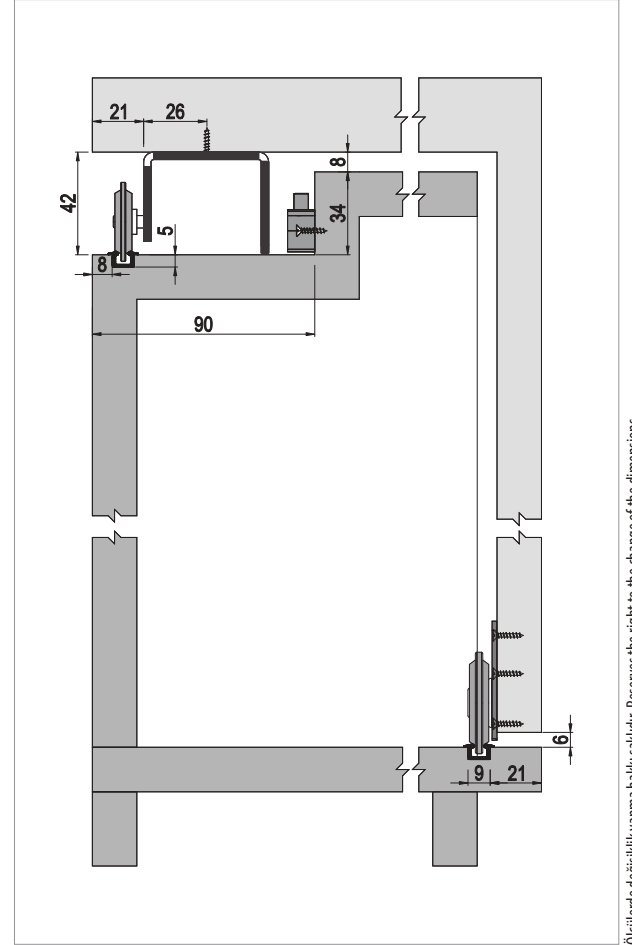

Ölçülerde değişiklik yapma hakkı saklıdır. Reserves the right to the change of the dimensions.

| Kod / Code No | Açıklama / Description | Renk / Colour | Birim / Unit | | | Profil mt. / Profiles mt. | Bağ / Bnd. |
|---------------|--|------------------------|-----------------|-------|---------|---------------------------|------------|
| 110-5100-1300 | 45 Kg TV Ünitesi Sürme Kapak Sistemi / TV Unit Sliding Door System | Galvaniz / Galvanized | 1 Kapak / 1 Kit | 12 | 360 | - - - | - |
| 117-1011-1600 | Plastik Ray Tapası / Plastic Rail Cap | Gri / Grey | 1 Adet / 1 Pcs | 1.000 | 120.000 | - - - | - |
| 150-7102-1410 | Alüminyum Ray Profili / Aluminium Rail Profile | Eloksal / Mat Anodized | mt. | - | - | - - 3,0 | 20 ad/pcs |
| 150-7103-1410 | Alüminyum Ray Profili / Aluminium Rail Profile | Eloksal / Mat Anodized | mt. | - | - | - - 3,0 | 30 ad/pcs |
| 150-7520-1410 | Alüminyum Ray Profili / Aluminium Rail Profile | Eloksal / Mat Anodized | mt. | - | - | - - 3,0 | 30 ad/pcs |

Group 117

Softline[®]

Yavaşlatıcı Serisi
Soft Closers Series

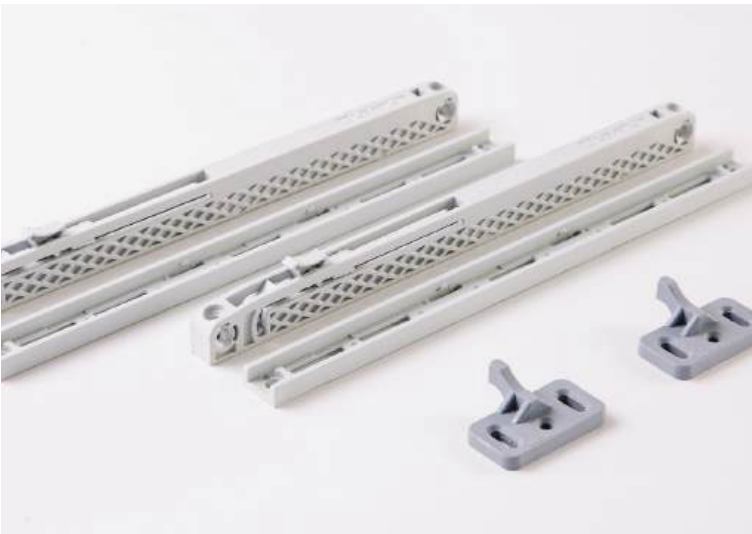

Bu serideki tüm ürünleri incelemek için
QR kodu okutabilirsiniz.

You can search the QR code to see all the
products in these series.



Softline **6710**



Softline **6711**



Softline **6666**



Softline **6740**



Softline **6940**



Softline **6950**



Softline **6970**



Softline **6800**



Softline **6810**



Softline **6942**



Softline **6901**



Softline **6820**



Softline **6990**



Softline **6700**



Softline **6922**



Softline **6921**



Softline **6959**



Neden yavaşlatıcı kullanılmalı?

Daha az gürültü

Yavaşlatma mekanizmalı kayar kapı ve kapaklar, yüksek konsantrasyon gerektiren mekanlarda istenmeyen sesleri önler ve gürültüsüz bir ortam sağlar.

Why soft closer should be used?

Less Noise

Sliding doors and covers with soft closer mechanisms prevent unwanted sounds and provide a noiseless environment in places that require high concentration.



Yüksek güvenlik

Yavaşlatma mekanizması, özellikle küçük çocukların, yaşlı ya da engellilerin olduğu ortamlarda parmakların kapı ve duvar veya kapak ve yan panel arasına sıkışma riskini engeller. Otomatik frenleme sistemi ve yavaş kapanma özelliği kapının veya kapağın çarparak kapanmasını engellediği için yüksek güvenlik sağlar.

High Security

The Soft closer mechanism prevents the risk of fingers being caught between the door and the wall or the door and the side panel, especially in the presence of small children, the elderly or the disabled. The automatic braking system and slow closing feature provide high security as it prevents the door or cover from slamming shut.



Düşük maliyet, yüksek verim

Albatur yavaşlatıcı sistemleri, özellikle farklı tipte kayar kapı ve kapaklar için tasarlanmış ve uygulanmış ürünlerdir. Farklı kapı ve kayar kapı tiplerinin bir çoğu vidalanarak kolayca takılabilen Albatur yavaşlatma sistemleri ile yüksek maliyet gerektirmeden donatılabilir.

Low cost maximum efficiency

Albatur soft closer systems are designed and applied especially different types of sliding doors and covers. Most of the different door and sliding door types can be equipped with Albatur soft closer systems that can be easily screwed and without requiring high cost.



Malzeme dostu

Sürgülü kapı ve kapakların sertçe kapanması, mekanizmanın işlemlerini sağlayan makaraların, rayların, kapı ve kapak kanatlarının, profillerin, kasa ve pervazların aşırı yıpranmasına neden olur. Yavaşlatma mekanizması kayar kapı ve kapakların kasaya çarparak yıpranmasını önleyerek uzun yıllar güvenle kullanılmasını sağlar.

Material friendly

Fast closing of sliding doors and covers causes excessive wear of rollers, rails, door and cover wings, profiles, casing and moldings that enable the mechanism to work. The soft closing mechanism prevents the sliding doors and covers from being worn out by hitting the case, and ensures that they can be used safely for many years.

Softline 6710

100 KG YAVAŞLATICI SİSTEM • 100 KG SOFT CLOSER SYSTEM

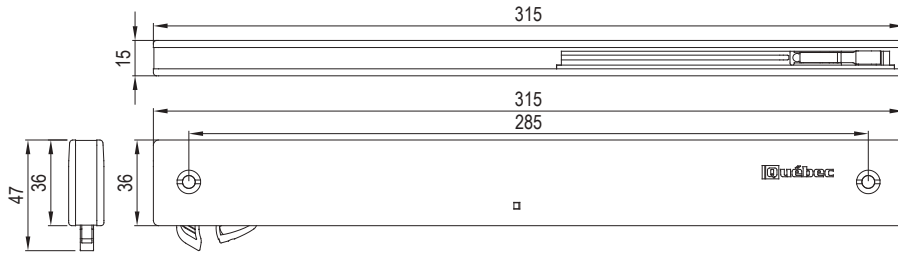

| Kod / Code No | Açıklama / Description | Renk / Colour | Birim / Unit | | |
|---------------|--|---------------|-----------------|----|-----|
| 117-6710-1610 | 100 Kg Yavaşlatıcı Sistem / 100 Kg Soft Closer | Gri / Grey | 1 Takım / 1 Kit | 20 | 480 |

Softline 6711

100 KG YAVAŞLATICI SİSTEM • 100 KG SOFT CLOSER SYSTEM

Yeni Ürün
New Product

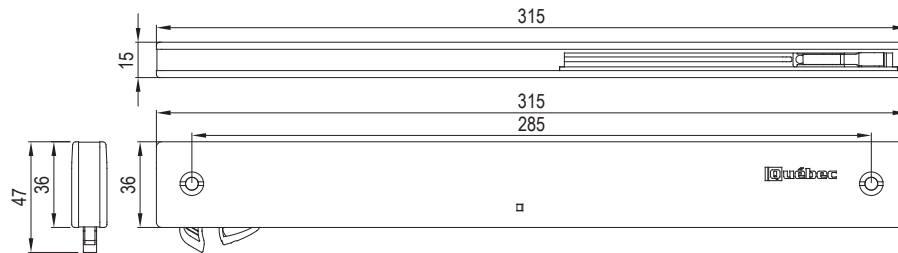
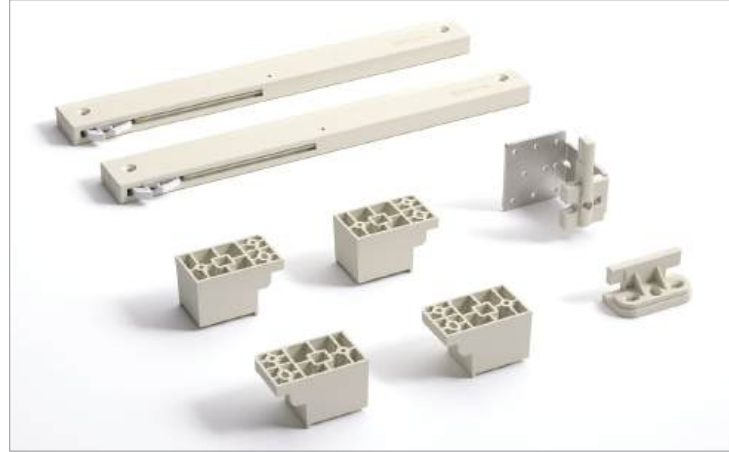

| Kod / Code No | Açıklama / Description | Renk / Colour | Birim / Unit | | |
|---------------|---|---------------|-----------------|----|-----|
| 117-6711-1610 | 100 Kg Yavaşlatıcı Mekanizma / 100 Kg Soft Closer Mechanism | Gri / Grey | 1 Takım / 1 Kit | 24 | 576 |

Softline 6666

60 KG YAVAŞLATICI SİSTEM • 60 KG SOFT CLOSER SYSTEM

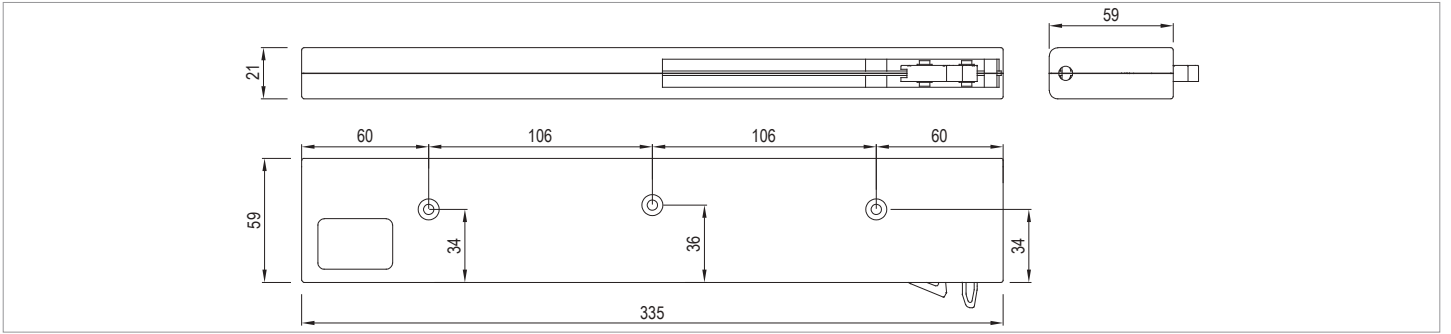

| Kod / Code No | Açıklama / Description | Renk / Colour | Birim / Unit | | |
|---------------|---|---------------|-----------------|----|-----|
| 117-6666-1610 | 60 Kg Yavaşlatıcı Mekanizma / 60 Kg Soft Closer Mechanism | Gri / Grey | 1 Takım / 1 Kit | 30 | 360 |

Softline 6740

60 KG YAVAŞLATICI SİSTEM • 60 KG SOFT CLOSER SYSTEM

Yeni Ürün
New Product

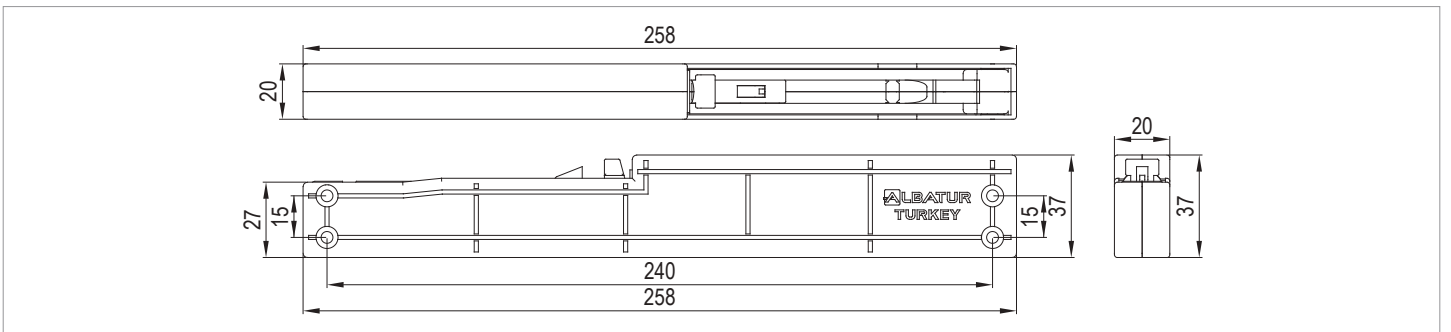

| Kod / Code No | Açıklama / Description | Renk / Colour | Birim / Unit | | |
|---------------|---|---------------|-----------------|----|-------|
| 117-6740-1610 | 60 Kg Yavaşlatıcı Mekanizma / 60 Kg Soft Closer Mechanism | Gri / Grey | 1 Adet / 1 Pcs. | 60 | 1.250 |

Softline 6940

40 KG YAVAŞLATICI SİSTEM • 40 KG SOFT CLOSER SYSTEM

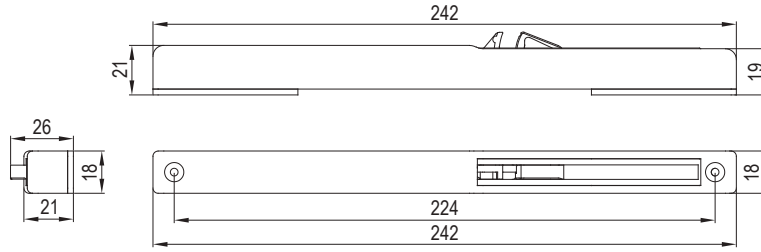

| Kod / Code No | Açıklama / Description | Renk / Colour | Birim / Unit | | |
|---------------|---|---------------|-----------------|----|-------|
| 117-6940-1600 | 40 Kg Yavaşlatıcı Mekanizma / 40 Kg Soft Closer Mechanism | Gri / Grey | 1 Takım / 1 Kit | 50 | 1.250 |

Softline 6950

50 KG YAVAŞLATICI SİSTEM • 50 KG SOFT CLOSER SYSTEM

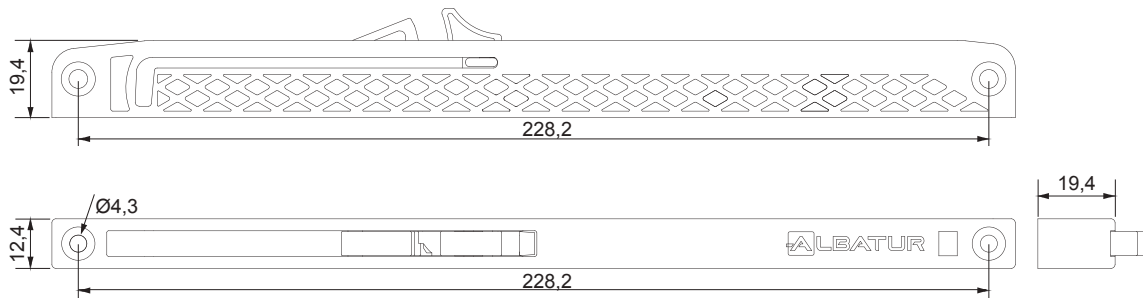

| Kod / Code No | Açıklama / Description | Renk / Colour | Birim / Unit | | |
|---------------|---|---------------|-----------------|----|-------|
| 117-6950-1610 | 50 Kg Yavaşlatıcı Mekanizma / 50 Kg Soft Closer Mechanism | Gri / Grey | 1 Takım / 1 Kit | 50 | 1.250 |

Softline 6970

70 KG YAVAŞLATICI SİSTEM • 70 KG SOFT CLOSER SYSTEM

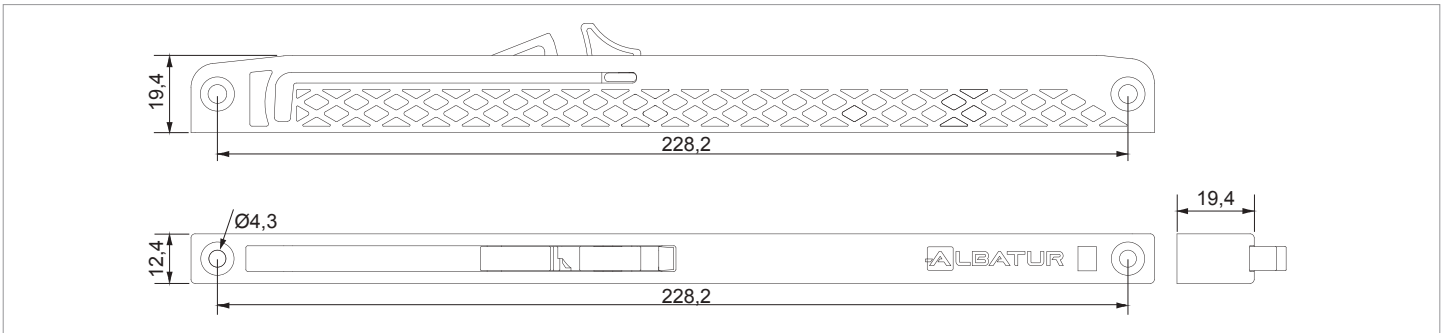

| Kod / Code No | Açıklama / Description | Renk / Colour | Birim / Unit | | |
|---------------|---|---------------|-----------------|----|-------|
| 117-6970-1610 | 70 Kg Yavaşlatıcı Mekanizma / 70 Kg Soft Closer Mechanism | Gri / Grey | 1 Takım / 1 Kit | 50 | 1.250 |

Softline 6800

80 KG YAVAŞLATICI SİSTEM • 80 KG SOFT CLOSER SYSTEM

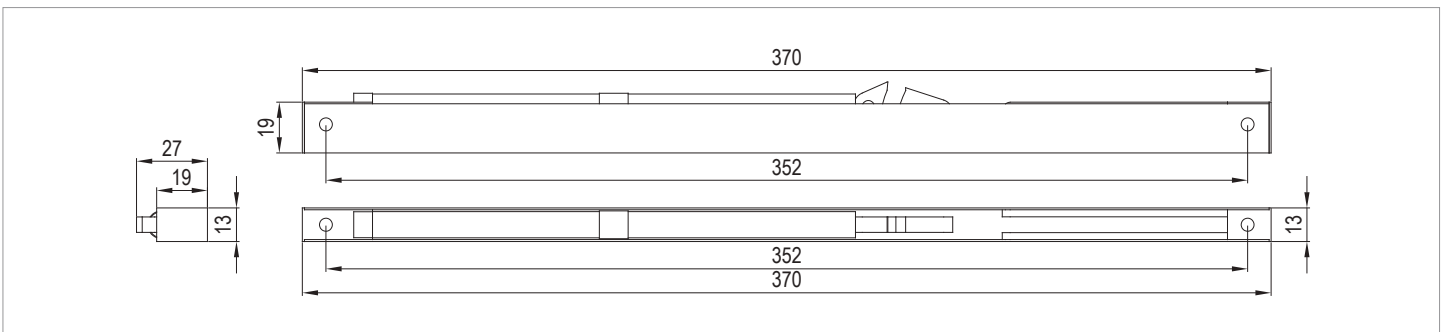

| Kod / Code No | Açıklama / Description | Renk / Colour | Birim / Unit | | |
|---------------|---|-----------------------|-----------------|----|-----|
| 117-6800-1300 | 80 Kg Yavaşlatıcı Mekanizma / 80 Kg Soft Closer Mechanism | Galvaniz / Galvanized | 1 Takım / 1 Kit | 24 | 576 |

Softline 6810

80 KG YAVAŞLATICI SİSTEM • 80 KG SOFT CLOSER SYSTEM

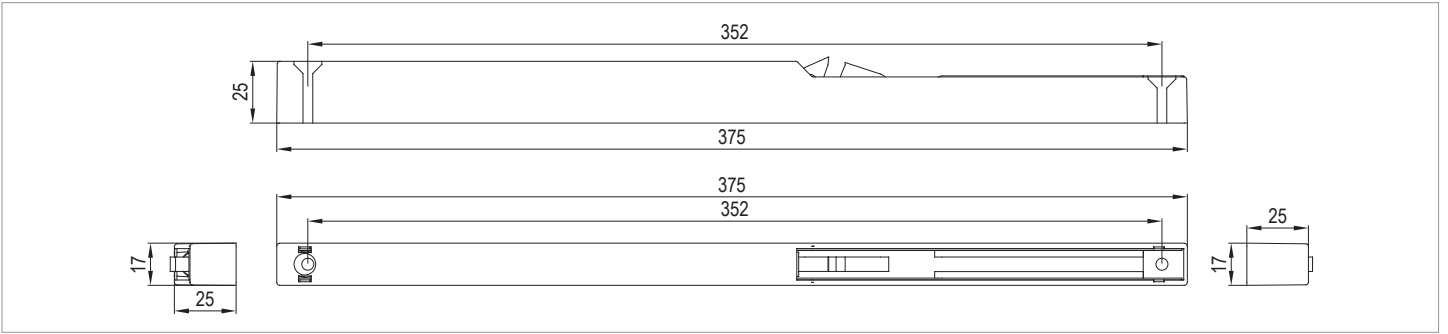

| Kod / Code No | Açıklama / Description | Renk / Colour | Birim / Unit | | |
|---------------|---|---------------|-----------------|----|-----|
| 117-6810-1600 | 80 Kg Yavaşlatıcı Mekanizma / 80 Kg Soft Closer Mechanism | Gri / Grey | 1 Takım / 1 Kit | 24 | 576 |

Softline 6942

50 KG YAVAŞLATICI SİSTEM • 50 KG SOFT CLOSER SYSTEM

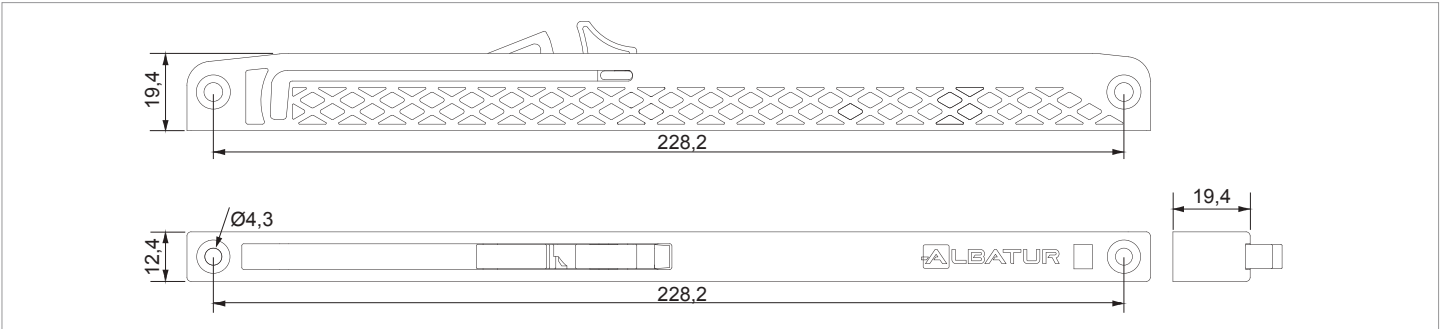

| Kod / Code No | Açıklama / Description | Renk / Colour | Birim / Unit | | |
|---------------|---|---------------|-----------------|----|-------|
| 117-6942-1610 | 50 Kg Yavaşlatıcı Mekanizma / 50 Kg Soft Closer Mechanism | Gri / Grey | 1 Takım / 1 Kit | 50 | 1.250 |

Softline 6901

50 KG YAVAŞLATICI SİSTEM • 50 KG SOFT CLOSER SYSTEM

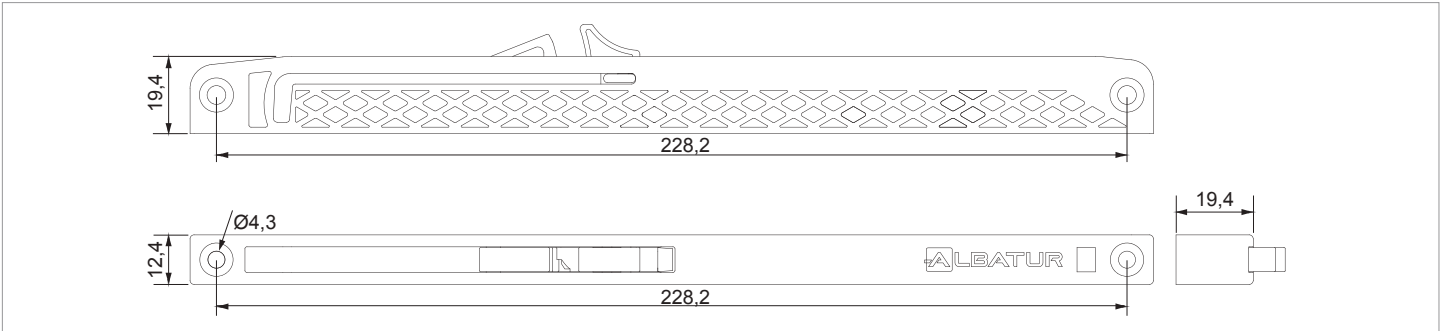

| Kod / Code No | Açıklama / Description | Renk / Colour | Birim / Unit | | |
|---------------|---|---------------|-----------------|----|-------|
| 117-6901-1610 | 50 Kg Yavaşlatıcı Mekanizma / 50 Kg Soft Closer Mechanism | Gri / Grey | 1 Takım / 1 Kit | 50 | 1.250 |

Softline 6820

80 KG YAVAŞLATICI SİSTEM • 80 KG SOFT CLOSER SYSTEM

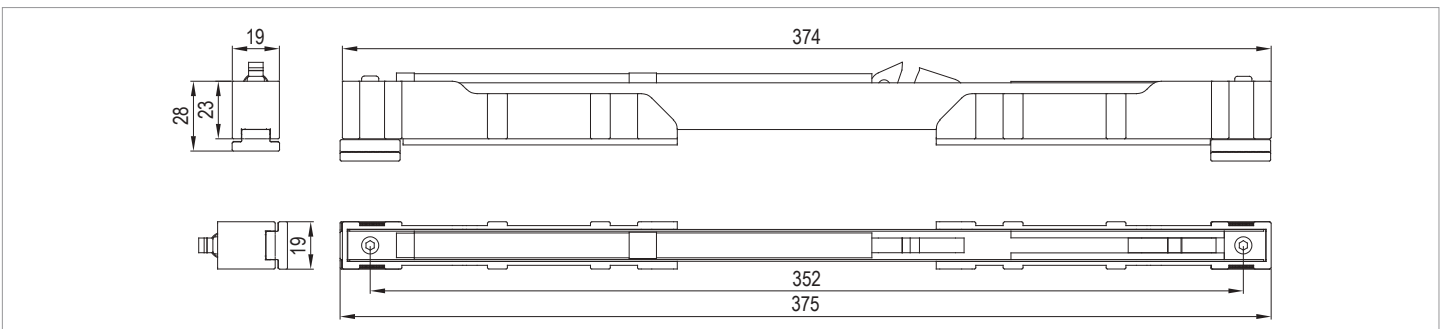

| Kod / Code No | Açıklama / Description | Renk / Colour | Birim / Unit | | |
|---------------|---|---------------|-----------------|----|-----|
| 117-6820-1600 | 80 Kg Yavaşlatıcı Mekanizma / 80 Kg Soft Closer Mechanism | Gri / Grey | 1 Takım / 1 Kit | 24 | 576 |

Softline 6990

80 KG YAVAŞLATICI SİSTEM • 80 KG SOFT CLOSER SYSTEM

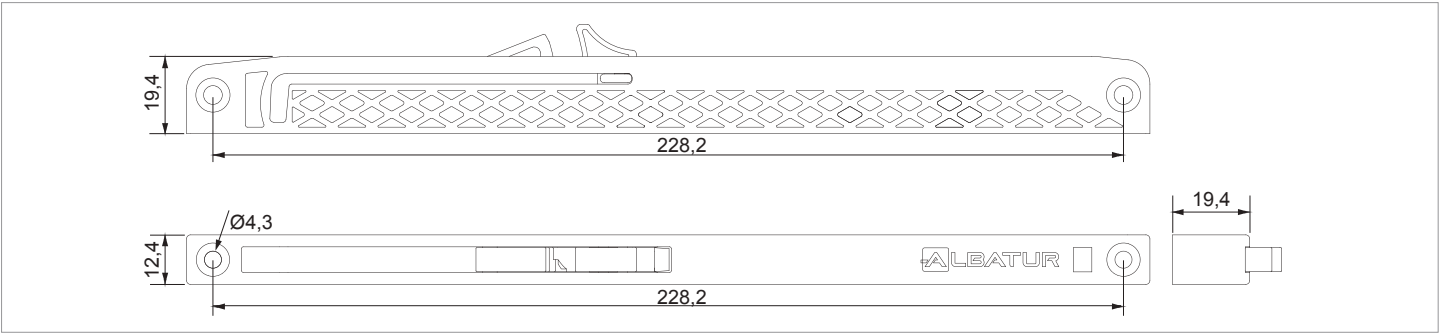

| Kod / Code No | Açıklama / Description | Renk / Colour | Birim / Unit | | |
|---------------|---|---------------|-----------------|----|-------|
| 117-6990-1610 | 80 Kg Yavaşlatıcı Mekanizma / 80 Kg Soft Closer Mechanism | Gri / Grey | 1 Takım / 1 Kit | 50 | 1.250 |

Softline 6700

80 KG YAVAŞLATICI SİSTEM • 80 KG SOFT CLOSER SYSTEM

Özel Üretim
Special Production

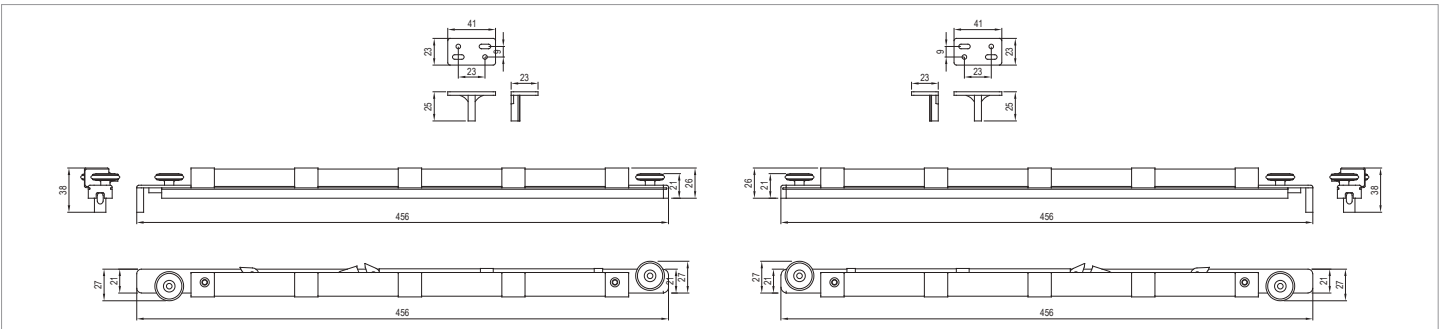
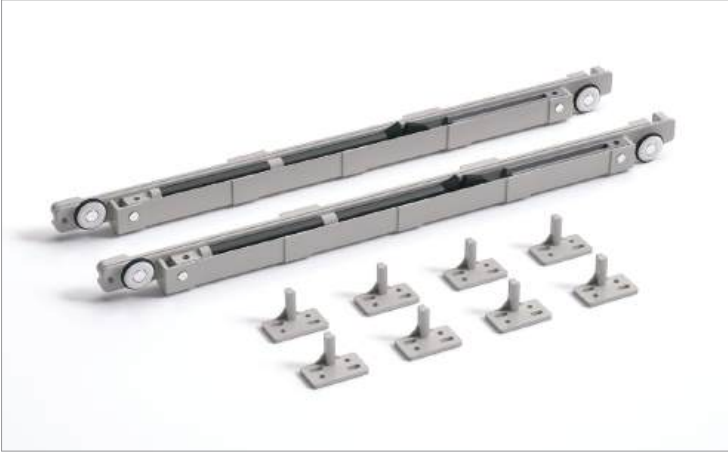

| Kod / Code No | Açıklama / Description | Renk / Colour | Birim / Unit | | |
|---------------|---|---------------|-----------------|----|-----|
| 117-6700-1600 | 80 Kg Yavaşlatıcı Mekanizma / 80 Kg Soft Closer Mechanism | Gri / Grey | 1 Takım / 1 Kit | 24 | 576 |

Softline 6922

50 KG YAVAŞLATICI SİSTEM • 50 KG SOFT CLOSER SYSTEM

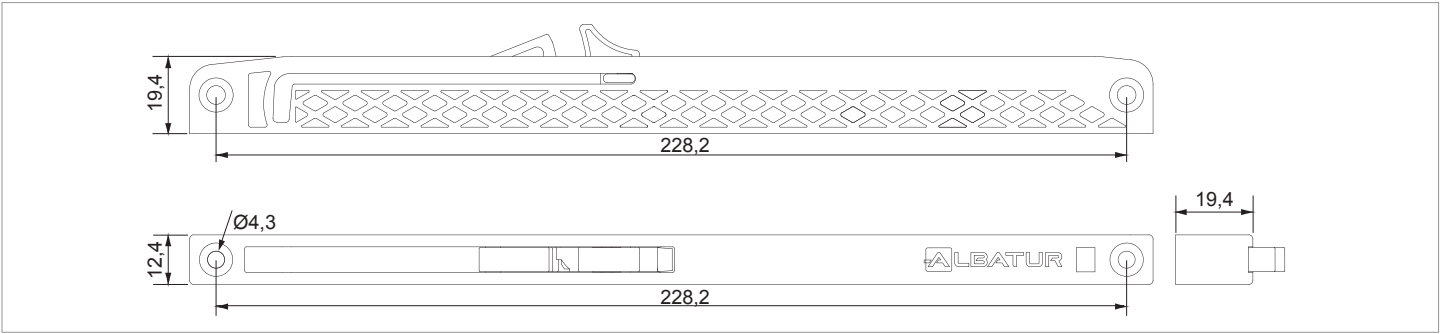

| Kod / Code No | Açıklama / Description | Renk / Colour | Birim / Unit | | |
|---------------|---|---------------|-----------------|----|-------|
| 117-6922-1610 | 50 Kg Yavaşlatıcı Mekanizma / 50 Kg Soft Closer Mechanism | Gri / Grey | 1 Takım / 1 Kit | 50 | 1.250 |

Softline 6921

70 KG YAVAŞLATICI SİSTEM • 70 KG SOFT CLOSER SYSTEM

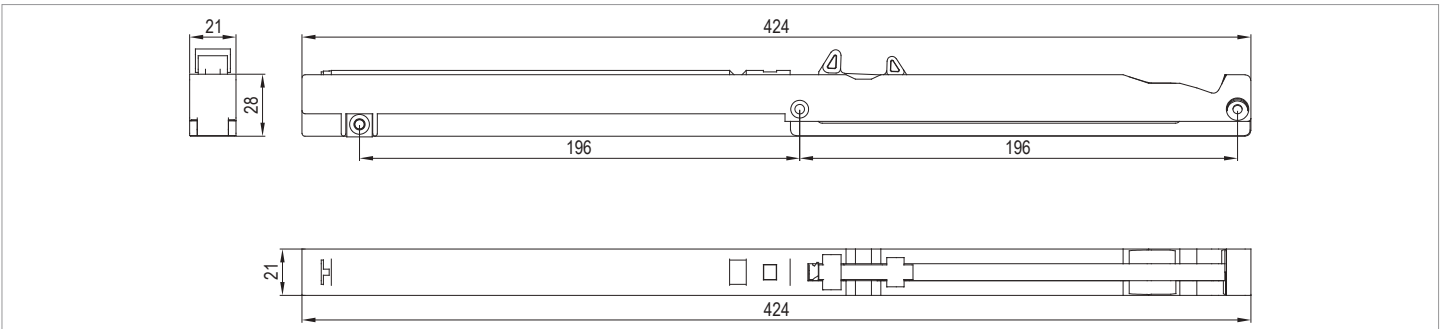



| Kod / Code No | Açıklama / Description | Renk / Colour | Birim / Unit | | |
|---------------|---|---------------|-----------------|----|-------|
| 117-6921-1600 | 70 Kg Yavaşlatıcı Mekanizma / 60 Kg Soft Closer Mechanism | Gri / Grey | 1 Takım / 1 Kit | 24 | 1.200 |

Softline 6959

50 KG YAVAŞLATICI SİSTEM • 50 KG SOFT CLOSER SYSTEM

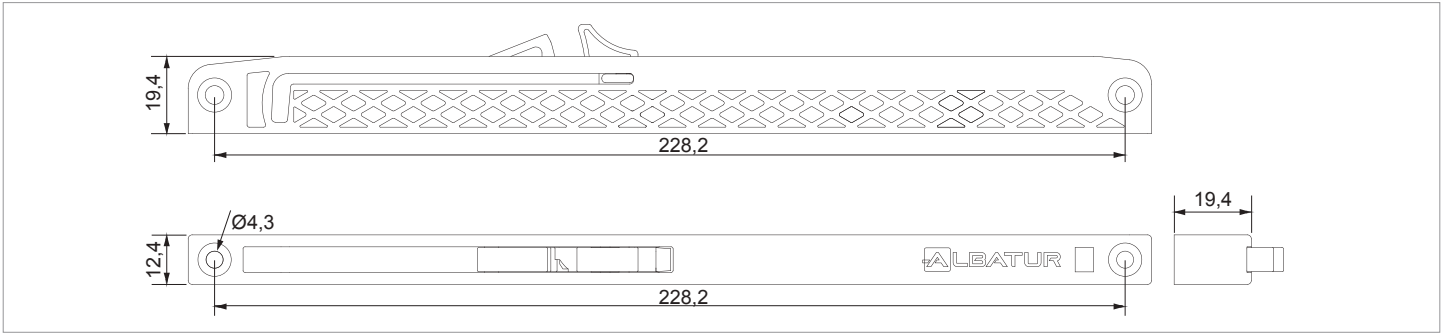
Yeni Ürün
New Product



| Kod / Code No | Açıklama / Description | Renk / Colour | Birim / Unit |  |  |
|---------------|---|---------------|-----------------|--|--|
| 117-6959-1610 | 50 Kg Yavaşlatıcı Mekanizma / 50 Kg Soft Closer Mechanism | Gri / Grey | 1 Takım / 1 Kit | 50 | 1.250 |



Softline **Series**

Pulltens®

Çek-Ger Serisi

Pull & Tension Series

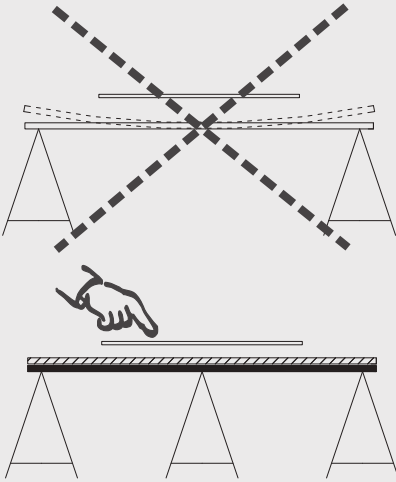

Cam, ayna v.s. grubu ahşap panele yapıştırılırken, panel kesinlikle çok hassas ve düz bir zeminde tutulmalıdır. Aksi takdirde yapıştırılma anındaki tüm atıklık, daha sonra çekger gergi yada kulp marifeti ile düzeltilemez bir durum oluşturur.

While the installation glass, mirror etc.. on the panel, the panel must be kept on a very sensitive and flat surface. If not, all the bending while the stick on the panel; later on, it cannot be corrected with the tension or handle

Neden ÇEK-GER kullanılmalı?

Hava şartları, rutubet, taşıma ve istifleme (depolama) nedeniyle mdf, sunta ve ahşap kapak malzemelerde kalıcı burkulma ve atıklık oluşabilmektedir. Ayrıca ahşap üzerine eklenen cam, ayna ve diğer aksesuarlar kapağın düzlemselliğine etken faktörlerdir. Kapaklarımızda bu atıklığı gergi sistemleri ve yan duvarlarda kullanacağımız alüminyum dikme kulplar (dik düzlemde ahşabın düzlemselliğini sağlayabilecek kesit ve atık oluşabilecek ekseninde ahşabın mukavemetinden daha etkin dirençli alüminyum yada metal ekstrüde profil ve aksesuarlar) ile çözmek mümkündür. Lakin dikme kulplar ile çözüm üretim esnasında etkin olmasına karşın, depolama şartlarına bağlı olarak 1 yada 2 ay sonra açılan ambalajlı ürünlerde yetersiz kaldığı görülmektedir. Bu tip ürün gruplarında çekger mekanizmaları kapaktaki atıklıkları, kullandıkları eksen yönünde çözüme kavuşturmaktadır. En ölçüsü 40 cm e kadar olan kapaklarda merkezden bir adet, daha büyük en ölçülerinde iki adet çekger kullanımı önerilmektedir. Cam ve ayna yapıştırılan kapaklarda çekger kullanımında dikkat edilmesi gereken bazı hususlar: Cam, ayna v.s. grubu ahşap panele yapıştırılırken ahşap panel kesinlikle çok hassas ve düz bir zeminde tutulmalıdır. Aksi takdirde yapıştırılma anındaki tüm atıklık daha sonra çekger gergi yada kulp marifeti ile düzeltilemez bir durum oluşturmaktadır.

Why Pull-Tension ?

On the wooden door in materials, MDF materials and chipboard materials can be permanent strain and swelling. Because of bad weather condition, humidity, transport and storage factors. Also other factors effecting the flatness of the wooden covers; installing glass, mirror and other accessories on the wooden panel. Its possible to solve this swelling problem for using Pull & Tension Equipments and using the pillar aluminium handles on the side walls of the wooden panel. However its effective solution using the pillar aluminium handles during the production but it seems to be inadequate solution if the products keep in storage 1 or 2 months. In this type of products group, Pull & Tension mechanism resolve this swelling problem on the cover using the their axis direction side. Width measure to 40 cm covers, from the center of the cover 1 pcs Pul I& Tension should be using, more larger width measure 2 pcs Pull & Tension recommended. Issues to be considered Pull & Tension when used glass and mirros on the cover: When use glass and mirros on the wooden cover panel; panel definitely should be keep on the very sensitive and flat ground. Otherwise during the installing glass or mirros, at this moment swelling that may occur unimprovable situation.



Bu serideki tüm ürünleri incelemek için QR kodu okutabilirsiniz.

You can search the QR code to see all the products in these series.

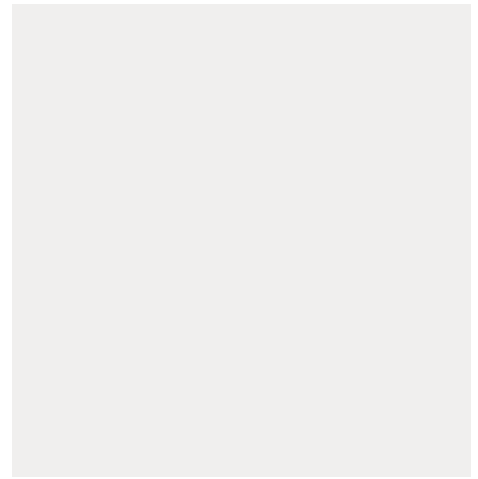
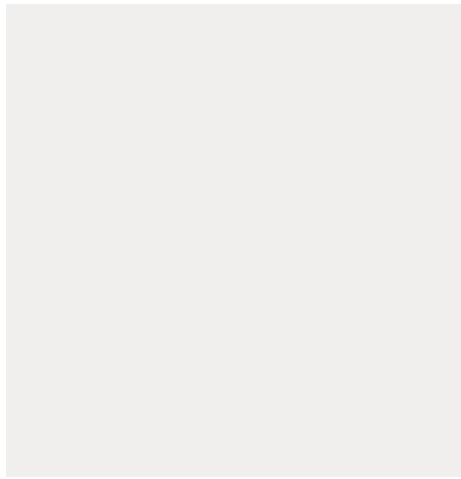
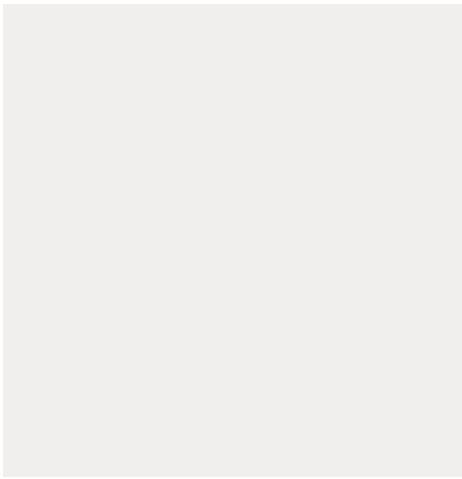
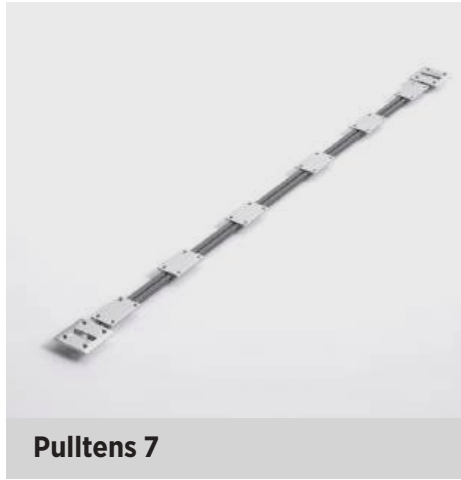

Pulltens 1

METAL ÇEK-GER • PULL & TENSION METAL

CG-01

■ 118-0001

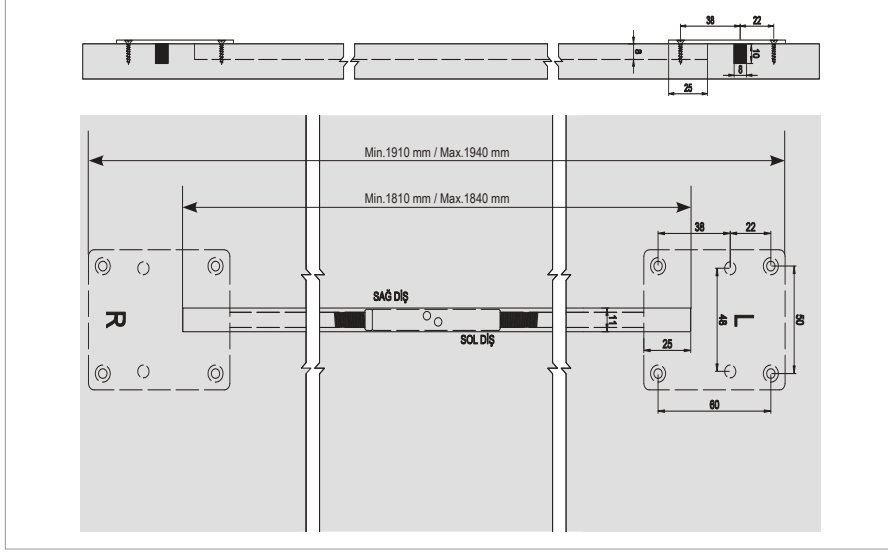

Ölçülerde değişiklik yapma hakkı saklıdır. Reserves the right to the change of the dimensions.



■ Bilgi / Information

- Birim adet fiyatlarıdır.
- 40 cm'den geniş kapaklarda 2 adet kullanımı önerilir.
- Özel ölçü için müşteri temsilciniz ile görüşünüz.
- Maksimum kapak yüksekliği 2.200 mm tavsiye edilir.
- Minimum kapak yüksekliği 1.700 mm tavsiye edilir.

- Unit Prices
- More than 40 cm width doors, recommended to use 2 pcs
- For special size please contact customer representative.
- Maximum door height is 2.200 mm recommended.
- Minimum door height is 1.700 mm recommended.

| Kod / Code No | Açıklama / Description | Renk / Colour | Birim / Unit |  |  |
|---------------|---|-----------------------|----------------|--|--|
| 118-0001-1600 | CG 01 - Metal Başlı Çek-Ger Mekanizması - Pull & Tension Equipments - Metal | Galvaniz / Galvanized | 1 Adet / 1 Pcs | 24 | 384 |

Pulltens 2

METAL BOY ÇEK-GER • PULL & TENSION METAL

CG-02

■ 118-0002

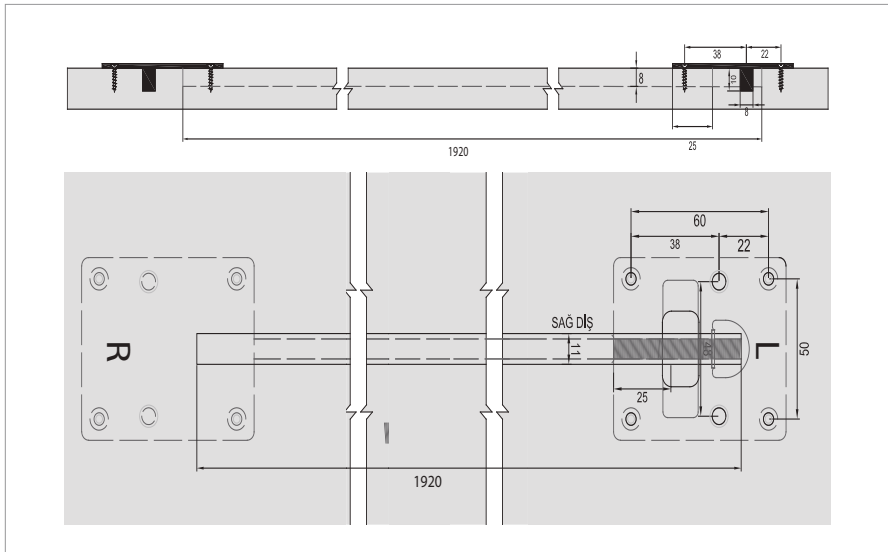



Ölçülerde değişiklik yapma hakkı saklıdır. Reserves the right to the change of the dimensions.



■ Bilgi / Information

- Birim adet fiyatlarıdır.
- 40 cm'den geniş kapaklarda 2 adet kullanımı önerilir.
- Özel ölçü için müşteri temsilciniz ile görüşünüz.
- Maksimum kapak yüksekliği 2.200 mm tavsiye edilir.
- Minimum kapak yüksekliği 1.800 mm tavsiye edilir.

- Unit Prices
- More than 40 cm width doors, recommended to use 2 pcs
- For special size please contact customer representative.
- Maximum door height is 2.200 mm recommended.
- Minimum door height is 1.800 mm recommended.

| Kod / Code No | Açıklama / Description | Renk / Colour | Birim / Unit |  |  |
|---------------|---|-----------------------|----------------|---|---|
| 118-0002-1600 | CG 02 - Metal Başlı Boy Çek-Ger Mekanizması - Pull & Tension Equipments - Metal | Galvaniz / Galvanized | 1 Adet / 1 Pcs | 30 | 360 |

Pulltens 5

PLASTİK BAŞLI ÇEK-GER • PULL & TENSION PLASTIC

CG-05

■ 118-0005

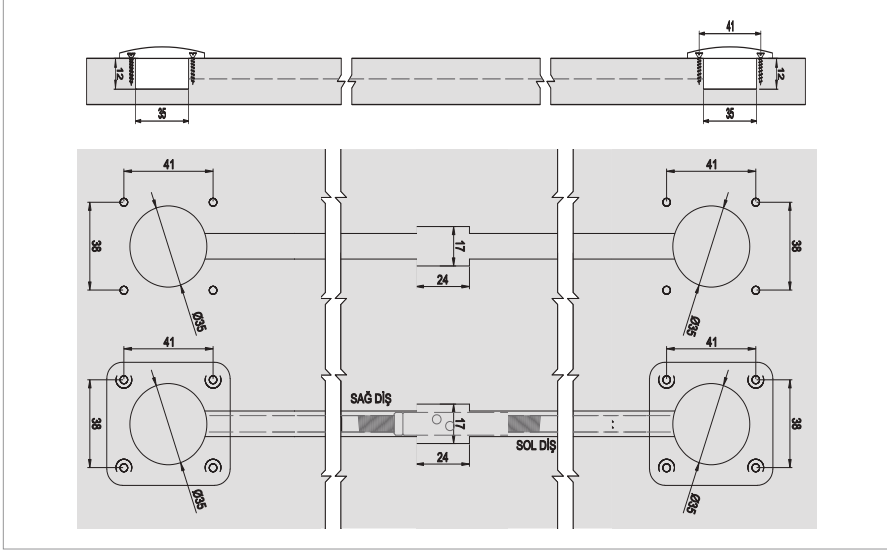

Ölçülerde değişiklik yapma hakkı saklıdır. Reserves the right to the change of the dimensions.

■ Bilgi / Information

- Birim adet fiyatlandırılır.
- 40 cm'den geniş kapaklarda 2 adet kullanımı önerilir.
- Özel ölçü için müşteri temsilciniz ile görüşünüz.
- Maksimum kapak yüksekliği 2.200 mm tavsiye edilir.
- Minimum kapak yüksekliği 1.700 mm tavsiye edilir.

• Unit Prices

- More than 40 cm width doors, recommended to use 2 pcs
- For special size please contact customer representative.
- Maximum door height is 2.200 mm recommended.
- Minimum door height is 1.700 mm recommended.

| Kod / Code No | Açıklama / Description | Renk / Colour | Birim / Unit |  |  |
|---------------|---|-----------------------|----------------|--|--|
| 118-0005-1600 | CG 05 - Plastik Başlı Çek-Ger Mekanizması - Pull & Tension Equipments - Plastic | Galvaniz / Galvanized | 1 Adet / 1 Pcs | 24 | 384 |

Pulltens 6

ALÜMİNYUM ÇEK-GER • PULL & TENSION ALUMINIUM

CG-06

■ 118-0006

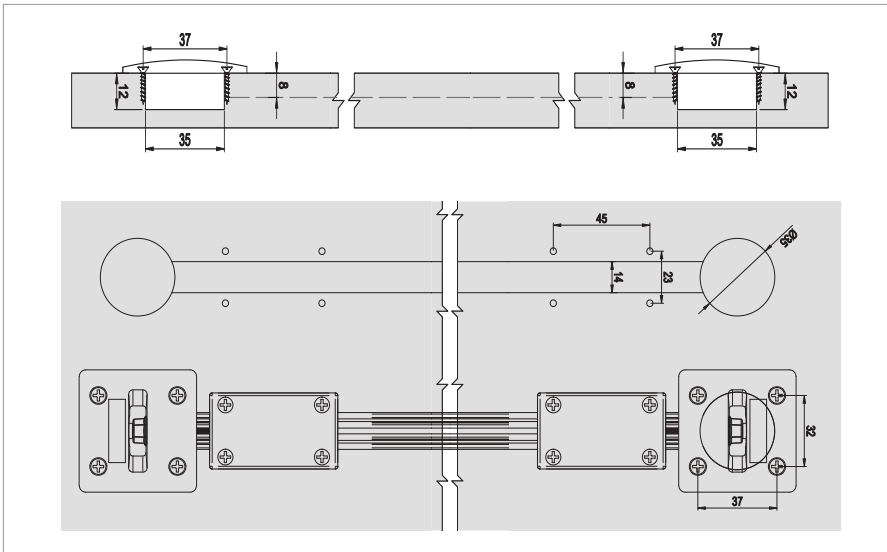
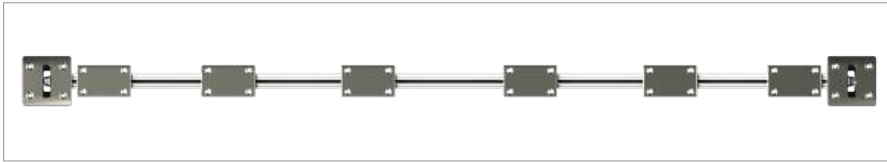



Ölçülerde değişiklik yapma hakkı saklıdır. Reserves the right to the change of the dimensions.

■ Bilgi / Information

- Birim adet fiyatlandırılır.
- 40 cm'den geniş kapaklarda 2 adet kullanımı önerilir.
- 3.000 mm kadar özel üretim yapılabilir.
- Maksimum kapak yüksekliği 2.300 mm tavsiye edilir.
- Minimum kapak yüksekliği 800 mm tavsiye edilir.

• Unit Prices

- More than 40 cm width doors, recommended to use 2 pcs
- Special production can be made up to 3.000 mm.
- For special size please contact customer representative.
- Maximum door height is 2.300 mm recommended.
- Minimum door height is 800 mm recommended.

| Kod / Code No | Açıklama / Description | Renk / Colour | Birim / Unit |  |  |
|---------------|---|-----------------|----------------|---|---|
| 118-0006-1400 | Alüminyum Çek-Ger Mekanizması - Pull & Tension Equipments - Aluminium | Pres / Uncoated | 1 Adet / 1 Pcs | 30 | 360 |

Pulltens 7

ALÜMİNYUM ZAMAK BAŞLI ÇEK-GER • PULL & TENSION ALUMINIUM

CG-07

■ 118-0007

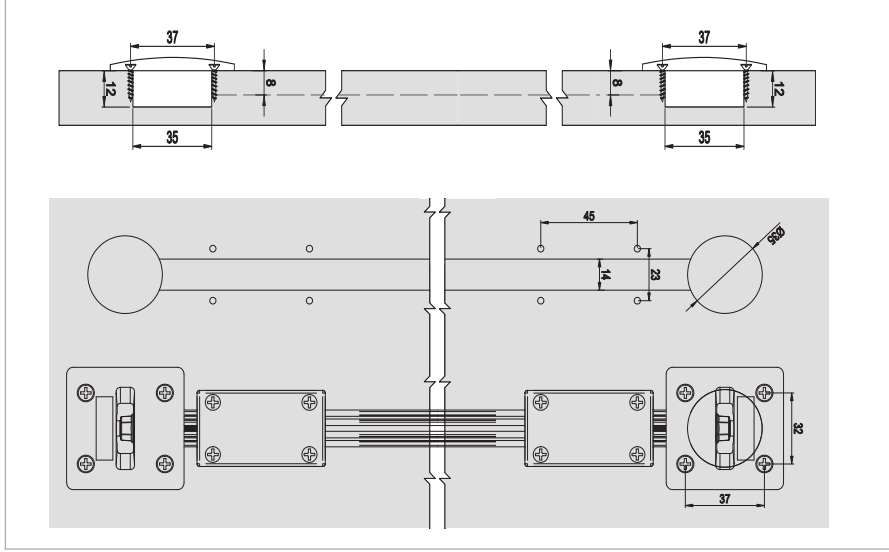
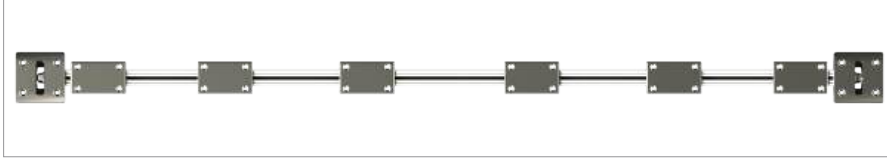

Bilgi / Information

- Birim adet fiyatlarıdır.
- 40 cm'den geniş kapaklarda 2 adet kullanımı önerilir.
- 3.000 mm kadar özel üretim yapılabilir.
- Maksimum kapak yüksekliği 2.300 mm tavsiye edilir.
- Minimum kapak yüksekliği 800 mm tavsiye edilir.

- Unit Prices
- More than 40 cm width doors, recommended to use 2 pcs
- Special production can be made up to 3.000 mm.
- For special size please contact customer representative.
- Maximum door height is 2.300 mm recommended.
- Minimum door height is 800 mm recommended.

| Kod / Code No | Açıklama / Description | Renk / Colour | Birim / Unit | | |
|---------------|---|-----------------|----------------|----|-----|
| 118-0007-1400 | Zamak Başlı Alüminyum Çek-Ger Mekanizması - Pull & Tension Equipment Alm. | Pres / Uncoated | 1 Adet / 1 Pcs | 30 | 360 |

Pulltens 9

ALÜMİNYUM BOY ÇEK-GER • PULL & TENSION ALUMINIUM

CG-09

■ 118-0009

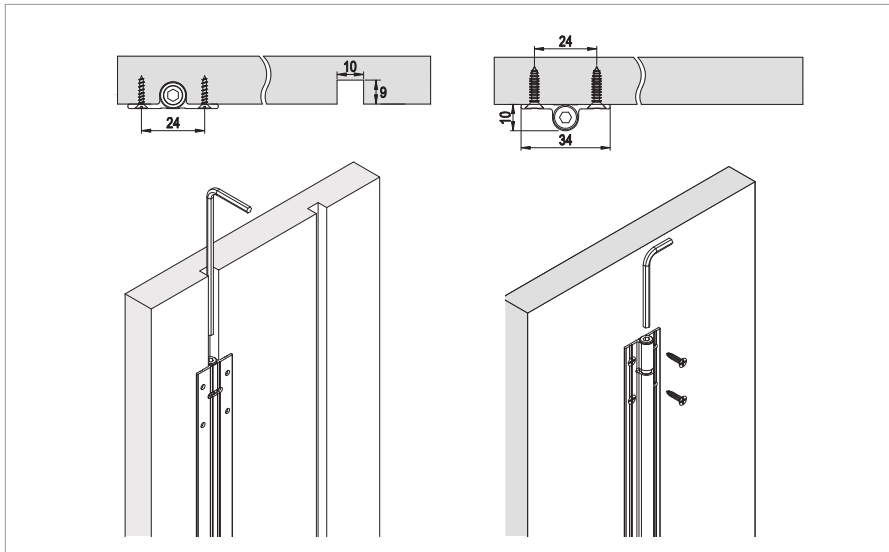
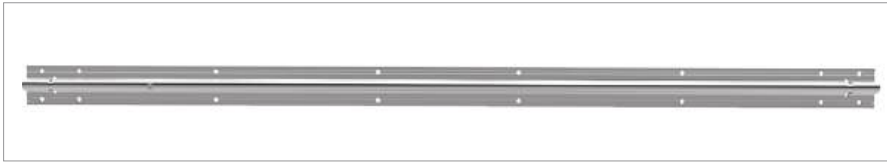

Bilgi / Information

- Birim adet fiyatlarıdır.
- 40 cm'den geniş kapaklarda 2 adet kullanımı önerilir.
- Minimum 1.600 - Maksimum 2.500 mm kadar özel üretim yapılabilir.
- Maksimum kapak yüksekliği 2.200 mm tavsiye edilir.
- Minimum kapak yüksekliği 2.000 mm tavsiye edilir.

- Unit Prices
- More than 40 cm width doors, recommended to use 2 pcs
- From Minimum 1.600 mm up to Maximum 2.500 mm can be made special production
- For special size please contact customer representative.
- Maximum door height is 2.200 mm recommended.
- Minimum door height is 2.000 mm recommended.

| Kod / Code No | Açıklama / Description | Renk / Colour | Birim / Unit | | |
|---------------|---|------------------------|----------------|----|-----|
| 118-0009-1400 | Alüminyum Boy Gergi Mekanizması - Aluminium Tension Mechanism | Eloksal / Mat Anodized | 1 Adet / 1 Pcs | 30 | 360 |

Pulltens 11

ZAMAK BAŞLI GİZLİ ÇEK-GER DONANIMI • PULL & TENSION METAL

■ 118-0011

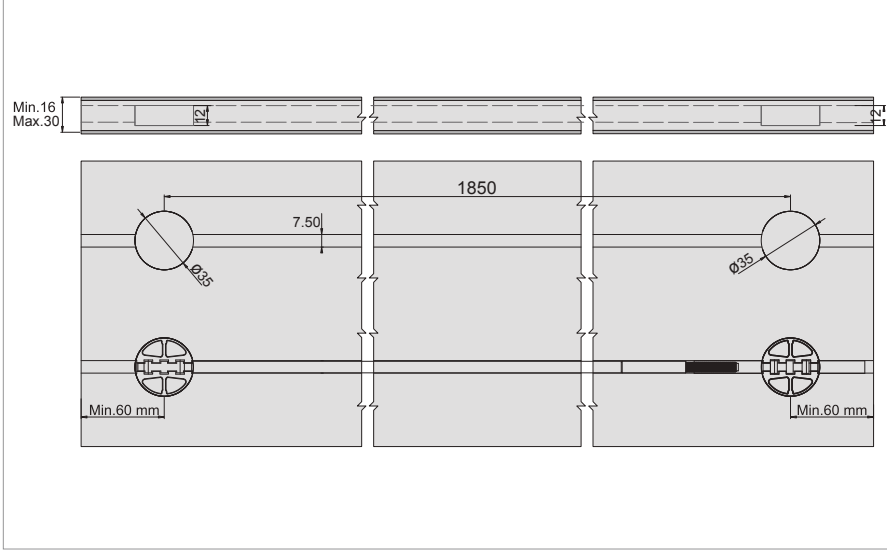



Ölçülerde değişiklik yapma hakkı saklıdır. Reserves the right to the change of the dimensions.



Bilgi / Information

- Birim adet fiyatlandırır.
- 40 cm'den geniş kapaklarda 2 adet kullanımı önerilir.
- Özel ölçü için müşteri temsilciniz ile görüşünüz.
- Maksimum kapak yüksekliği 2.200 mm tavsiye edilir.
- Minimum kapak yüksekliği 1.950 mm tavsiye edilir.

- Unit Prices
- More than 40 cm width doors, recommended to use 2 pcs
- For special size please contact customer representative.
- Maximum door height is 2.200 mm recommended.
- Minimum door height is 1.950 mm recommended.

| Kod / Code No | Açıklama / Description | Renk / Colour | Birim / Unit |  |  |
|---------------|---|----------------------|----------------|--|--|
| 118-0011-1600 | Zamak Başlı Alüminyum Çek-Ger Mekanizması - Pull & Tension Equipment Alm. | Galvaniz /Galvanized | 1 Adet / 1 Pcs | 30 | 360 |

Pulltens 12

METAL ÇEK-GER DONANIMI • PULL & TENSION METAL

■ 118-0012

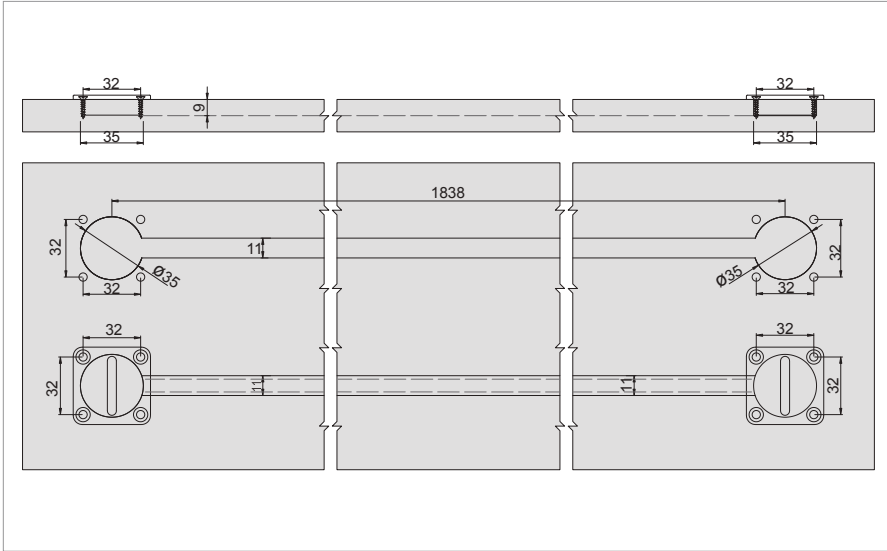



Ölçülerde değişiklik yapma hakkı saklıdır. Reserves the right to the change of the dimensions.



Bilgi / Information

- Birim adet fiyatlandırır.
- 40 cm'den geniş kapaklarda 2 adet kullanımı önerilir.
- Özel ölçü için müşteri temsilciniz ile görüşünüz.
- Maksimum kapak yüksekliği 2.200 mm tavsiye edilir.
- Minimum kapak yüksekliği 1.950 mm tavsiye edilir.

- Unit Prices
- More than 40 cm width doors, recommended to use 2 pcs
- For special size please contact customer representative.
- Maximum door height is 2.200 mm recommended.
- Minimum door height is 1.950 mm recommended.

| Kod / Code No | Açıklama / Description | Renk / Colour | Birim / Unit |  |  |
|---------------|---|----------------------|----------------|---|---|
| 118-0012-1600 | Zamak Başlı Alüminyum Çek-Ger Mekanizması - Pull & Tension Equipment Alm. | Galvaniz /Galvanized | 1 Adet / 1 Pcs | 30 | 360 |

Group 119

BarnDoor®

Üstten Askı Ahşap Sürme Kapı Serisi

Top Hanger Wooden Sliding Door Series



Bu serideki tüm ürünleri incelemek için QR kodu okutabilirsiniz.

You can search the QR code to see all the products in these series.

BarnDoor

ÜSTTEN ASKI AHŞAP SÜRME KAPI SERİSİ • TOP HANGER WOODEN SLIDING DOOR SERIES



BarnDoor **8800**



BarnDoor **8820**



BarnDoor **8900**

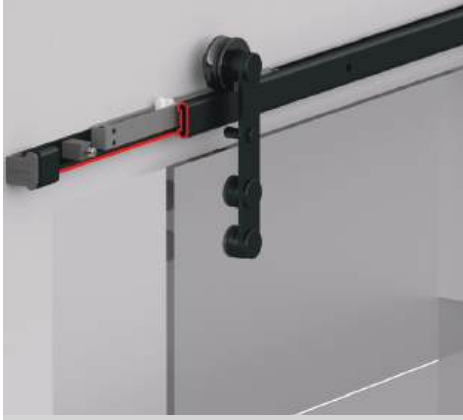

BarnDoor **8920**



BarnDoor **8810**



BarnDoor **8830**

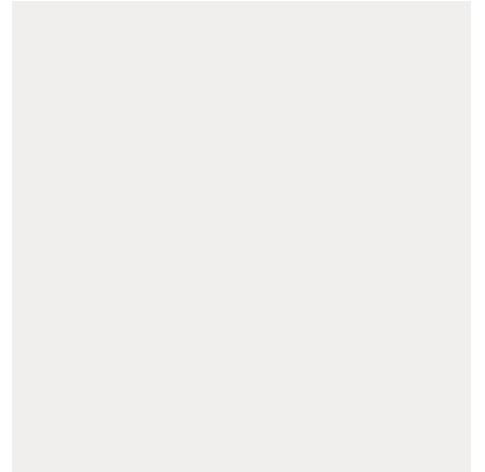
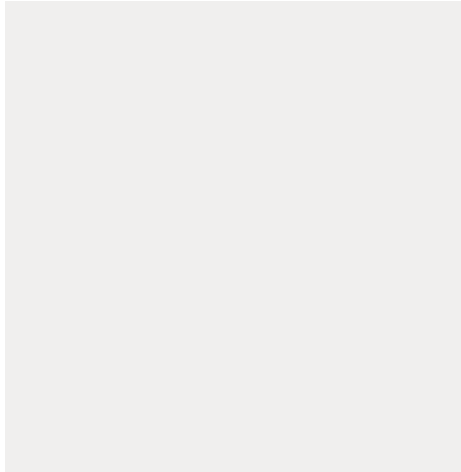
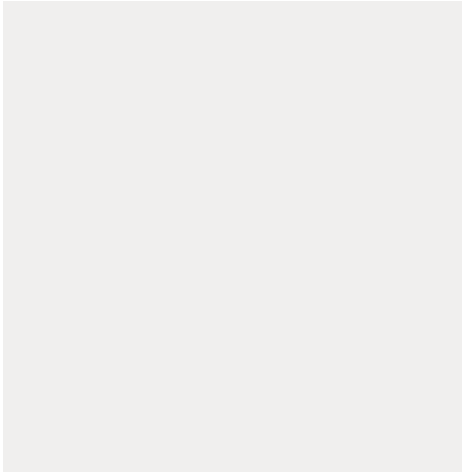
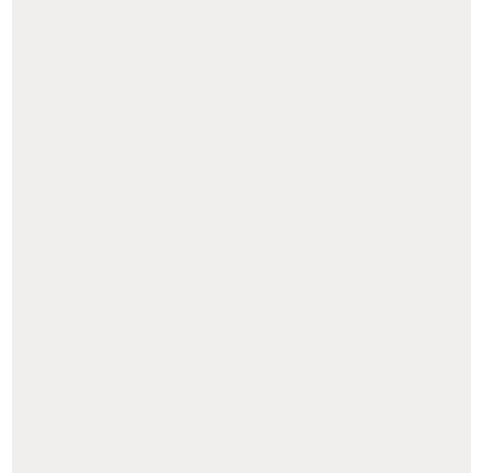
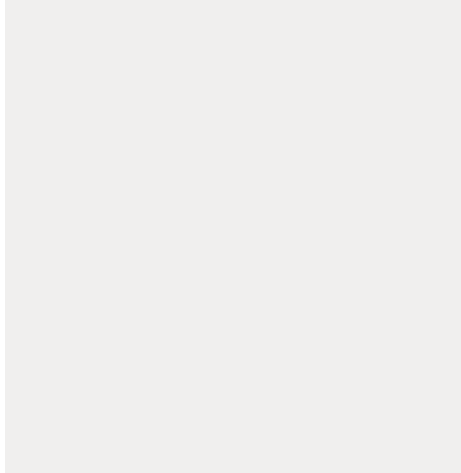
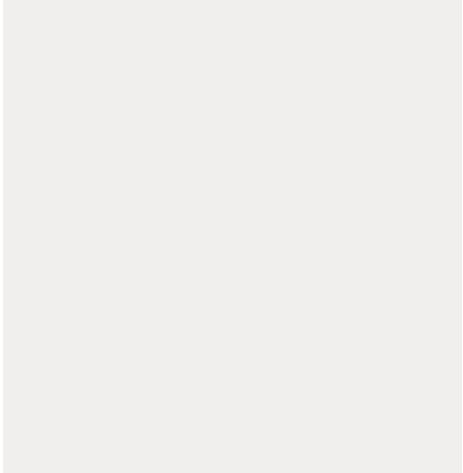

BarnDoor 8800

ÜSTTEN ASKI AHŞAP SÜRME KAPI SİSTEMİ • TOP HANGER WOODEN SLIDING DOOR SYSTEM



Bilgi / Information

- 2.300 - 2.600 - 2.900 - 3.200 - 3.500 mm özel boylar yapılmakta olup, her bir ürün 200 mm'ye kadar kısaltma yapılabilir.
- Special sizes Can be made 2.300 - 2.600 - 2.900 - 3.200 - 3.500 mm each product can be shortened up to 200 mm.



119-8800 1 Takım İçeriği / 1 Kit Includes



Teknik Detay / Technical Detail

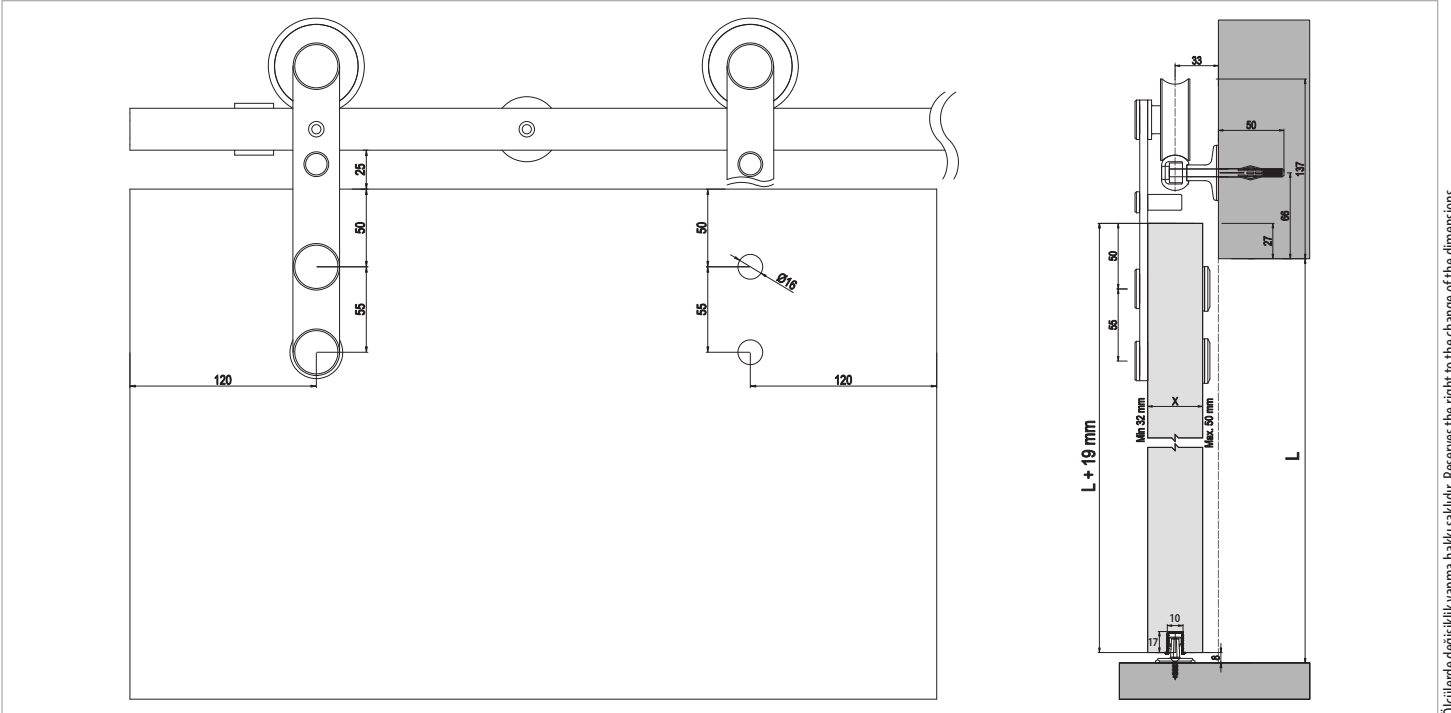

Ölçülerde değişiklik yapma hakkı saklıdır. Reserves the right to the change of the dimensions.

Uygulama / Application



SETBOX Paketleme / SETBOX Packaging

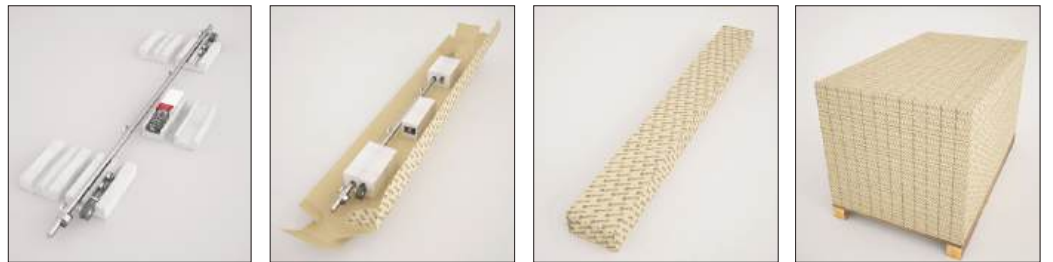

| Kod / Code No | Açıklama / Description | Renk / Colour | L (mm) | Birim / Unit | | |
|--------------------|--|---------------|----------|----------------|---|----|
| 119-8800-3430-1700 | Üstten Askı Sürme Kapi Sistemi / Top Hanger Sliding System | Siyah / Black | 1.700 mm | 1 Kapi / 1 Kit | 1 | 30 |
| 119-8800-3430-2000 | Üstten Askı Sürme Kapi Sistemi / Top Hanger Sliding System | Siyah / Black | 2.000 mm | 1 Kapi / 1 Kit | 1 | 30 |

BarnDoor 8820

80 KG ÇİFT YÖNE YAVAŞLATICILI SÜRME KAPI SİSTEMİ • SLIDING DOOR SYSTEM - TWO WAY SOFT CLOSING



Bilgi / Information

- 2.500 - 3.000 - 3.500 - 4.000 mm özel boylar yapılmakta olup, özel boy ürünler 500 mm'ye kadar kısaltma yapılabilir.
- Special sizes Can be made 2.500 - 3.000 - 3.500 - 4.000 mm can be shortened up to 500 mm for special sizes.

Yavaşlatıcı Alternatifi / Soft Closer Alternative

- Sistem üzerinde entegre yavaşlatıcı mevcuttur.
- The system has integrated soft closer.



119-8820 1 Takım İçeriği / 1 Kit Includes



Teknik Detay / Technical Detail

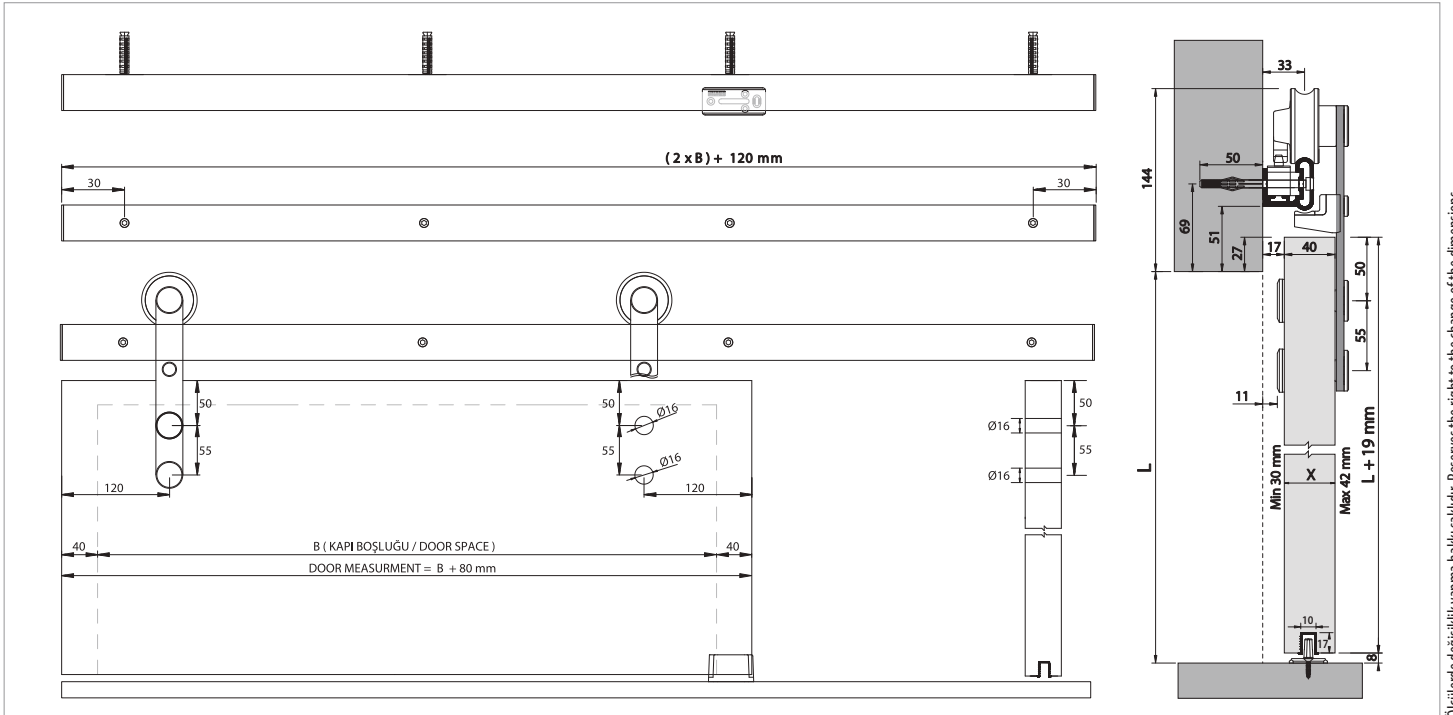

Uygulama / Application



SETBOX Paketleme / SETBOX Packaging

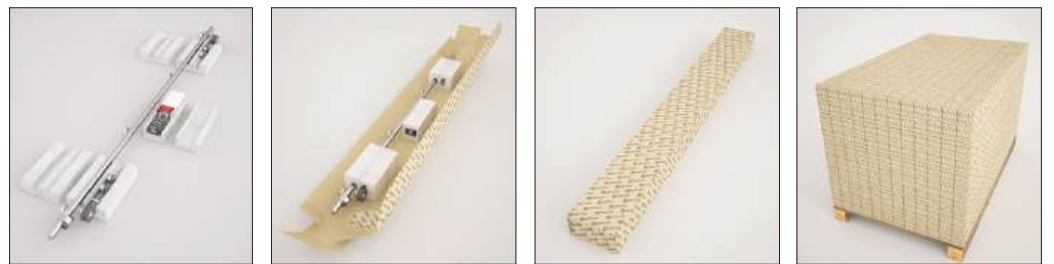

| Kod / Code No | Açıklama / Description | Renk / Colour | L (mm) | Birim / Unit | | |
|--------------------|---|---------------|----------|----------------|---|----|
| 119-8820-3430-1700 | 80 Kg Yavaşlatıcılı Sürgü Kapi Sistemi / Sliding Door Has Soft Closing System | Siyah / Black | 1.700 mm | 1 Kapi / 1 Kit | 1 | 30 |
| 119-8820-3430-2000 | 80 Kg Yavaşlatıcılı Sürgü Kapi Sistemi / Sliding Door Has Soft Closing System | Siyah / Black | 2.000 mm | 1 Kapi / 1 Kit | 1 | 30 |

BarnDoor 8900

ÜSTTEN ASKI CAM SÜRME KAPI SİSTEMİ • TOP HANGER GLASS SLIDING DOOR SYSTEM



Bilgi / Information

- 2.300 - 2.600 - 2.900 - 3.200 - 3.500 mm özel boylar yapılmakta olup, her bir ürün 200 mm'ye kadar kısaltma yapılabilir.
- Special sizes Can be made 2.300 - 2.600 - 2.900 - 3.200 - 3.500 mm each product can be shortened up to 200 mm.



119-8900 1 Takım İçeriği / 1 Kit Includes



Teknik Detay / Technical Detail

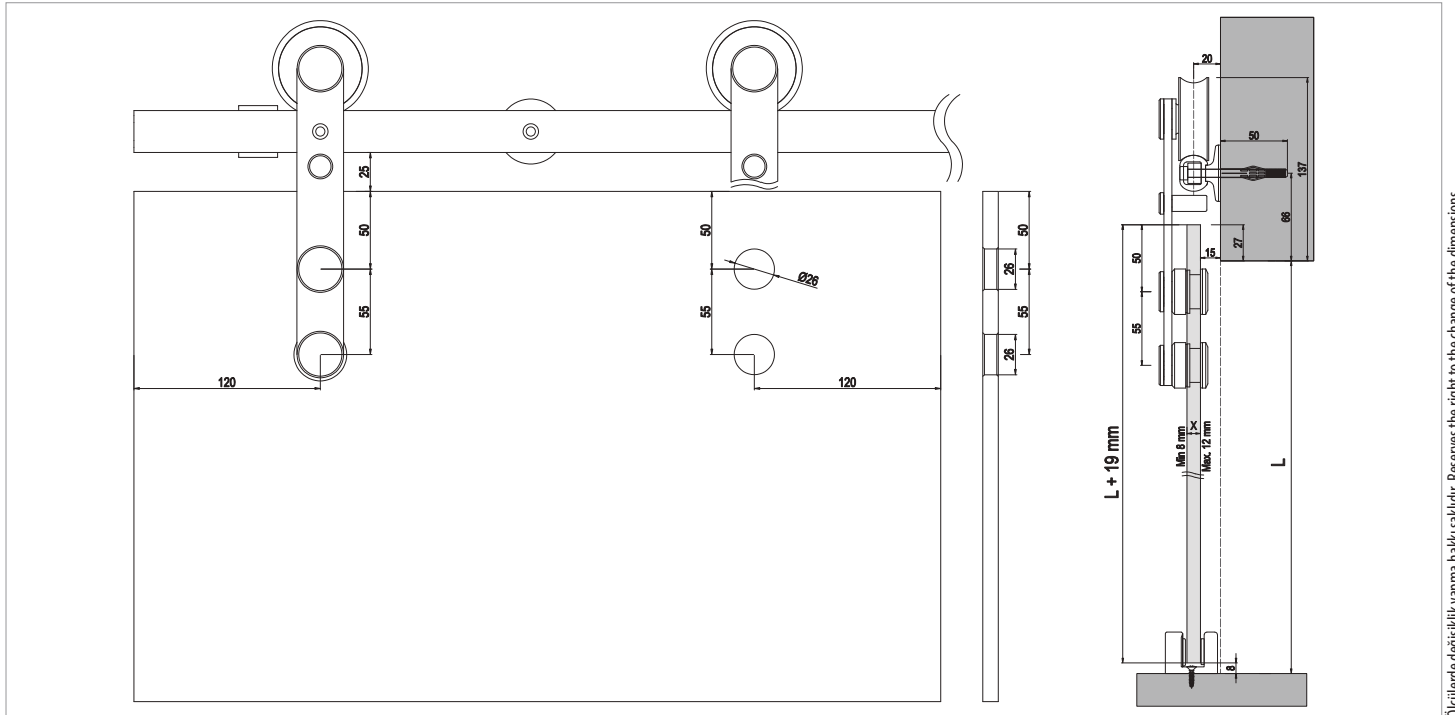

Ölçülerde değişiklik yapma hakkı saklıdır. Reserves the right to the change of the dimensions.

Uygulama / Application



SETBOX Paketleme / SETBOX Packaging

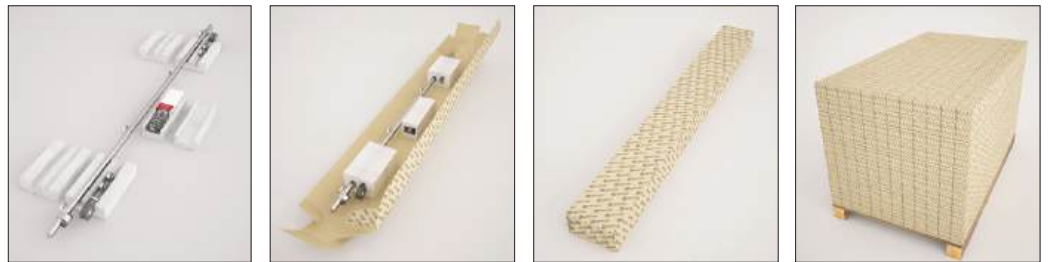

| Kod / Code No | Açıklama / Description | Renk / Colour | L (mm) | Birim / Unit | | |
|--------------------|---|---------------|----------|----------------|---|----|
| 119-8900-3410-1700 | Üstten Askı Cam Sürme Kapi Sistemi / Top Hanger Glass Sliding Door System | Gri / Grey | 1.700 mm | 1 Kapi / 1 Kit | 1 | 30 |
| 119-8900-3410-2000 | Üstten Askı Cam Sürme Kapi Sistemi / Top Hanger Glass Sliding Door System | Gri / Grey | 2.000 mm | 1 Kapi / 1 Kit | 1 | 30 |

BarnDoor 8920

80 KG ÇİFT YÖNE YAVAŞLATICILI SÜRME CAM KAPI SİSTEMİ • SLIDING GLASS DOOR SYSTEM - TWO WAY SOFT CLOSING



Bilgi / Information

- 2.500 - 3.000 - 3.500 - 4.000 mm özel boylar yapılmakta olup, özel boy ürünler 500 mm'ye kadar kısaltma yapılabilir.
- Special sizes Can be made 2.500 - 3.000 - 3.500 - 4.000 mm can be shortened up to 500 mm for special sizes.

Yavaşlatıcı Alternatifi / Soft Closer Alternative

- Sistem üzerinde entegre yavaşlatıcı mevcuttur.
- The system has integrated soft closer.



119-8920 1 Takım İçeriği / 1 Kit Includes

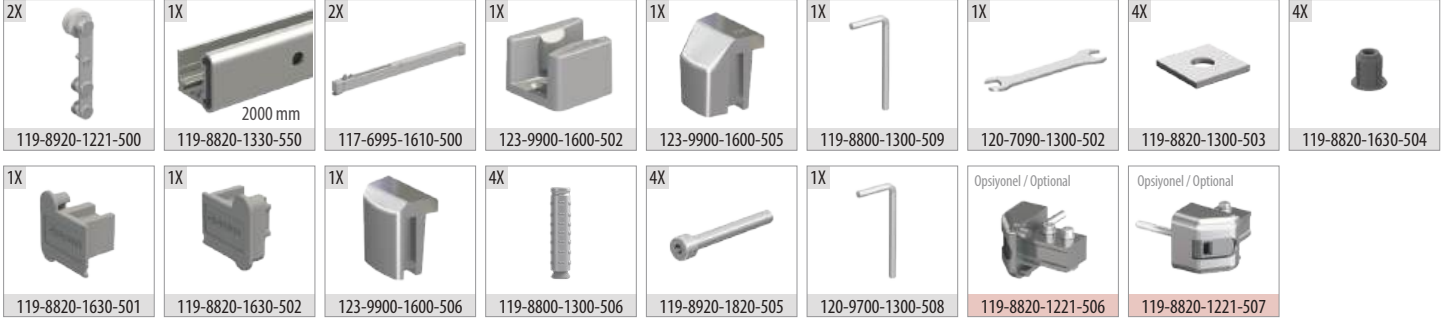

Teknik Detay / Technical Detail

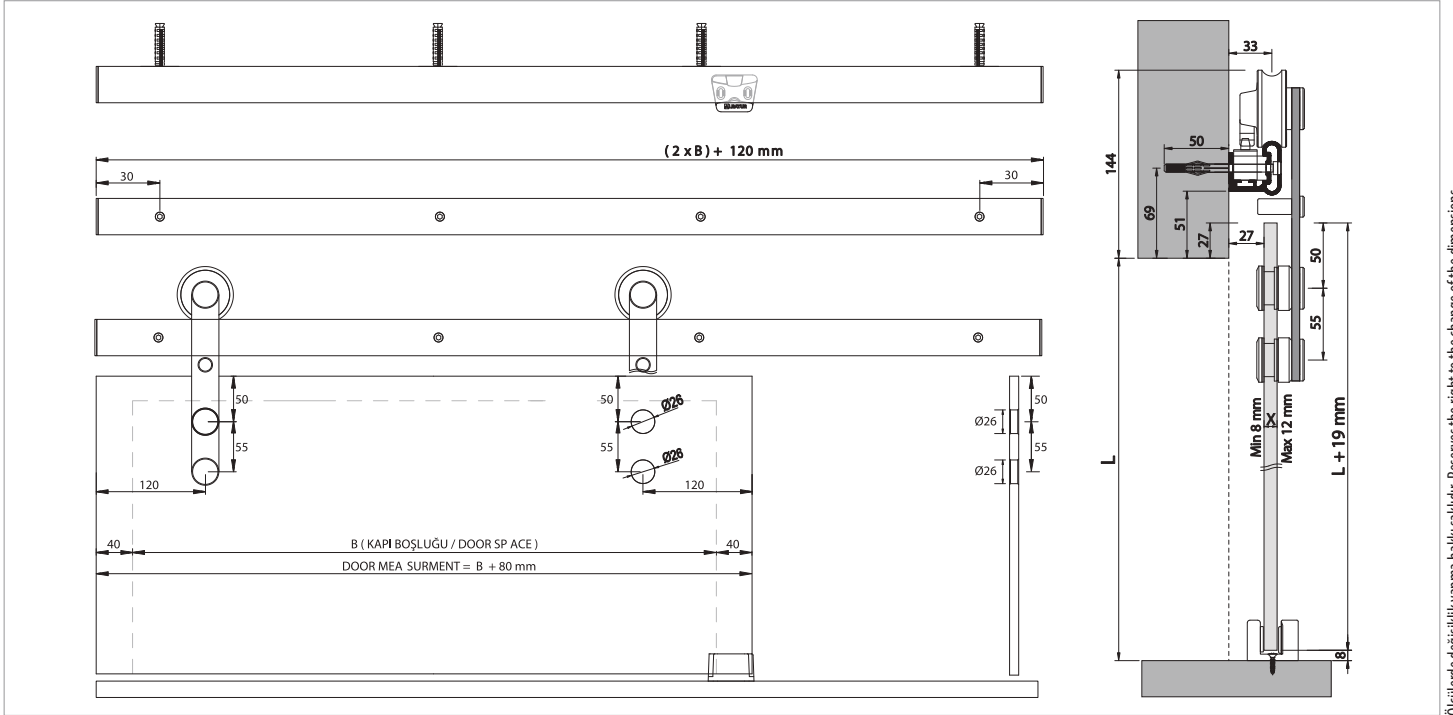

Ölçülerde değişiklik yapma hakkı saklıdır. Reserves the right to the change of the dimensions.

Uygulama / Application



SETBOX Paketleme / SETBOX Packaging



| Kod / Code No | Açıklama / Description | Renk / Colour | L (mm) | Birim / Unit | | |
|--------------------|---|---------------|----------|----------------|---|----|
| 119-8920-3430-1700 | Yavaşlatıcılı Sürme Cam Kapi Sistemi / Glass Sliding Door System (Soft Closing) | Siyah / Black | 1.700 mm | 1 Kapi / 1 Kit | 1 | 30 |
| 119-8920-3430-2000 | Yavaşlatıcılı Sürme Cam Kapi Sistemi / Glass Sliding Door System (Soft Closing) | Siyah / Black | 2.000 mm | 1 Kapi / 1 Kit | 1 | 30 |

BarnDoor 8810

ÜSTTEN ASKI AHŞAP SÜRME KAPI SİSTEMİ • TOP HANGER WOODEN SLIDING DOOR SYSTEM

Yeni Ürün
New Product



Bilgi / Information

- 2.300 - 2.600 - 2.900 - 3.200 - 3.500 mm özel boylar yapılmakta olup, her bir ürün 200 mm'ye kadar kısaltma yapılabilir.
- Special sizes Can be made 2.300 - 2.600 - 2.900 - 3.200 - 3.500 mm each product can be shortened up to 200 mm.



119-8810 1 Takım İçeriği / 1 Kit Includes

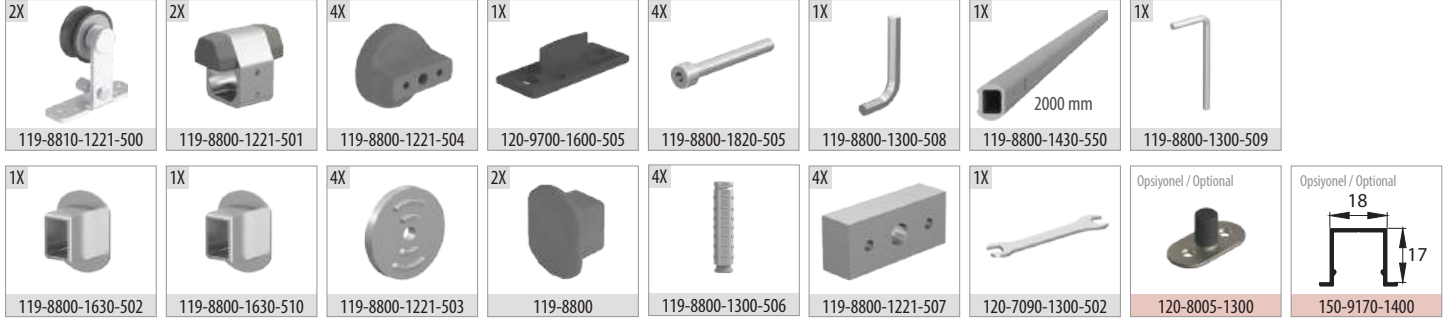

Teknik Detay / Technical Detail

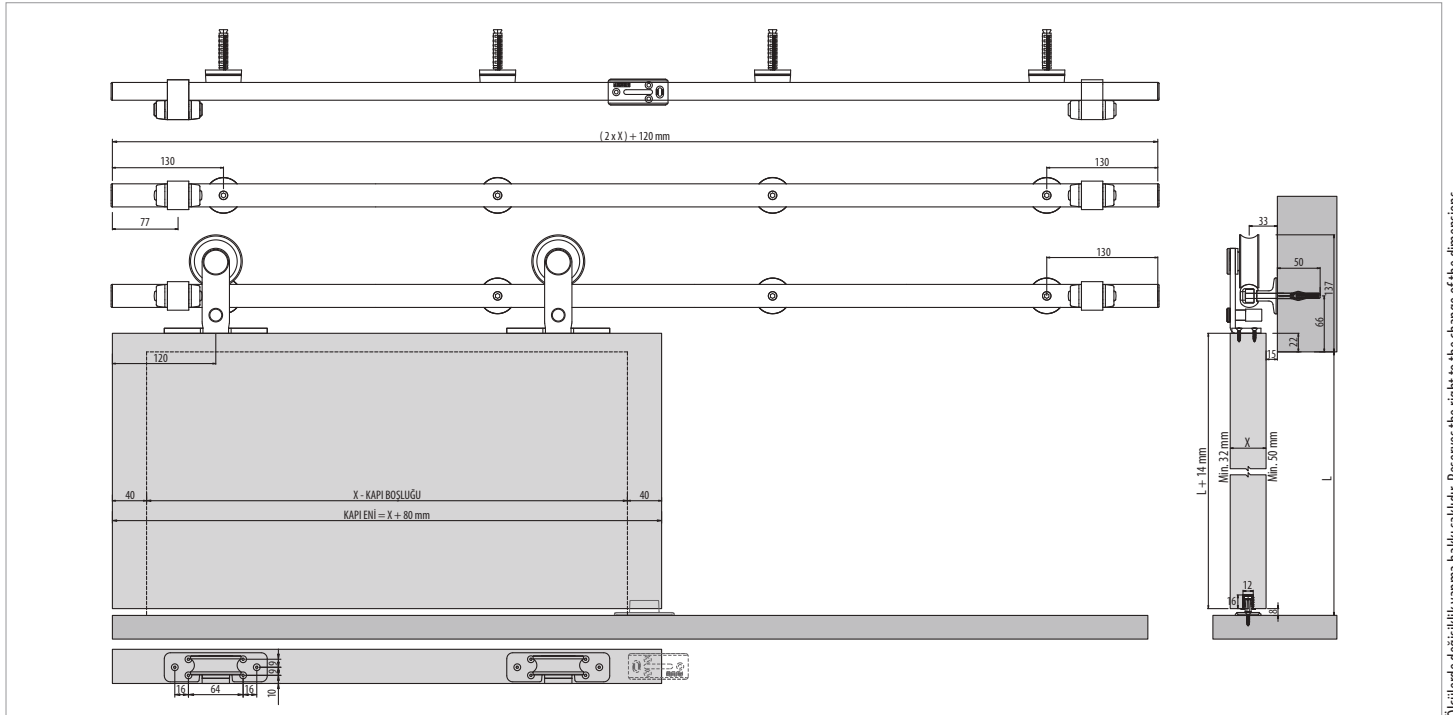

Ölçülerde değişiklik yapma hakkı saklıdır. Reserves the right to the change of the dimensions.

Uygulama / Application



SETBOX Paketleme / SETBOX Packaging

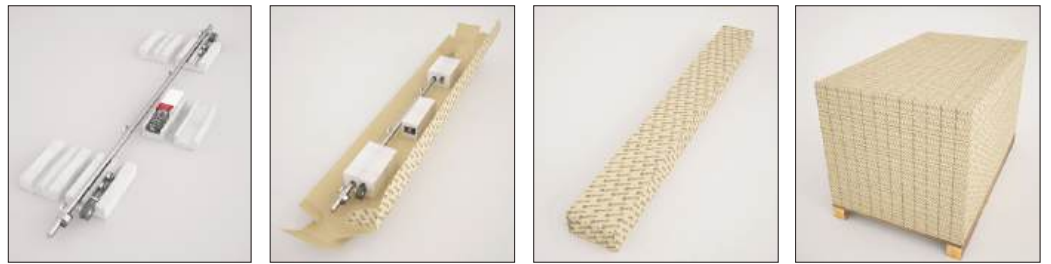

| Kod / Code No | Açıklama / Description | Renk / Colour | L (mm) | Birim / Unit | | |
|--------------------|--|---------------|----------|----------------|---|----|
| 119-8810-3430-1700 | Üstten Askı Sürme Kapi Sistemi / Top Hanger Sliding System | Siyah / Black | 1.700 mm | 1 Kapi / 1 Kit | 1 | 30 |
| 119-8810-3430-2000 | Üstten Askı Sürme Kapi Sistemi / Top Hanger Sliding System | Siyah / Black | 2.000 mm | 1 Kapi / 1 Kit | 1 | 30 |

BarnDoor 8830

80 KG ÇİFT YÖNE YAVAŞLATICILI SÜRME KAPI SİSTEMİ • SLIDING DOOR SYSTEM - TWO WAY SOFT CLOSING

Yeni Ürün
New Product



Bilgi / Information

- 2.500 - 3.000 - 3.500 - 4.000 mm özel boylar yapılmakta olup, özel boy ürünler 500 mm'ye kadar kısaltma yapılabilir.
- Special sizes Can be made 2.500 - 3.000 - 3.500 - 4.000 mm can be shortened up to 500 mm for special sizes.

Yavaşlatıcı Alternatifi / Soft Closer Alternative

- Sistem üzerinde entegre yavaşlatıcı mevcuttur.
- The system has integrated soft closer.



119-8830 1 Takım İçeriği / 1 Kit Includes

| | | | | |
|-----------------------------|-------------------------|---|---|--|
| 2X 119-8820-1221-500 | 1X 117-6995-1610-500 | 1X 119-8800-1300-506 | 1X 119-8820-1630-504 | 4X 119-8820-1300-503 |
| 1X 119-8820-1630-502 | 1X 120-7090-1300-502 | Opsiyonel / Optional 18 17 150-9170-1400 | Opsiyonel / Optional 119-8820-1221-506 | Opsiyonel / Optional <h2>Teknik Detay / Technical Detail</h2> |

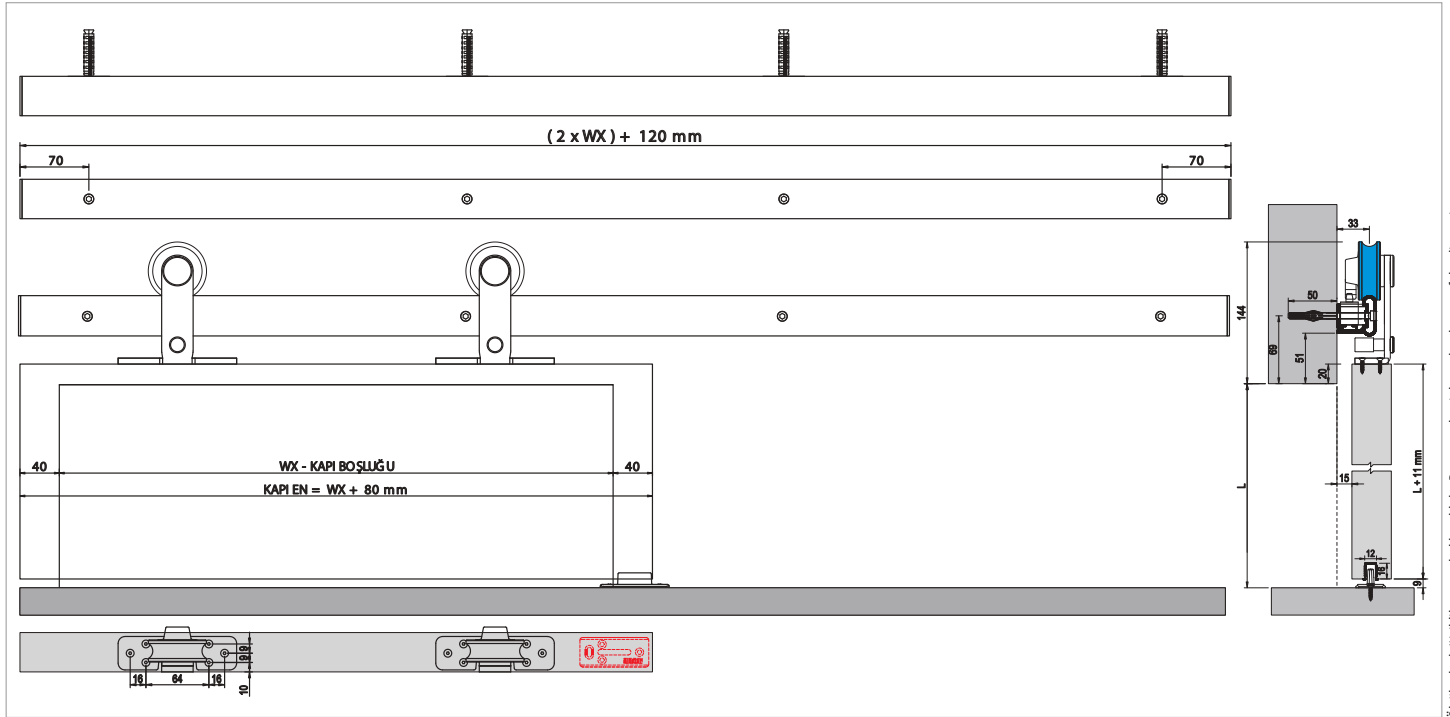

Özelliklerde değişiklik yapma hakkı saklıdır. Reserves the right to the change of the dimensions.

Uygulama / Application



SETBOX Paketleme / SETBOX Packaging



| Kod / Code No | Açıklama / Description | Renk / Colour | L (mm) | Birim / Unit | | |
|--------------------|---|---------------|----------|----------------|---|----|
| 119-8830-3430-1700 | 80 Kg Yavaşlatıcılı Sürme Kapi Sistemi / Sliding Door Has Soft Closing System | Siyah / Black | 1.700 mm | 1 Kapi / 1 Kit | 1 | 30 |
| 119-8830-3430-2000 | 80 Kg Yavaşlatıcılı Sürme Kapi Sistemi / Sliding Door Has Soft Closing System | Siyah / Black | 2.000 mm | 1 Kapi / 1 Kit | 1 | 30 |

Group 120

DoorSlide[®]

Ahşap Sürme Kapı Serisi

Wooden Sliding Door Series



Bu serideki tüm ürünleri incelemek için QR kodu okutabilirsiniz.

You can search the QR code to see all the products in these series.

DoorSlide

AHŞAP SÜRME KAPI SERİSİ • WOODEN SLIDING DOOR SERIES

Group **120**



DoorSlide **1000**



DoorSlide **9010**



DoorSlide **9015**



DoorSlide **9012**



DoorSlide **9020**



DoorSlide **9701**



DoorSlide **9706**



DoorSlide **9720**



DoorSlide **9725**



DoorSlide **7090**



DoorSlide **7099**



DoorSlide **7310**



DoorSlide **7340**



DoorSlide **7380**



DoorSlide **9600**



DoorSlide **9100**

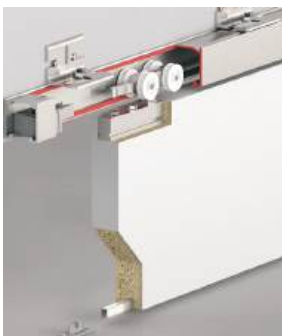

DoorSlide **9200**



DoorSlide **9700**



DoorSlide **9705**



DoorSlide **7120**

DoorSlide 1000

80 KG COPLANAR SÜRME KAPI SİSTEMİ • COPLANAR SLIDING DOOR SYSTEM

Yeni Ürün
New Product

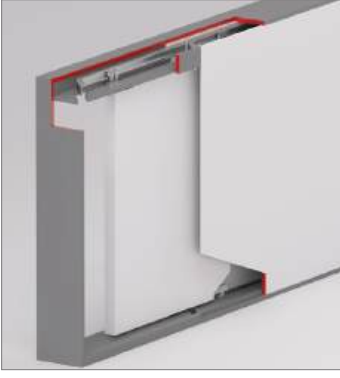

Bilgi / Information

- Kapı genişliği minimum 400 mm maksimum 1.500 mm olmalıdır.
• Door width min. 400 mm max. 1.500 mm
- Maksimum kapı yüksekliği 2.800 mm olmalıdır.
• Max. door height 2.800 mm



120-1000 1 Takım İçeriği / 1 Kit Includes



Teknik Detay / Technical Detail

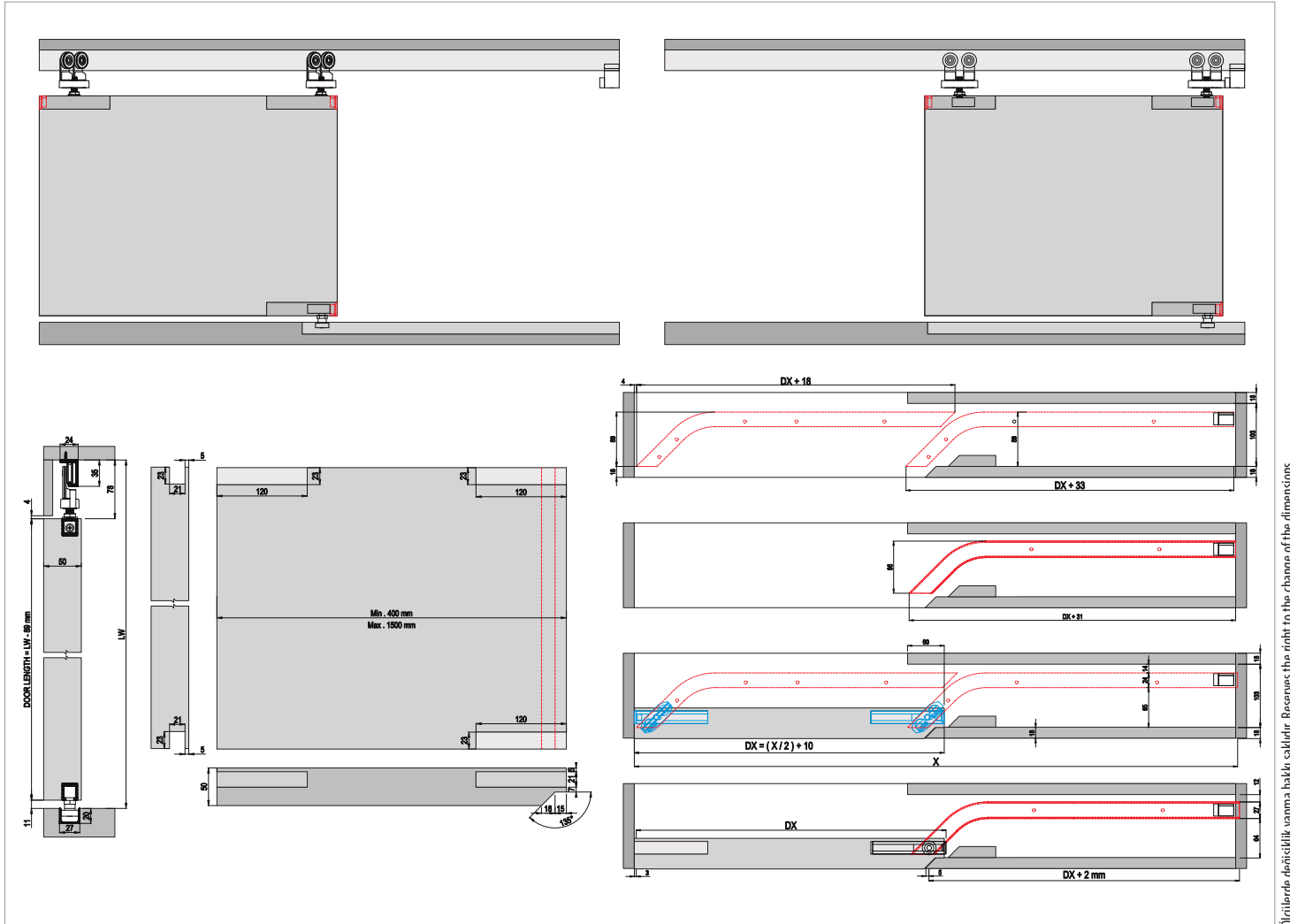

Ölçülerde değişiklik yapma hakkı saklıdır. Reserves the right to the change of the dimensions.

| Kod / Code No | Açıklama / Description | Renk / Colour | Birim / Unit | | |
|--------------------|--|----------------|----------------|---|----|
| 120-1000-3410-1500 | 80 Kg Coplanar Sürme Kapı Sistemi / Coplanar Sliding Door System | Bronz / Bronze | 1 Kapı / 1 Kit | 1 | 50 |

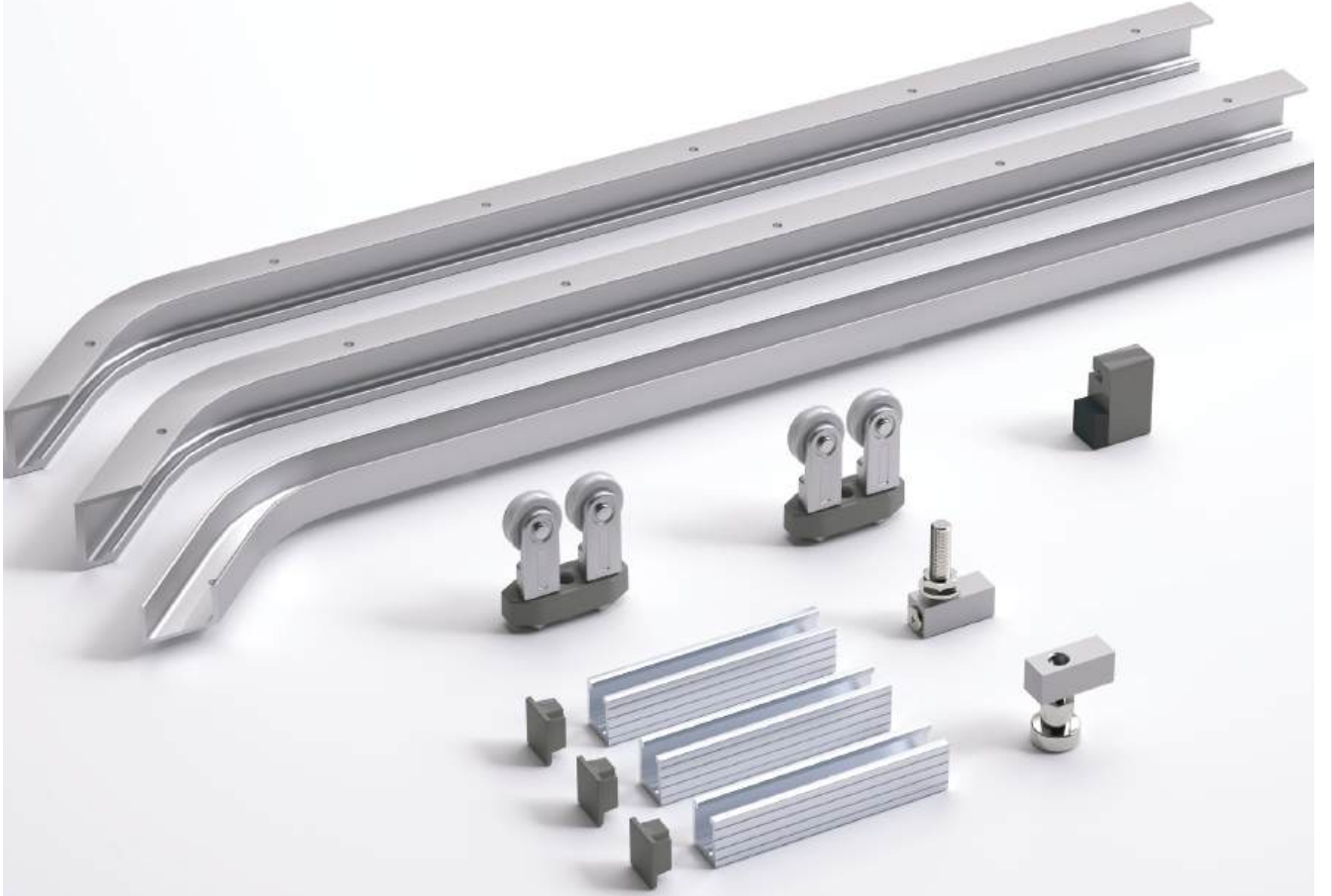

DoorSlide **1000**

AYARLI ÇİFT YÖNE YAVAŞLATICILI SÜRME KAPI SİSTEMİ • SLIDING DOOR SYSTEM - TWO WAY SOFT CLOSING

albaturas.com

DoorSlide 9010

60 KG AY. ÇİFT YÖNE YAVAŞLATICILI SÜRME KAPI SİSTEMİ • SLIDING DOOR SYSTEM - TWO WAY SOFT CLOSING



Bilgi / Information

- Minimum kapı genişliği 650 mm olmalıdır.
- Min. Door width 650 mm

Yavaşlatıcı Alternatifi / Soft Closer Alternative

- Sistem üzerinde çift yöne yavaşlatıcı mevcuttur.
- The system has two way soft closing.



120-9010 1 Takım İçeriği / 1 Kit Includes



Ray Profilleri / Rail Profiles

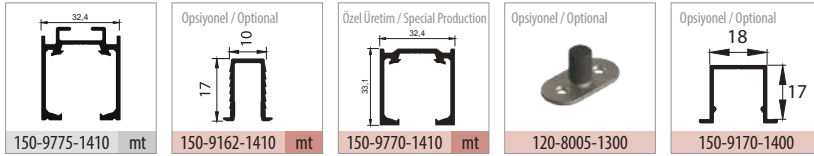

Uygulama / Application



* Duvar içi uygulamalarda, mekanizmanın hareketli teker bloğu sayesinde ray içi montajını kolaylaştırmaktadır.

* In wall Mounting application, its easy to fix in-rail installation through to movable roller block.

Teknik Detay / Technical Detail

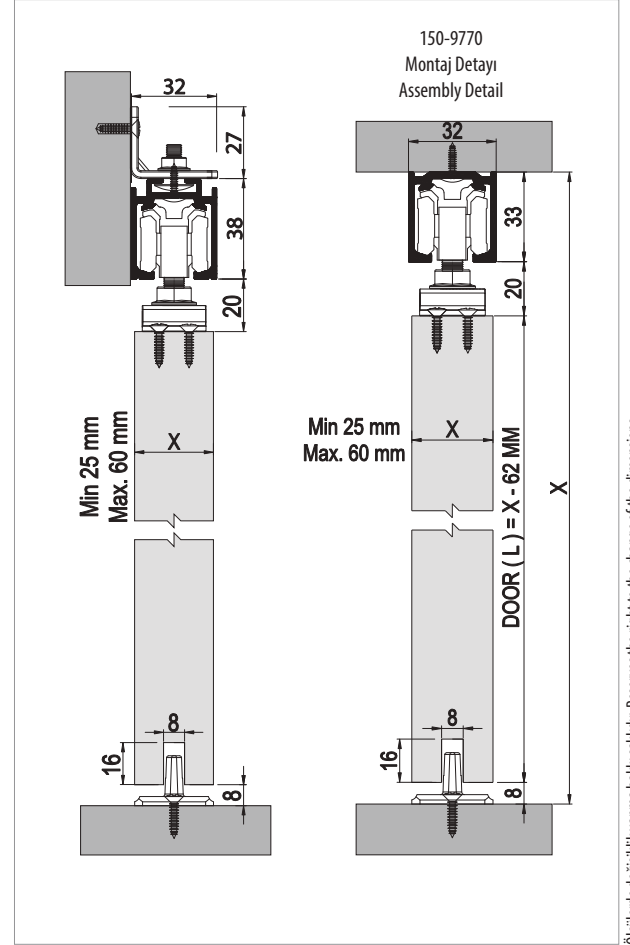

| Kod / Code No | Açıklama / Description | Renk / Colour | Birim / Unit | | | Profil mt. / Profiles mt. | Bağ / Bnd. |
|---------------|--|------------------------|----------------|----|-----|---------------------------|------------|
| 120-9010-1410 | 9010 SFT - 60 Kg Yavaş Sürme Kapı Sistemi / Sliding Door System - Soft Closing | Gri / Grey | 1 Kapı / 1 Kit | 12 | 576 | - | - |
| 150-9775-1410 | Alüminyum Üst Ray Profili / Aluminium Top Rail Profile | Eloksal / Mat Anodized | mt. | - | - | 2,0 | 3,0 |
| 150-9162-1410 | Alüminyum Alt Klavuz Profili / Aluminium Bottom Slider Profile | Eloksal / Mat Anodized | mt. | - | - | | 3,0 |

DoorSlide 9015

60 KG AY. ÇİFT YÖNE YAVAŞLATICILI SÜRME KAPI SİSTEMİ • SLIDING DOOR SYSTEM - TWO WAY SOFT CLOSING



Bilgi / Information

- Minimum kapı genişliği 650 mm olmalıdır.
- Min. Door width 650 mm

Yavaşlatıcı Alternatifi / Soft Closer Alternative

- Sistem üzerinde çift yöne yavaşlatıcı mevcuttur.
- The system has two way soft closing.



120-9015 1 Takım İçeriği / 1 Kit Includes



Ray Profilleri / Rail Profiles

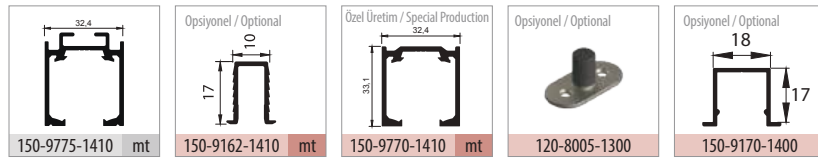

Uygulama / Application



* Duvar içi uygulamalarda, mekanizmanın hareketli teker bloğu sayesinde ray içi montajını kolaylaştırmaktadır.

* In wall Mounting application, its easy to fix in-rail installation through to movable roller block.

Teknik Detay / Technical Detail

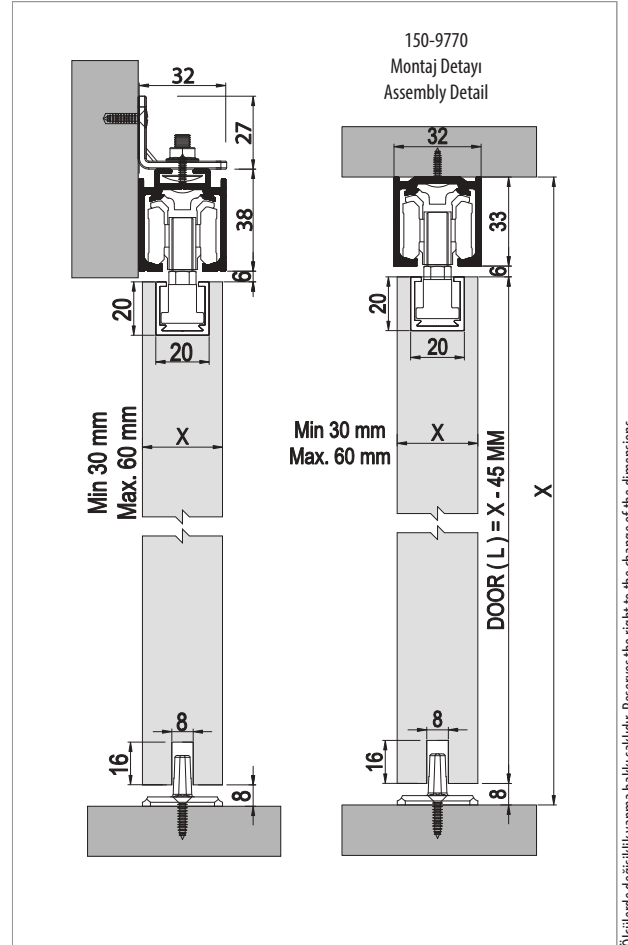

Ölçülerde değişiklik yapma hakkı saklıdır. Reserves the right to the change of the dimensions.

| Kod / Code No | Açıklama / Description | Renk / Colour | Birim / Unit | | | Profil mt. / Profiles mt. | Bağ / Bnd. |
|---------------|---|------------------------|----------------|----|-----|---------------------------|------------|
| 120-9015-1410 | 60 Kg Yavaşlatıcı Sürme Kapı Sistemi / Sliding Door System - Two Way Soft Closing | Gri / Grey | 1 Kapı / 1 Kit | 12 | 360 | - - - | - |
| 150-9775-1410 | Alüminyum Üst Ray Profili / Aluminium Top Rail Profile | Eloksal / Mat Anodized | mt. | - | - | 2,0 - 3,0 | 6 ad/pcs |
| 150-9162-1410 | Alüminyum Alt Klavuz Profili / Aluminium Bottom Slider Profile | Eloksal / Mat Anodized | mt. | - | - | - 3,0 | 20 ad/pcs |

DoorSlide 9012

60 KG AY. ÇİFT YÖNE YAVAŞLATICILI SÜRME KAPI SİSTEMİ • SLIDING DOOR SYSTEM - TWO WAY SOFT CLOSING

Özel Üretim
Special Production



Bilgi / Information

- Minimum kapı genişliği 610 mm olmalıdır.
- Min. Door width 610 mm

Yavaşlatıcı Alternatifi / Soft Closer Alternative

- Sistem üzerinde çift yöne yavaşlatıcı mevcuttur.
- The system has two way soft closing.



120-9012 1 Takım İçeriği / 1 Kit Includes



Ray Profilleri / Rail Profiles

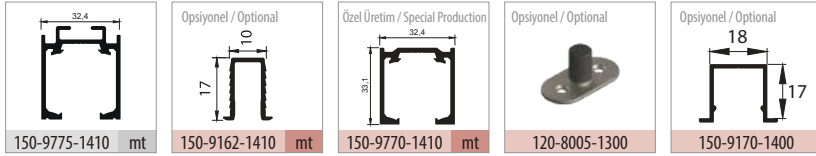

Uygulama / Application



* Duvar içi uygulamalarda, mekanizmanın hareketli teker bloğu sayesinde ray içi montajını kolaylaştırmaktadır.

* In wall Mounting application, its easy to fix in-rail installation through movable roller block.

Teknik Detay / Technical Detail

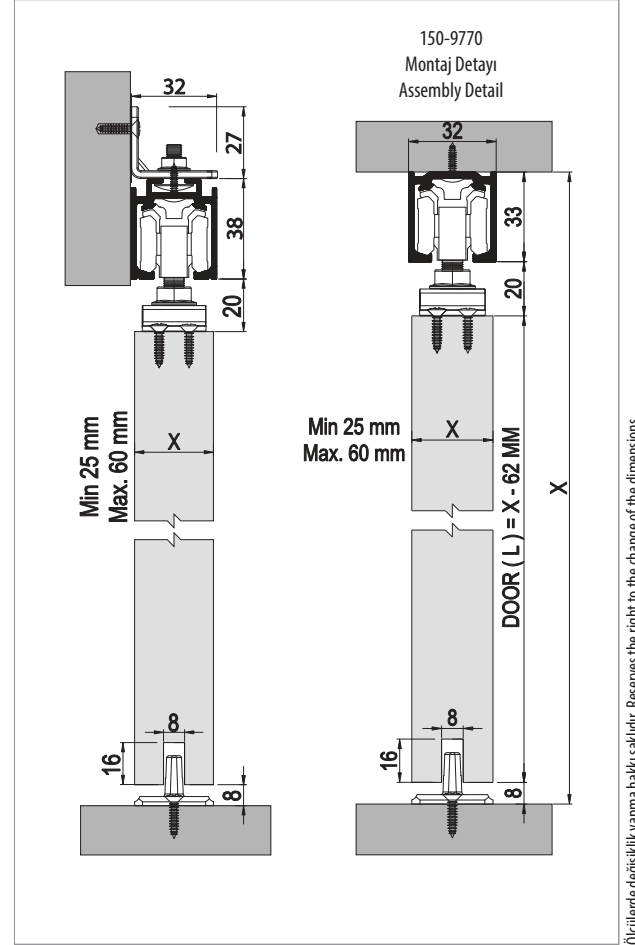

Ölçülerde değişiklik yapma hakkı saklıdır. Reserves the right to the change of the dimensions.

| Kod / Code No | Açıklama / Description | Renk / Colour | Birim / Unit | | | Profil mt. / Profiles mt. | Bağ / Bnd. |
|---------------|--|------------------------|----------------|----|-----|---------------------------|------------|
| 120-9012-1410 | 60 Kg Yavaş. Sürme Kapı Sistemi / Sliding Door System - Two Way Soft Closing | Gri / Grey | 1 Kapı / 1 Kit | 12 | 360 | - | - |
| 150-9775-1410 | Alüminyum Üst Ray Profili / Aluminium Top Rail Profile | Eloksal / Mat Anodized | mt. | - | - | 2,0 | 3,0 |
| 150-9162-1410 | Alüminyum Alt Klavuz Profili / Aluminium Bottom Slider Profile | Eloksal / Mat Anodized | mt. | - | - | - | 3,0 |

DoorSlide 9020

40 KG ÇİFT YÖNE YAVAŞLATICILI SÜRME KAPI SİSTEMİ • SLIDING DOOR SYSTEM - TWO WAY SOFT CLOSING



Bilgi / Information

- Minimum kapı genişliği 450 mm olmalıdır.
- Min. Door width 450 mm

Yavaşlatıcı Alternatifi / Soft Closer Alternative

- Sistem üzerinde çift yöne yavaşlatıcı mevcuttur.
- The system has two way soft closing.



120-9020 1 Takım İçeriği / 1 Kit Includes



Ray Profilleri / Rail Profiles

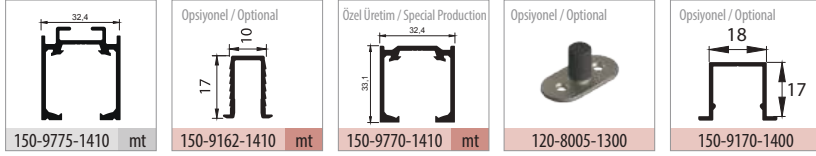

Uygulama / Application



* Duvar içi uygulamalarda, mekanizmanın hareketli teker bloğu sayesinde ray içi montajını kolaylaştırmaktadır.

* In wall Mounting application, its easy to fix in-rail installation through movable roller block.

Teknik Detay / Technical Detail

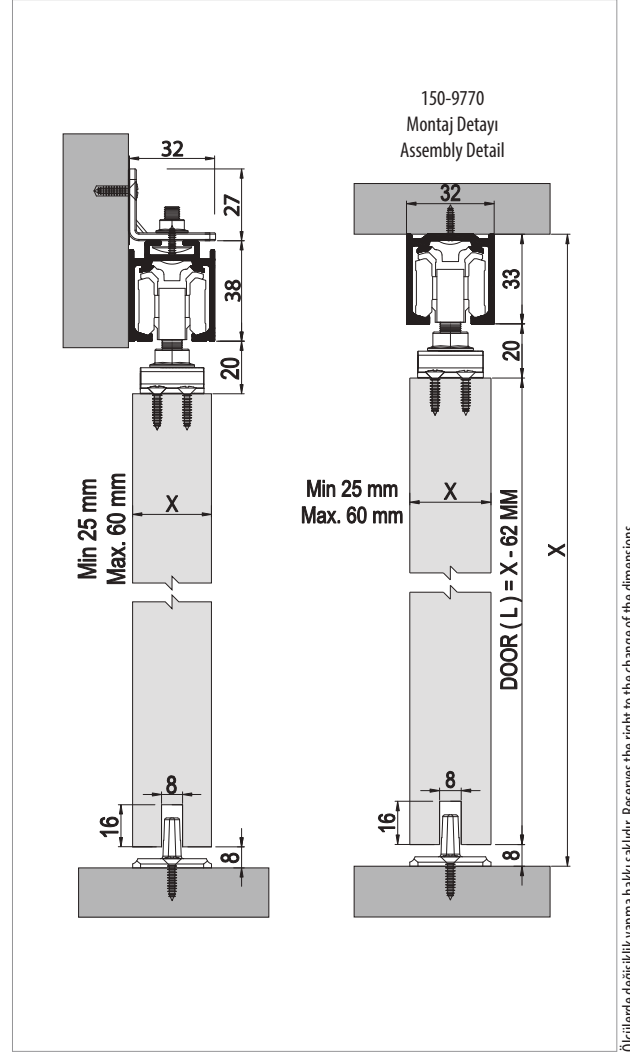

Ölçülerde değişiklik yapma hakkı saklıdır. Reserves the right to the change of the dimensions.

| Kod / Code No | Açıklama / Description | Renk / Colour | Birim / Unit | | | Profil mt. / Profiles mt. | Bağ / Bnd. |
|---------------|--|------------------------|----------------|----|-----|---------------------------|------------|
| 120-9020-1410 | 40 Kg Yavaş. Sürme Kapı Sistemi / Sliding Door System - Two Way Soft Closing | Gri / Grey | 1 Kapı / 1 Kit | 12 | 360 | - | - |
| 150-9775-1410 | Alüminyum Üst Ray Profili / Aluminium Top Rail Profile | Eloksal / Mat Anodized | mt. | - | - | 2,0 | 3,0 |
| 150-9162-1410 | Alüminyum Alt Klavuz Profili / Aluminium Bottom Slider Profile | Eloksal / Mat Anodized | mt. | - | - | - | 3,0 |

DoorSlide 9701

120 KG TEK YÖNE YAVAŞLATICILI SÜRGÜ KAPI SİSTEMİ • SLIDING DOOR SYSTEM - HAS SOFT CLOSING

9700 SFT



Bilgi / Information

- Minimum kapı genişliği 500 mm olmalıdır.
- Min. Door width 500 mm

Yavaşlatıcı Alternatifi / Soft Closer Alternative

- Sistem üzerinde tek yöne yavaşlatıcı mevcuttur.
- The system has one way soft closing.



120-9701 1 Takım İçeriği / 1 Kit Includes

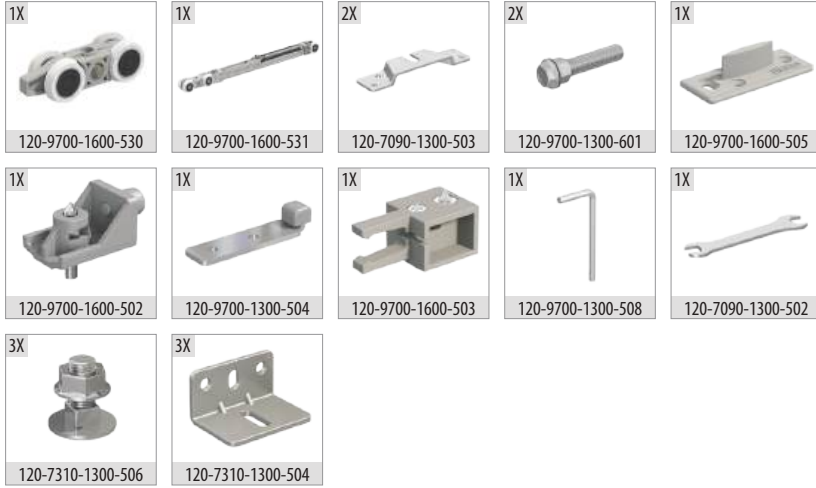

Ray Profilleri / Rail Profiles

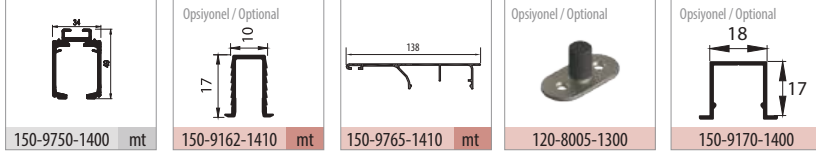

Uygulama / Application



Teknik Detay / Technical Detail

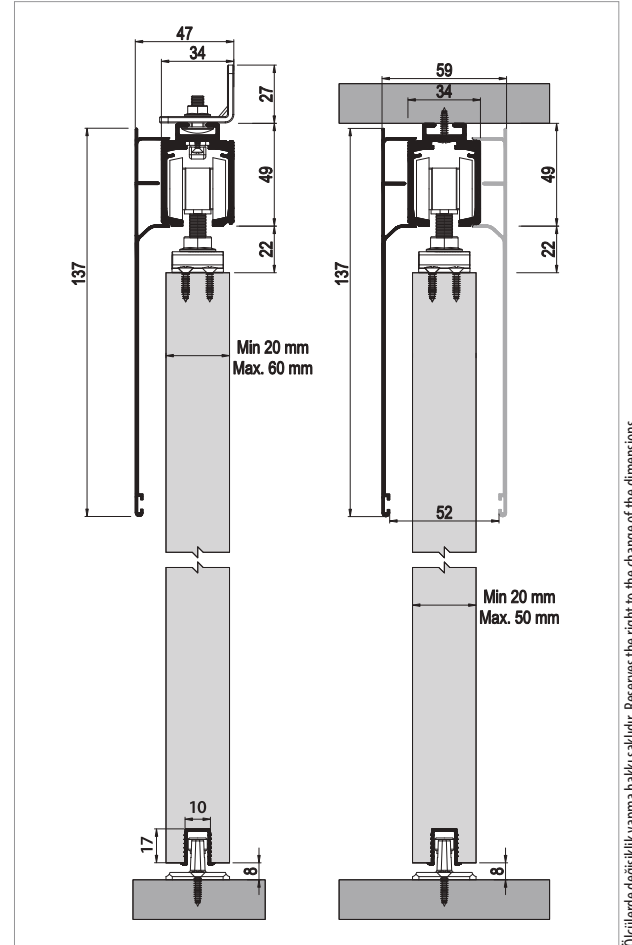

| Kod / Code No | Açıklama / Description | Renk / Colour | Birim / Unit | | | Profil mt. / Profiles mt. | Bağ / Bnd. |
|---------------|---|------------------------|----------------|----|-----|---------------------------|------------|
| 120-9701-1600 | 9700 SFT - 120 Kg Yavaşlatıcılı Sürgü Kapı Sistemi / Sliding Door System - Has Soft Closing | Gri / Grey | 1 Kapı / 1 Kit | 12 | 360 | - - - | - |
| 150-9750-1400 | Alüminyum Üst Ray Profili / Aluminium Top Rail Profile | Pres / Uncoated | mt. | - | - | 2,0 - 3,0 | 2 ad/pcs |
| 150-9162-1410 | Alüminyum Üst Klavuz Profili / Aluminium Bottom Slider Profile | Eloksal / Mat Anodized | mt. | - | - | - - 3,0 | 20 ad/pcs |
| 150-9765-1410 | Alüminyum Alın Kapama / Aluminium Cover Front | Eloksal / Mat Anodized | mt. | - | - | 2,0 - 3,0 | 2 ad/pcs |

DoorSlide 9706

120 KG TEK YÖNE YAVAŞLATICILI SÜRGÜ KAPI SİSTEMİ • SLIDING DOOR SYSTEM - HAS SOFT CLOSING

9705 SFT



Bilgi / Information

- Minimum kapı genişliği 500 mm olmalıdır.
- Min. Door width 500 mm

Yavaşlatıcı Alternatifi / Soft Closer Alternative

- Sistem üzerinde tek yöne yavaşlatıcı mevcuttur.
- The system has one way soft closing.



120-9706 1 Takım İçeriği / 1 Kit Includes

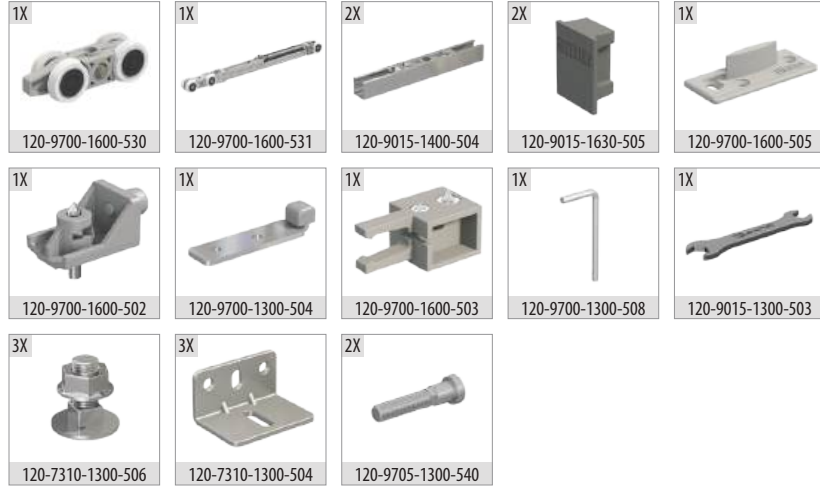

Ray Profilleri / Rail Profiles

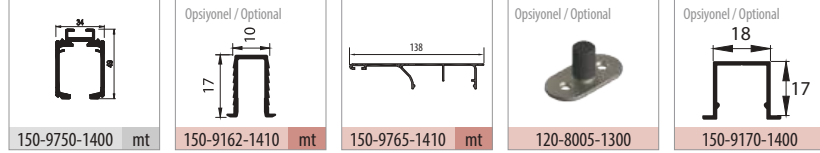

Uygulama / Application



Teknik Detay / Technical Detail

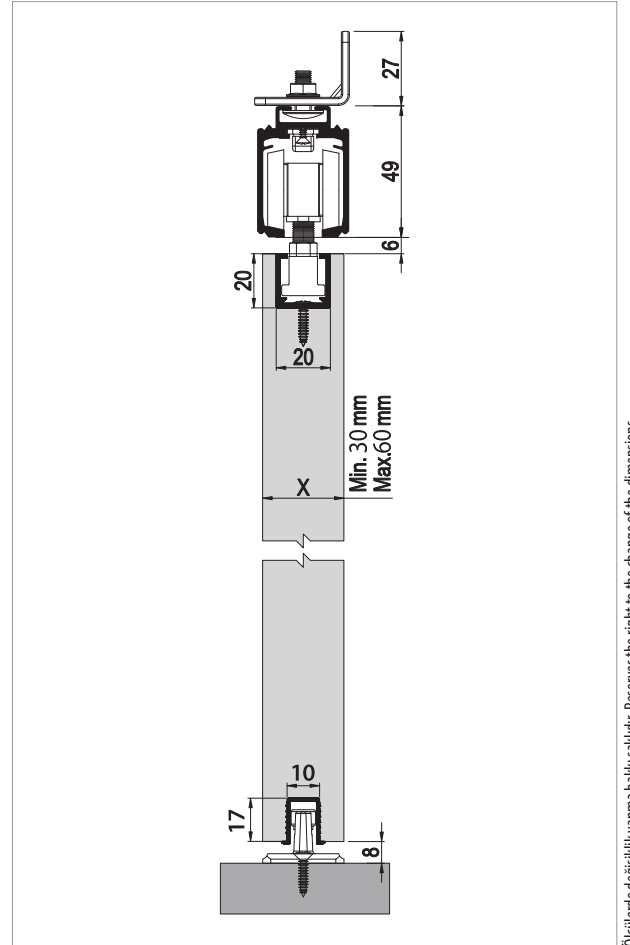

| Kod / Code No | Açıklama / Description | Renk / Colour | Birim / Unit | | | Profil mt. / Profiles mt. | Bağ / Bnd. | | |
|---------------|--|------------------------|----------------|---|-----|---------------------------|------------|-----|-----------|
| 120-9706-1600 | 120 Kg Yavaşlatıcılı Sürgü Kapı Sistemi / Sliding Door System - Has Soft Closing | Gri / Grey | 1 Kapı / 1 Kit | 8 | 400 | - | - | - | |
| 150-9750-1400 | Alüminyum Üst Ray Profili / Aluminium Top Rail Profile | Pres / Uncoated | mt. | - | - | 2,0 | - | 3,0 | 2 ad/pcs |
| 150-9162-1410 | Alüminyum Alt Klavuz Profili / Aluminium Bottom Slider Profile | Eloksal / Mat Anodized | mt. | - | - | - | - | 3,0 | 20 ad/pcs |
| 150-9765-1410 | Alüminyum Alın Kapama / Aluminium Cover Front | Eloksal / Mat Anodized | mt. | - | - | 2,0 | - | 3,0 | 2 ad/pcs |

DoorSlide 9720

120 KG ÇİFT YÖNE YAVAŞLATICILI SÜRGÜ KAPI SİSTEMİ • SLIDING DOOR SYSTEM - HAS SOFT CLOSING



Bilgi / Information

- Minimum kapı genişliği 830 mm olmalıdır.
- Min. Door width 830 mm

Yavaşlatıcı Alternatifi / Soft Closer Alternative

- Sistem üzerinde çift yöne yavaşlatıcı mevcuttur.
- The system has two way soft closing.



120-9720 1 Takım İçeriği / 1 Kit Includes

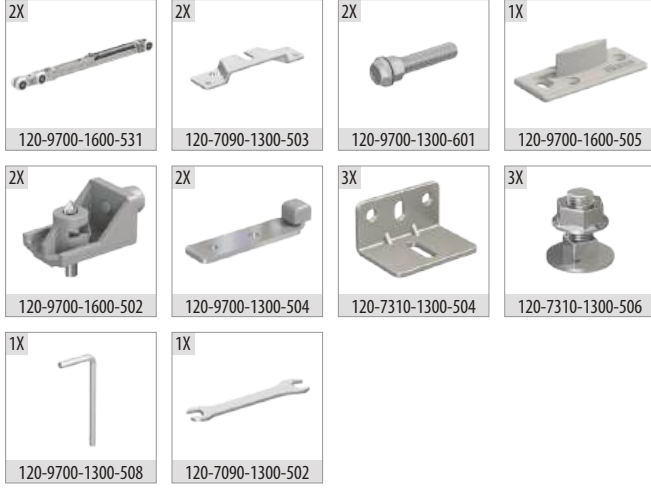

Ray Profilleri / Rail Profiles

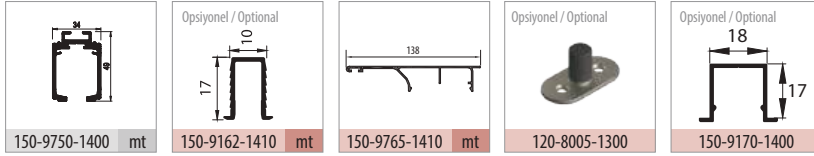

Uygulama / Application



Teknik Detay / Technical Detail

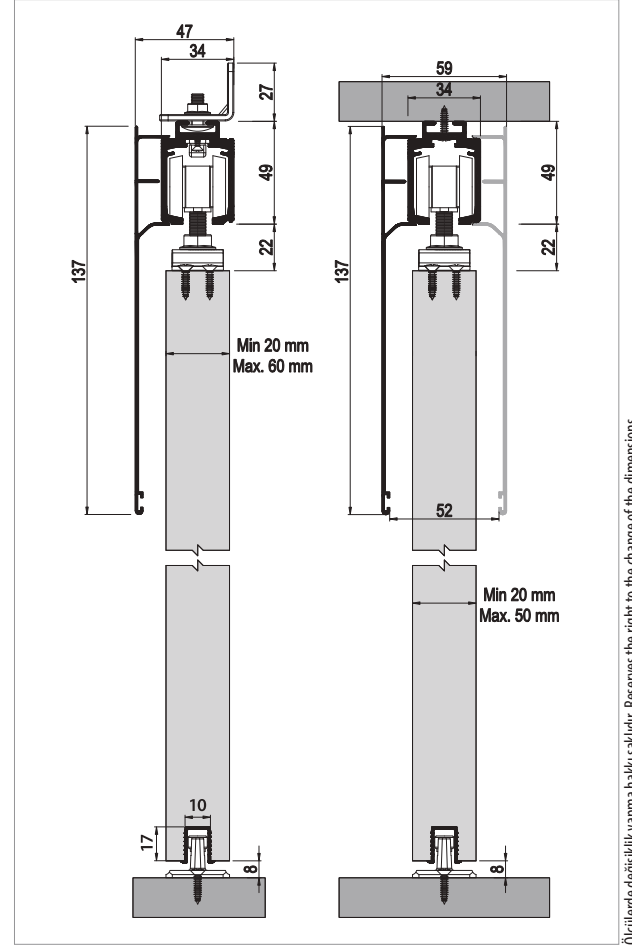

Ölçülerde değişiklik yapma hakkı saklıdır. Reserves the right to the change of the dimensions.

| Kod / Code No | Açıklama / Description | Renk / Colour | Birim / Unit | | | Profil mt. / Profiles mt. | Bağ / Bnd. |
|---------------|--|------------------------|----------------|---|-----|---------------------------|------------|
| 120-9720-1600 | 120 Kg Yavaşlatıcılı Sürgü Kapı Sistemi / Sliding Door System - Has Soft Closing | Gri / Grey | 1 Kapı / 1 Kit | 8 | 400 | - | - |
| 150-9750-1400 | Alüminyum Üst Ray Profili / Aluminium Top Rail Profile | Pres / Uncoated | mt. | - | - | 2,0 | 3,0 |
| 150-9162-1410 | Alüminyum Alt Klavuz Profili / Aluminium Bottom Slider Profile | Eloksal / Mat Anodized | mt. | - | - | - | 3,0 |
| 150-9765-1410 | Alüminyum Alın Kapama / Aluminium Cover Front | Eloksal / Mat Anodized | mt. | - | - | 2,0 | 3,0 |

DoorSlide 9725

120 KG ÇİFT YÖNE YAVAŞLATICILI SÜRGÜ KAPI SİSTEMİ - SLIDING DOOR SYSTEM - HAS SOFT CLOSING



Bilgi / Information

- Minimum kapı genişliği 830 mm olmalıdır.
- Min. Door width 830 mm

Yavaşlatıcı Alternatifi / Soft Closer Alternative

- Sistem üzerinde çift yöne yavaşlatıcı mevcuttur.
- The system has two way soft closing.



120-9725 1 Takım İçeriği / 1 Kit Includes



Ray Profilleri / Rail Profiles

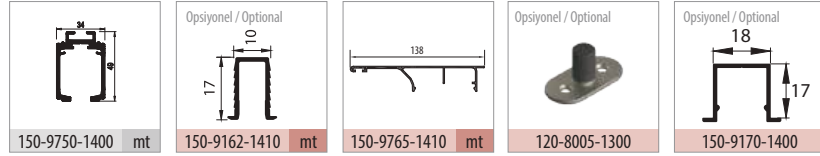

Uygulama / Application



Teknik Detay / Technical Detail

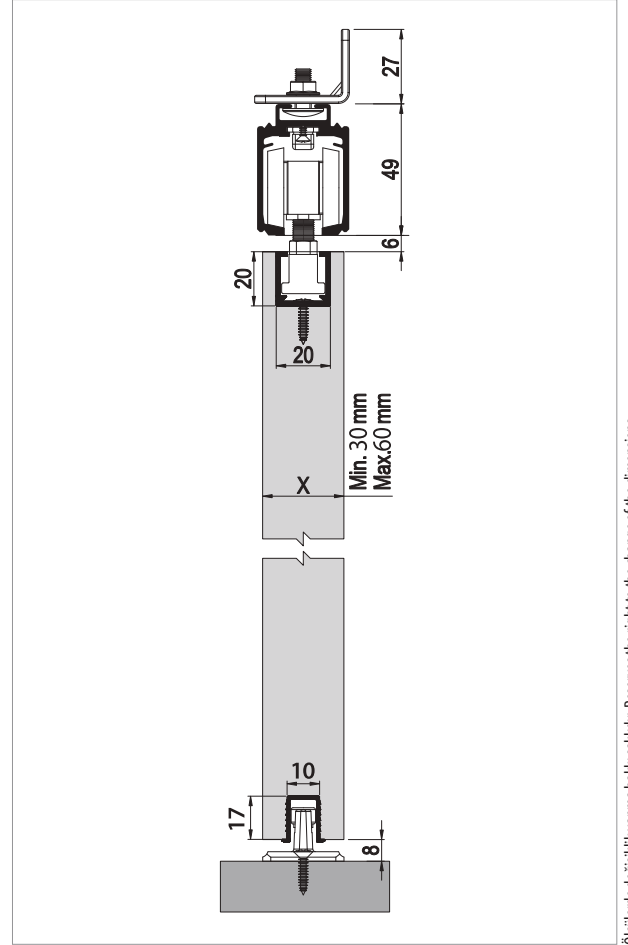

Ölçülerde değişiklik yapma hakkı saklıdır. Reserves the right to the change of the dimensions.

| Kod / Code No | Açıklama / Description | Renk / Colour | Birim / Unit | | | Profil mt. / Profiles mt. | Bağ / Bnd. |
|---------------|--|------------------------|----------------|---|-----|---------------------------|------------|
| 120-9725-1600 | 120 Kg Yavaşlatıcılı Sürgü Kapı Sistemi / Sliding Door System - Has Soft Closing | Gri / Grey | 1 Kapı / 1 Kit | 8 | 400 | - - - | - |
| 150-9750-1400 | Alüminyum Üst Ray Profili / Aluminium Top Rail Profile | Pres / Uncoated | mt. | - | - | 2,0 - 3,0 | 2 ad/pcs |
| 150-9162-1410 | Alüminyum Alt Klavuz Profili / Aluminium Bottom Slider Profile | Eloksal / Mat Anodized | mt. | - | - | - - 3,0 | 20 ad/pcs |
| 150-9765-1410 | Alüminyum Alın Kapama / Aluminium Cover Front | Eloksal / Mat Anodized | mt. | - | - | 2,0 - 3,0 | 2 ad/pcs |

DoorSlide 7090

80 KG SÜRGÜLÜ KAPI SİSTEMİ • SLIDING DOOR SYSTEM



120-7090 1 Takım İçeriği / 1 Kit Includes



Ray Profilleri / Rail Profiles

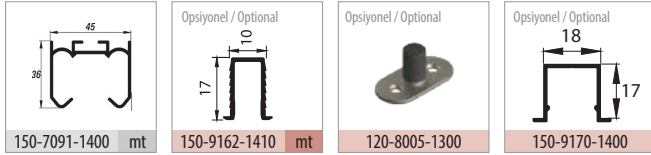

Uygulama / Application



Teknik Detay / Technical Detail

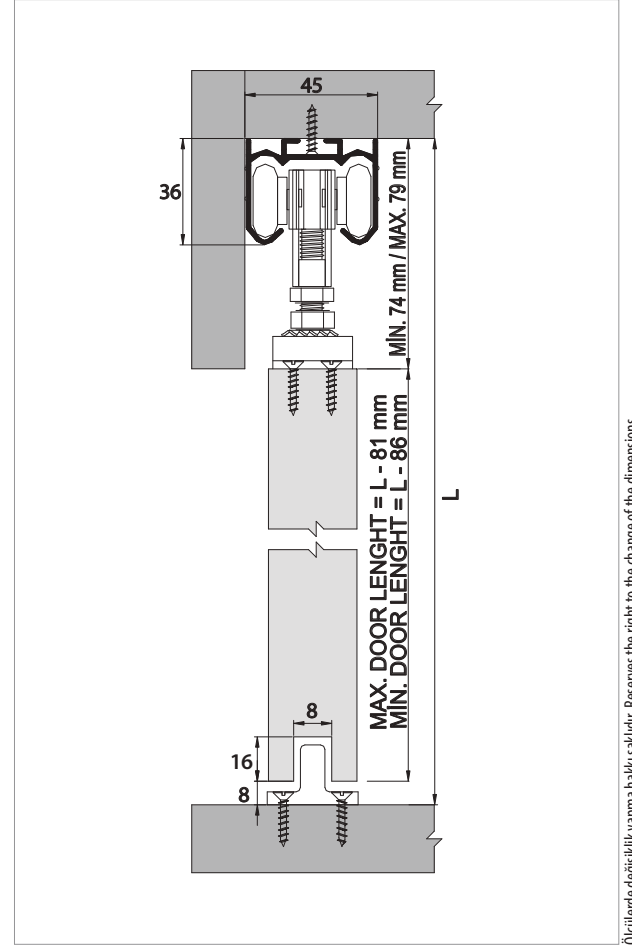

Ölçülerde değişiklik yapma hakkı saklıdır. Reserves the right to the change of the dimensions.

| Kod / Code No | Açıklama / Description | Renk / Colour | Birim / Unit | | | Profil mt. / Profiles mt. | | | Bağ / Bnd. |
|---------------|--|------------------------|----------------|----|-----|---------------------------|---|-----|------------|
| 120-7090-1320 | 80 Kg Sürgü Kapı Sistemi / Sliding Door System | Galvaniz / Galvanized | 1 Kapı / 1 Kit | 24 | 576 | - | - | - | - |
| 150-7091-1400 | Alüminyum Üst Ray Profili / Aluminium Top Rail Profile | Pres / Uncoated | mt. | - | - | 2,0 | - | 3,0 | 6 ad/pcs |
| 150-9162-1410 | Alüminyum Alt Klavuz Profili / Aluminium Bottom Slider Profile | Eloksal / Mat Anodized | mt. | - | - | - | - | 3,0 | 20 ad/pcs |

DoorSlide 7099

80 KG SÜRGÜLÜ KAPI SİSTEMİ RULMANLI • SLIDING DOOR SYSTEM HAS BALL BEARING



120-7099 1 Takım İçeriği / 1 Kit Includes



Ray Profilleri / Rail Profiles

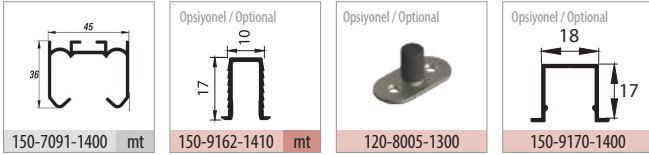

Uygulama / Application



Teknik Detay / Technical Detail

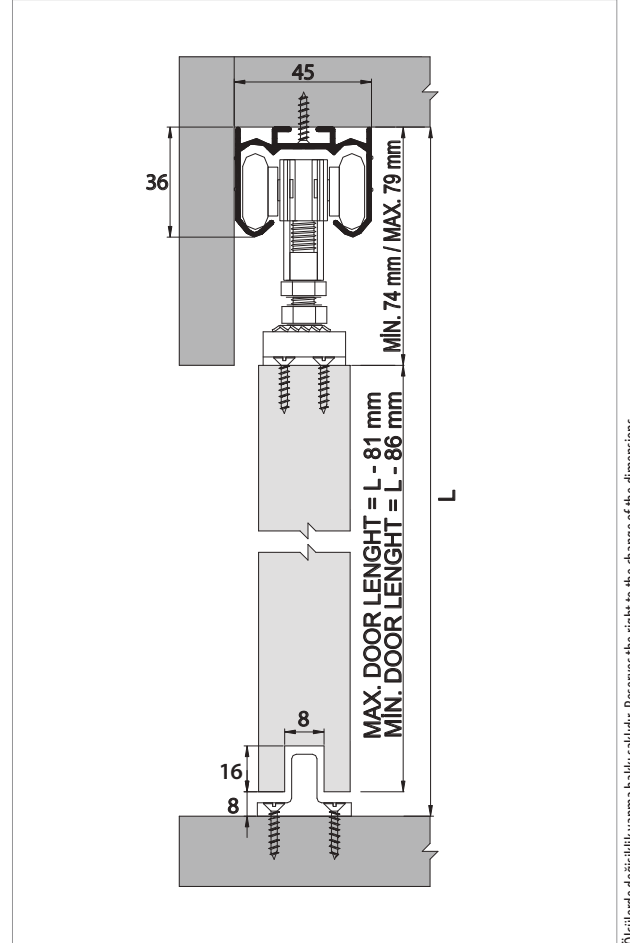

Ölçülerde değişiklik yapma hakkı saklıdır. Reserves the right to the change of the dimensions.

| Kod / Code No | Açıklama / Description | Renk / Colour | Birim / Unit | | | Profil mt. / Profiles mt. | Bağ / Bnd. |
|---------------|--|------------------------|----------------|----|-----|---------------------------|------------|
| 120-7099-1320 | 80 Kg Sürgü Kapa Sistemi / Sliding Door System | Galvaniz / Galvanized | 1 Kapı / 1 Kit | 24 | 576 | - | - |
| 150-7091-1400 | Alüminyum Üst Ray Profili / Aluminium Top Rail Profile | Pres / Uncoated | mt. | - | - | 2,0 | 3,0 |
| 150-9162-1410 | Alüminyum Alt Klavuz Profili / Aluminium Bottom Slider Profile | Eloksal / Mat Anodized | mt. | - | - | - | 3,0 |

DoorSlide 7310

51 KG SÜRGÜLÜ KAPI SİSTEMİ • SLIDING DOOR SYSTEM



120-7310 1 Takım İçeriği / 1 Kit Includes



Ray Profilleri / Rail Profiles

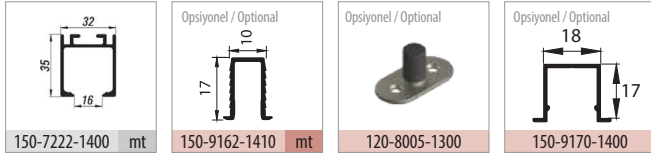

Uygulama / Application



Teknik Detay / Technical Detail

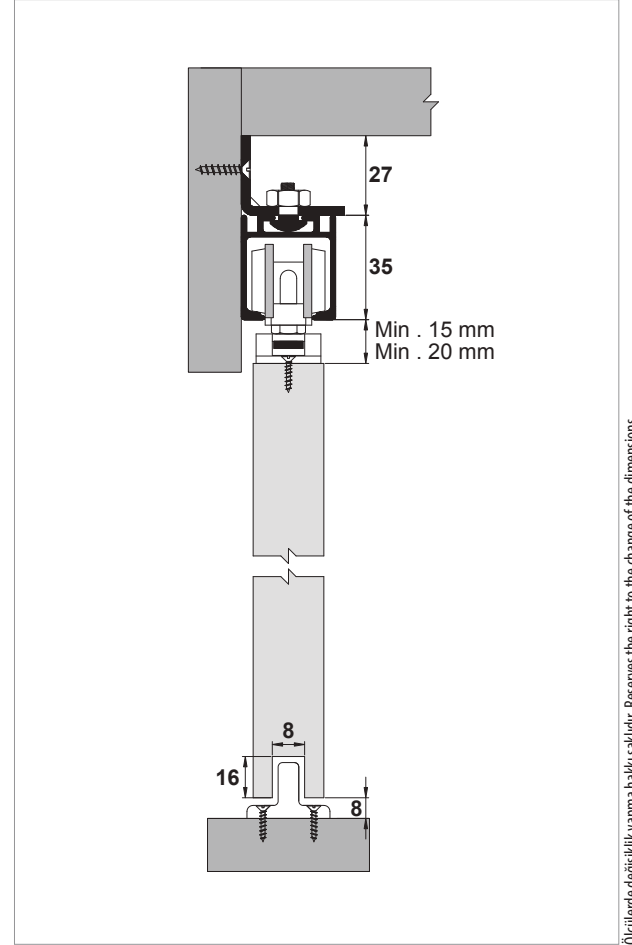

| Kod / Code No | Açıklama / Description | Renk / Colour | Birim / Unit | | | Profil mt. / Profiles mt. | Bağ / Bnd. |
|---------------|--|------------------------|----------------|----|-----|---------------------------|------------|
| 120-7310-1600 | 51 Kg Sürgülü Kapı Sistemi / Sliding Door System | Gri / Grey | 1 Kapı / 1 Kit | 24 | 768 | - | - |
| 150-7222-1400 | Alüminyum Üst Ray Profili / Aluminium Top Rail Profile | Pres/ Uncoated | mt. | - | - | 2,0 | 3,0 |
| 150-9162-1410 | Alüminyum Alt Klavuz Profili / Aluminium Bottom Slider Profile | Eloksal / Mat Anodized | mt. | - | - | - | 3,0 |

DoorSlide 7340

60 KG SÜRGÜLÜ KAPI SİSTEMİ - SLIDING DOOR SYSTEM



120-7340 1 Takım İçeriği / 1 Kit Includes



Ray Profilleri / Rail Profiles

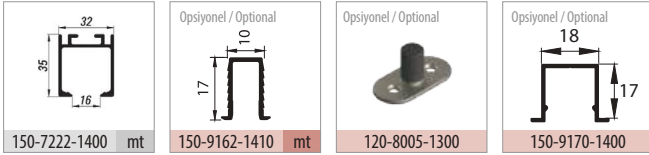

Uygulama / Application



Teknik Detay / Technical Detail

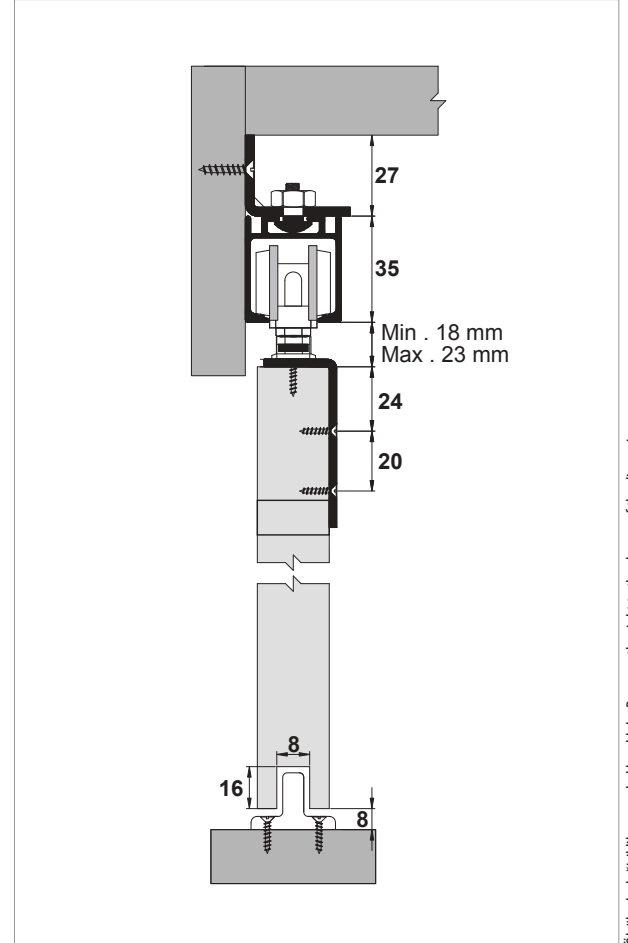

Ölçülerde değişiklik yapma hakkı saklıdır. Reserves the right to the change of the dimensions.

| Kod / Code No | Açıklama / Description | Renk / Colour | Birim / Unit | | | Profil mt. / Profiles mt. | Bağ / Bnd. | | |
|---------------|--|------------------------|----------------|----|-----|---------------------------|------------|-----|-----------|
| 120-7340-1300 | 60 Kg Sürgülü Kapı Sistemi / Sliding Door System | Gri / Grey | 1 Kapı / 1 Kit | 24 | 768 | - | - | - | |
| 150-7222-1400 | Alüminyum Üst Ray Profili / Aluminium Top Rail Profile | Pres / Uncoated | mt. | - | - | 2,0 | - | 3,0 | 6 ad/pcs |
| 150-9162-1410 | Alüminyum Alt Klavuz Profili / Aluminium Bottom Slider Profile | Eloksal / Mat Anodized | mt. | - | - | - | - | 3,0 | 20 ad/pcs |

DoorSlide 7380

80 KG SÜRGÜLÜ KAPI SİSTEMİ RULMANLI • SLIDING DOOR SYSTEM HAS BALL BEARING



120-7380 1 Takım İçeriği / 1 Kit Includes

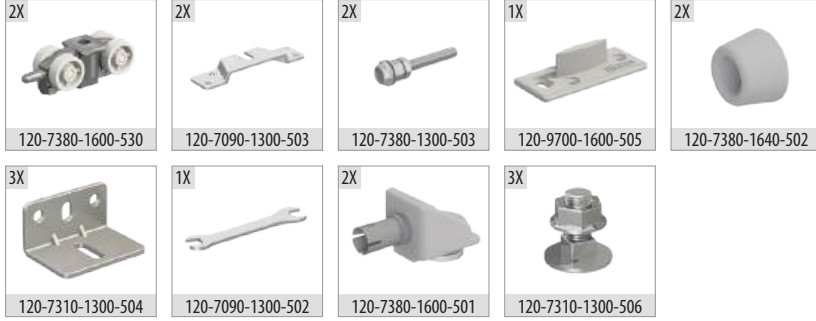

Ray Profilleri / Rail Profiles

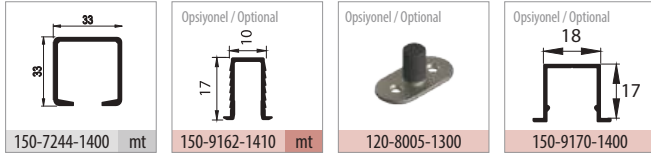

Uygulama / Application



Teknik Detay / Technical Detail

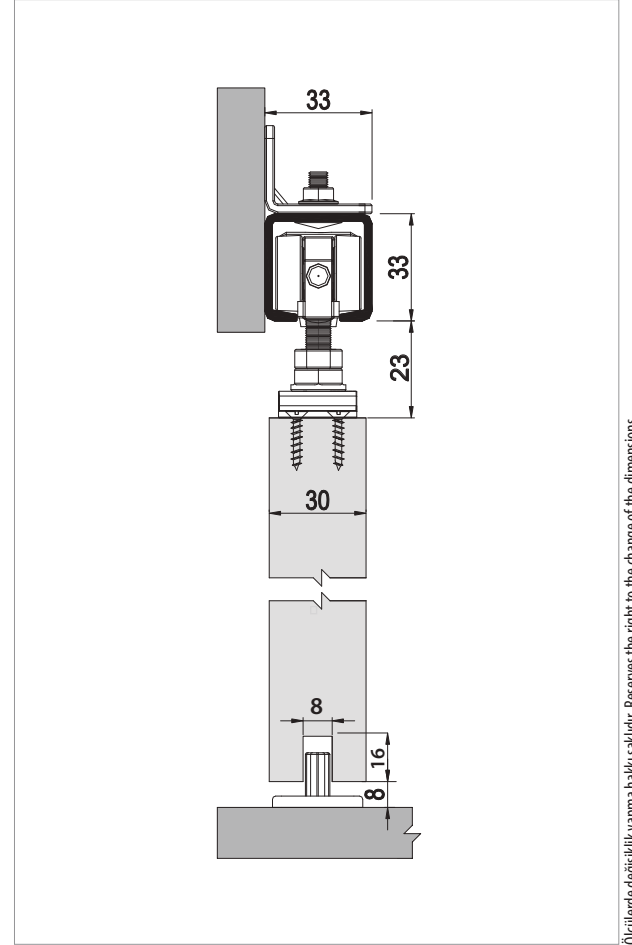

Ölçülerde değişiklik yapma hakkı saklıdır. Reserves the right to the change of the dimensions.

| Kod / Code No | Açıklama / Description | Renk / Colour | Birim / Unit | | | Profil mt. / Profiles mt. | | | Bağ / Bnd. |
|---------------|--|------------------------|----------------|----|-----|---------------------------|---|-----|------------|
| 120-7380-1600 | 80 Kg Sürgülü Kapı Sistemi / Sliding Door System | Gri / Grey | 1 Kapı / 1 Kit | 24 | 768 | - | - | - | - |
| 150-7244-1400 | Alüminyum Üst Ray Profili / Aluminium Top Rail Profile | Pres / Uncoated | mt. | - | - | 2,0 | - | 3,0 | 6 ad/pcs |
| 150-9162-1410 | Alüminyum Alt Klavuz Profili / Aluminium Bottom Slider Profile | Eloksal / Mat Anodized | mt. | - | - | - | - | 3,0 | 20 ad/pcs |

DoorSlide 9600

160 KG SÜRGÜLÜ KAPI SİSTEMİ • SLIDING DOOR SYSTEM



120-9600 1 Takım İçeriği / 1 Kit Includes



Ray Profilleri / Rail Profiles

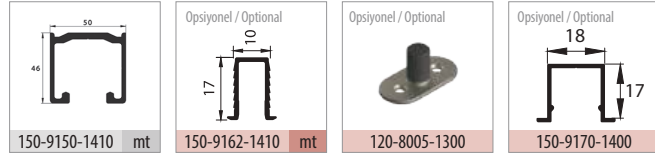

Uygulama / Application



Teknik Detay / Technical Detail

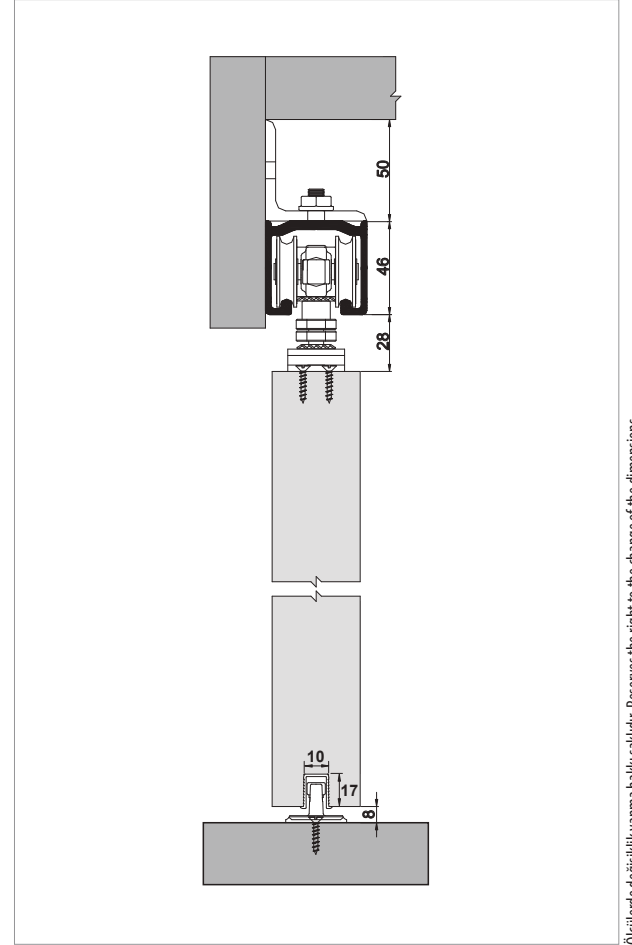

Ölçülerde değişiklik yapma hakkı saklıdır. Reserves the right to the change of the dimensions.

| Kod / Code No | Açıklama / Description | Renk / Colour | Birim / Unit | | | Profil mt. / Profiles mt. | | | Bağ / Bnd. |
|-------------------|--|------------------------|----------------|----|-------|---------------------------|---|-----|------------|
| 120-9600-1300 | 160 Kg Sürgü Kapi Sistemi / Sliding Door System | Gri / Grey | 1 Kapi / 1 Kit | 16 | 512 | - | - | - | - |
| 120-9100-1300-504 | Askı Aparatı / Hanger Parts | Galvaniz / Galvanized | 1 Adet / 1 Pcs | 50 | 2.400 | - | - | - | - |
| 150-9150-1410 | Alüminyum Üst Ray Profili / Aluminium Top Rail Profile | Eloksal / Mat Anodized | mt. | - | - | 2,0 | - | 3,0 | 2 ad/pcs |
| 150-9162-1410 | Alüminyum Alt Klavuz Profili / Aluminium Bottom Slider Profile | Eloksal / Mat Anodized | mt. | - | - | - | - | 3,0 | 20 ad/pcs |

DoorSlide 9100

250 KG SÜRGÜLÜ KAPI SİSTEMİ • SLIDING DOOR SYSTEM



Bilgi / Information

- Minimum kapı panel kalınlığı 40 mm. olmalıdır.
- Door panel's thickness should be minimum 40 mm.



120-9100 1 Takım İçeriği / 1 Kit Includes



Ray Profilleri / Rail Profiles

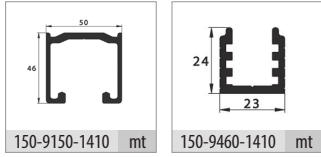

Opsiyonel Aksesuar / Optional Accessories



Uygulama / Application



Teknik Detay / Technical Detail

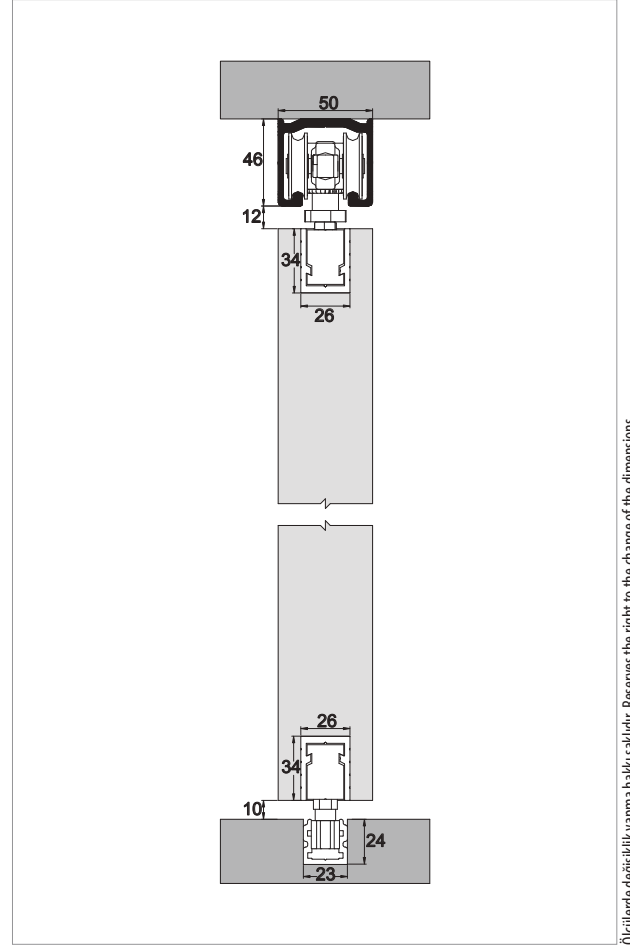

Ölçülerde değişiklik yapma hakkı saklıdır. Reserves the right to the change of the dimensions.

| Kod / Code No | Açıklama / Description | Renk / Colour | Birim / Unit | | | Profil mt. / Profiles mt. | Bağ / Bnd. |
|-------------------|---|------------------------|----------------|----|-------|---------------------------|------------|
| 120-9100-1300 | 250 Kg Sürgü Kapı Sistemi / Sliding Door System | Grİ / Grey | 1 Kapı / 1 Kit | 12 | 360 | - - - | - |
| 120-9100-1300-504 | Askı Aparatı / Hanger Parts | Galvaniz / Galvanized | 1 Adet / 1 Pcs | 50 | 2.400 | - - - | - |
| 150-9150-1410 | Alüminyum Üst Ray Profili / Aluminium Top Rail Profile | Eloksal / Mat Anodized | mt. | - | - | 2,0 - 3,0 | 2 ad/pcs |
| 150-9460-1410 | Alüminyum Alt Ray Profili / Aluminium Bottom Rail Profile | Eloksal / Mat Anodized | mt. | - | - | 2,0 - 3,0 | 8 ad/pcs |

DoorSlide 9200

250 KG SÜRGÜLÜ KAPI SİSTEMİ • SLIDING DOOR SYSTEM



Bilgi / Information

- Minimum kapı panel kalınlığı 40 mm. olmalıdır.
- Door panel's thickness should be minimum 40 mm.



120-9200 1 Takım İçeriği / 1 Kit Includes



Ray Profilleri / Rail Profiles

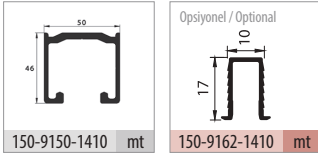

Opsiyonel Aksesuar / Optional Accessories



Uygulama / Application



Teknik Detay / Technical Detail

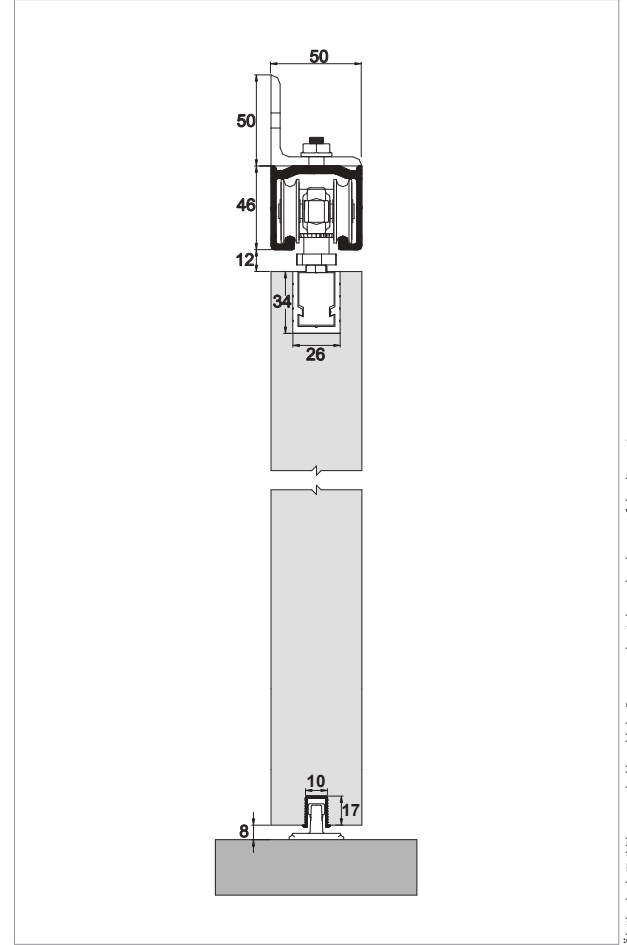

Ölçülerde değişiklik yapma hakkı saklıdır. Reserves the right to the change of the dimensions.

| Kod / Code No | Açıklama / Description | Renk / Colour | Birim / Unit | | | Profil mt. / Profiles mt. | | | Bağ / Bnd. |
|-------------------|--|------------------------|----------------|----|-------|---------------------------|---|-----|------------|
| 120-9200-1300 | 250 Kg Sürgülü Kapı Sistemi / Sliding Door System | Gri / Grey | 1 Kapı / 1 Kit | 12 | 360 | - | - | - | - |
| 120-9100-1300-504 | Askı Aparatı / Hanger Parts | Galvaniz / Galvanized | 1 Adet / 1 Pcs | 50 | 2.400 | - | - | - | - |
| 150-9150-1410 | Alüminyum Üst Ray Profili / Aluminium Top Rail Profile | Eloksal / Mat Anodized | mt. | - | - | 2,0 | - | 3,0 | 2 ad/pcs |
| 150-9162-1410 | Alüminyum Alt Klavuz Profili / Aluminium Bottom Slider Profile | Eloksal / Mat Anodized | mt. | - | - | - | - | 3,0 | 20 ad/pcs |

DoorSlide 9700

120 KG SÜRGÜLÜ KAPI SİSTEMİ • SLIDING DOOR SYSTEM



120-9700 1 Takım İçeriği / 1 Kit Includes



Ray Profilleri / Rail Profiles

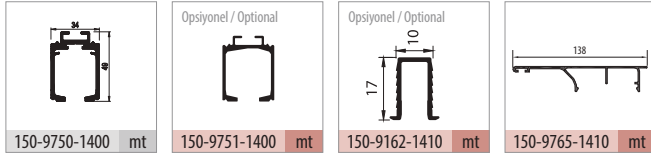

Opsiyonel Aksesuar / Optional Accessories

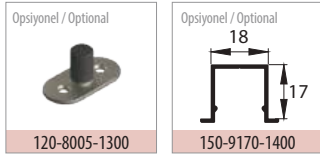

Uygulama / Application



Teknik Detay / Technical Detail

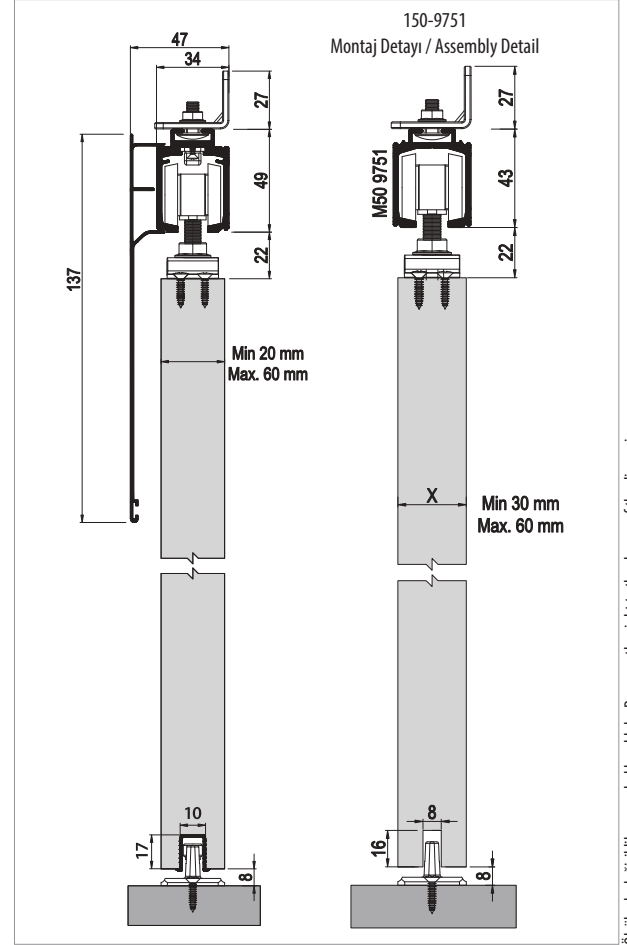

Ölçülerde değişiklik yapma hakkı saklıdır. Reserves the right to the change of the dimensions.

| Kod / Code No | Açıklama / Description | Renk / Colour | Birim / Unit | | | Profil mt. / Profiles mt. | | | Bağ / Bnd. |
|---------------|--|------------------------|----------------|----|-----|---------------------------|---|-----|------------|
| 120-9700-1600 | 120 Kg Sürgü Kapı Sistemi / Sliding Door System | Gri / Grey | 1 Kapı / 1 Kit | 24 | 576 | - | - | - | - |
| 150-9750-1400 | Alüminyum Üst Ray Profili / Aluminium Top Rail Profile | Pres / Uncoated | mt. | - | - | 2,0 | - | 3,0 | 2 ad/pcs |
| 150-9751-1400 | Alüminyum Üst Ray Profili / Aluminium Top Rail Profile | Pres / Uncoated | mt. | - | - | 2,0 | - | 3,0 | 2 ad/pcs |
| 150-9162-1410 | Alüminyum Alt Klavuz Profili / Aluminium Bottom Slider Profile | Eloksal / Mat Anodized | mt. | - | - | - | - | 3,0 | 20 ad/pcs |
| 150-9765-1410 | Alüminyum Alın Kapama / Aluminium Cover Front | Eloksal / Mat Anodized | mt. | - | - | 2,0 | - | 3,0 | 2 ad/pcs |

DoorSlide 9705

120 KG SÜRGÜLÜ KAPI SİSTEMİ • SLIDING DOOR SYSTEM



120-9705 1 Takım İçeriği / 1 Kit Includes



Ray Profilleri / Rail Profiles

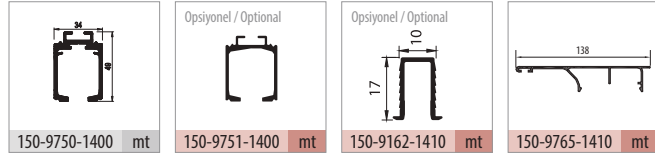

Opsiyonel Aksesuar / Optional Accessories

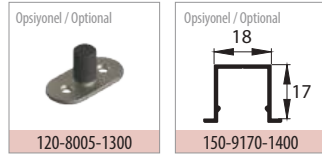

Uygulama / Application



Teknik Detay / Technical Detail

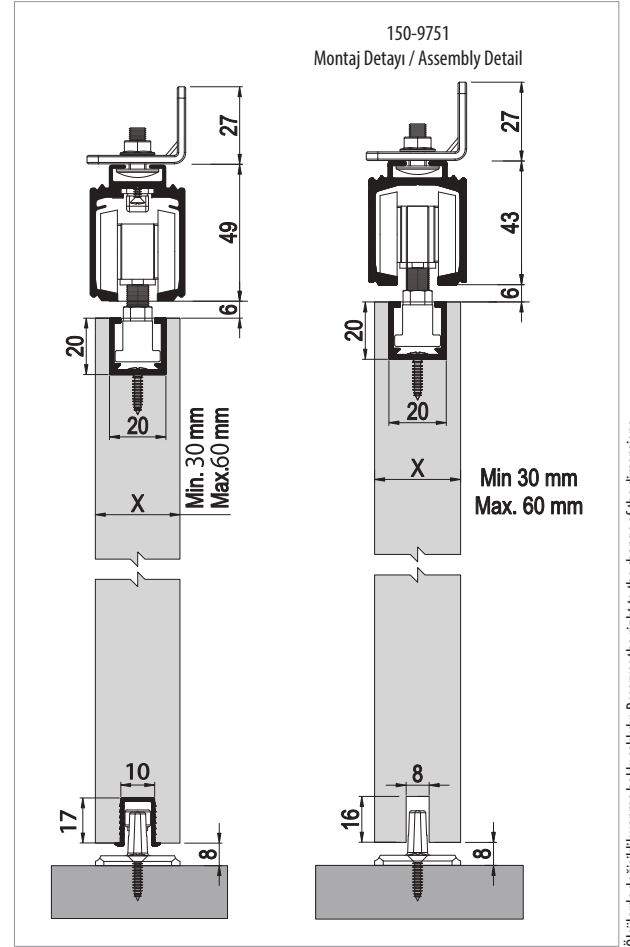

Ölçülerde değişiklik yapma hakkı saklıdır. Reserves the right to the change of the dimensions.

| Kod / Code No | Açıklama / Description | Renk / Colour | Birim / Unit | | | Profil mt. / Profiles mt. | Bağ / Bnd. |
|---------------|--|------------------------|----------------|----|-----|---------------------------|------------|
| 120-9705-1600 | 120 Kg Sürgülü Kapı Sistemi / Sliding Door System | Gri / Grey | 1 Kapı / 1 Kit | 24 | 576 | - - - | - |
| 150-9750-1400 | Alüminyum Üst Ray Profili / Aluminium Top Rail Profile | Pres / Uncoated | mt. | - | - | 2,0 - 3,0 | 2 ad/pcs |
| 150-9751-1400 | Alüminyum Üst Ray Profili / Aluminium Top Rail Profile | Pres / Uncoated | mt. | - | - | 2,0 - 3,0 | 2 ad/pcs |
| 150-9162-1410 | Alüminyum Alt Klavuz Profili / Aluminium Bottom Slider Profile | Eloksal / Mat Anodized | mt. | - | - | - 3,0 | 20 ad/pcs |
| 150-9765-1410 | Alüminyum Alın Kapama / Aluminium Cover Front | Eloksal / Mat Anodized | mt. | - | - | 2,0 - 3,0 | 2 ad/pcs |

DoorSlide 7120

120 KG SÜRGÜLÜ KAPI SİSTEMİ • SLIDING DOOR SYSTEM



120-7120 1 Takım İçeriği / 1 Kit Includes



Ray Profilleri / Rail Profiles

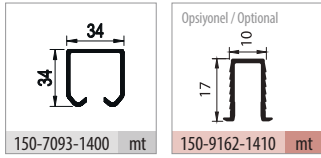

Opsiyonel Aksesuar / Optional Accessories

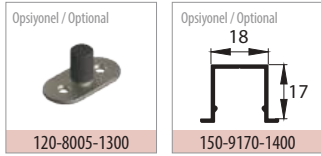

Uygulama / Application



Teknik Detay / Technical Detail

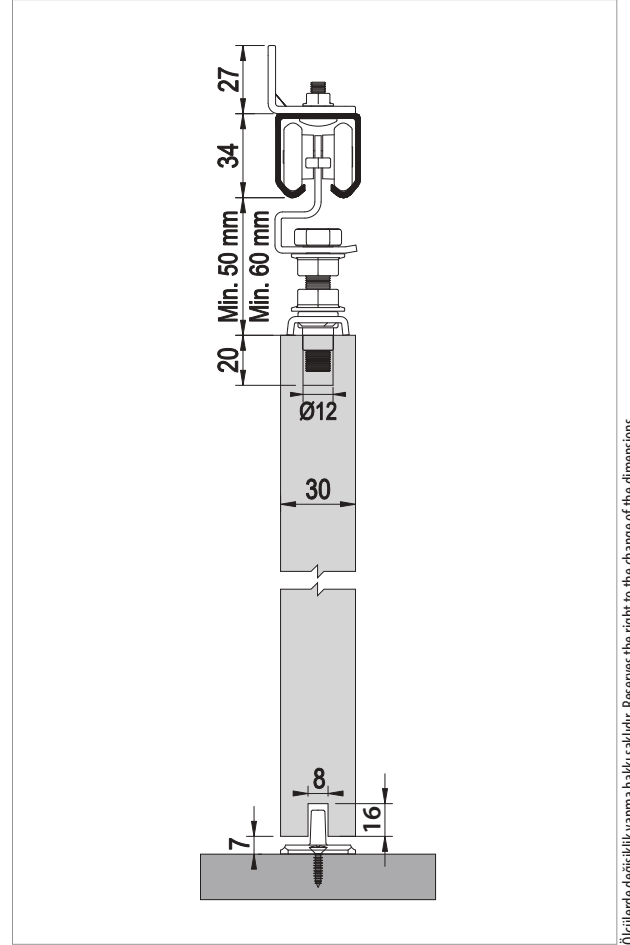

Ölçülerde değişiklik yapma hakkı saklıdır. Reserves the right to the change of the dimensions.

| Kod / Code No | Açıklama / Description | Renk / Colour | Birim / Unit | | | Profil mt. / Profiles mt. | Bağ / Bnd. |
|---------------|--|------------------------|----------------|----|-----|---------------------------|------------|
| 120-7120-1300 | 120 Kg Sürgü Kapı Sistemi / Sliding Door System | Gri / Grey | 1 Kapı / 1 Kit | 24 | 576 | - | - |
| 150-7093-1400 | Alüminyum Üst Ray Profili / Aluminium Top Rail Profile | Pres / Uncoated | mt. | - | - | 2,0 | 3,0 |
| 150-9162-1410 | Alüminyum Alt Klavuz Profili / Aluminium Bottom Slider Profile | Eloksal / Mat Anodized | mt. | - | - | - | 3,0 |



DoorSlide 9015

AYARLI ÇİFT YÖNE YAVAŞLATICILI SÜRME KAPI SİSTEMİ • SLIDING DOOR SYSTEM - TWO WAY SOFT CLOSING

albaturas.com

Group 121

DoorSync® Wood

Ahşap Senkronize Sürme Kapı Serisi

Wooden Funicular Sliding Door Series



Bu serideki tüm ürünleri incelemek için QR kodu okutabilirsiniz.

You can search the QR code to see all the products in these series.

DoorSync Wood

HALATLI SÜRGÜ KAPI SİSTEMİ • FUNICULAR SLIDING DOOR SYSTEM

Group 121

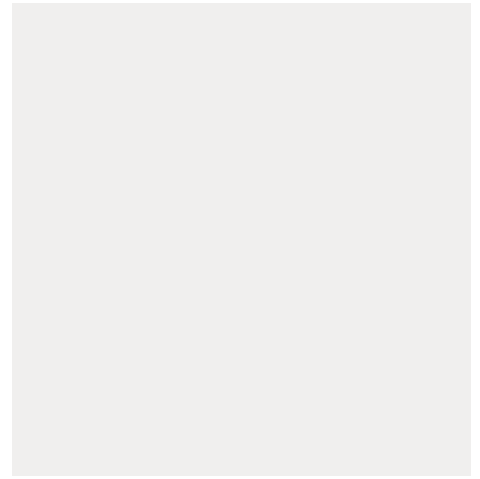
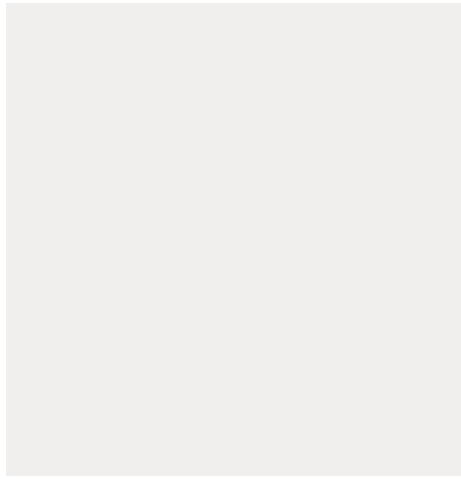
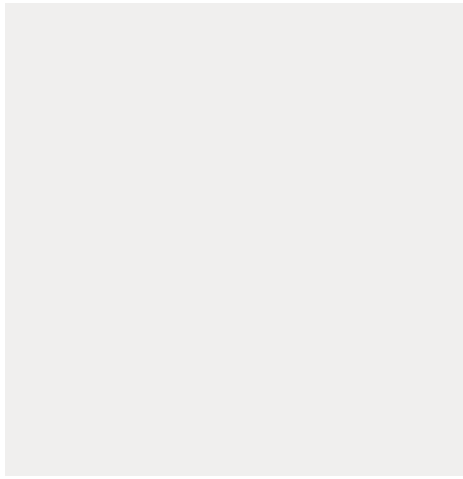
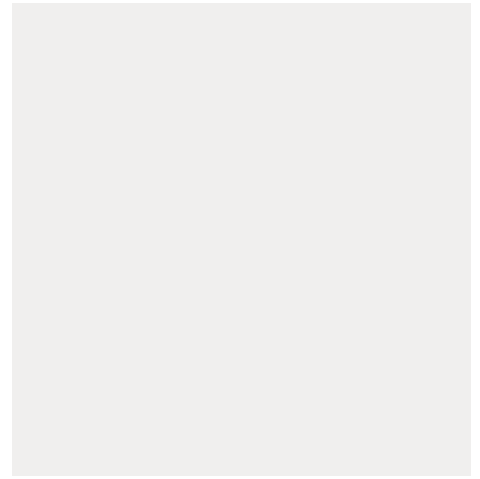
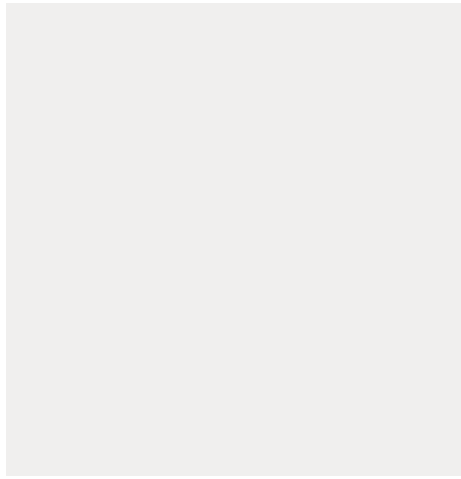
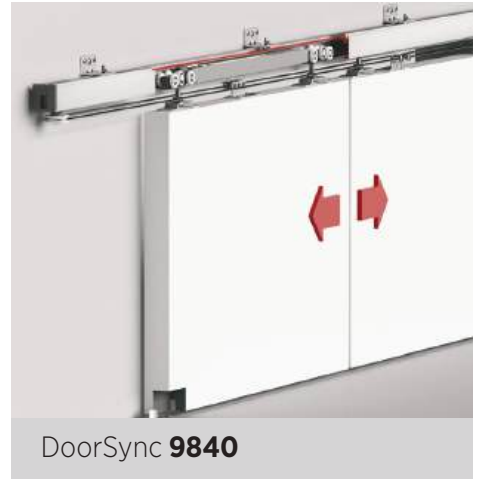

DoorSync 9800

120 KG HALATLI SÜRGÜ KAPI SİSTEMİ • FUNICULAR SLIDING DOOR SYSTEM



121-9800 1 Set İçeriği / 1 Set Includes

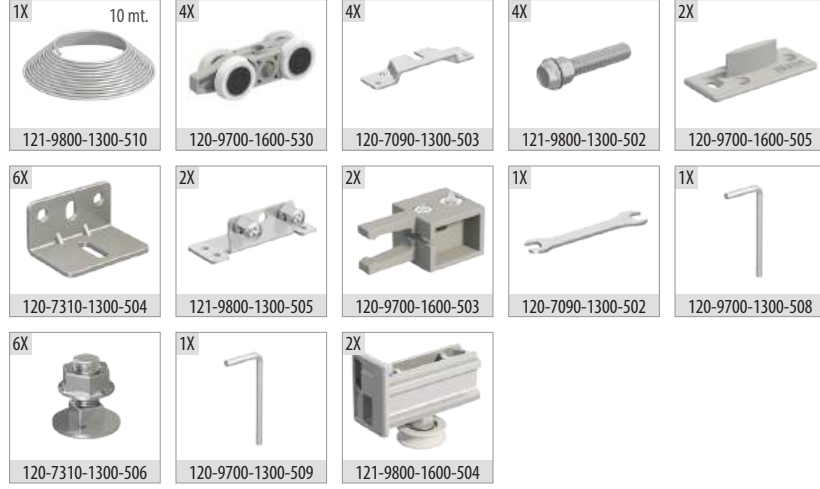

Ray Profilleri / Rail Profiles

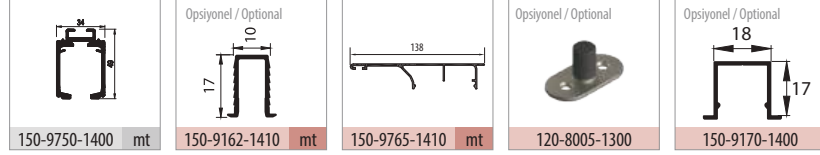

Uygulama / Application



Teknik Detay / Technical Detail

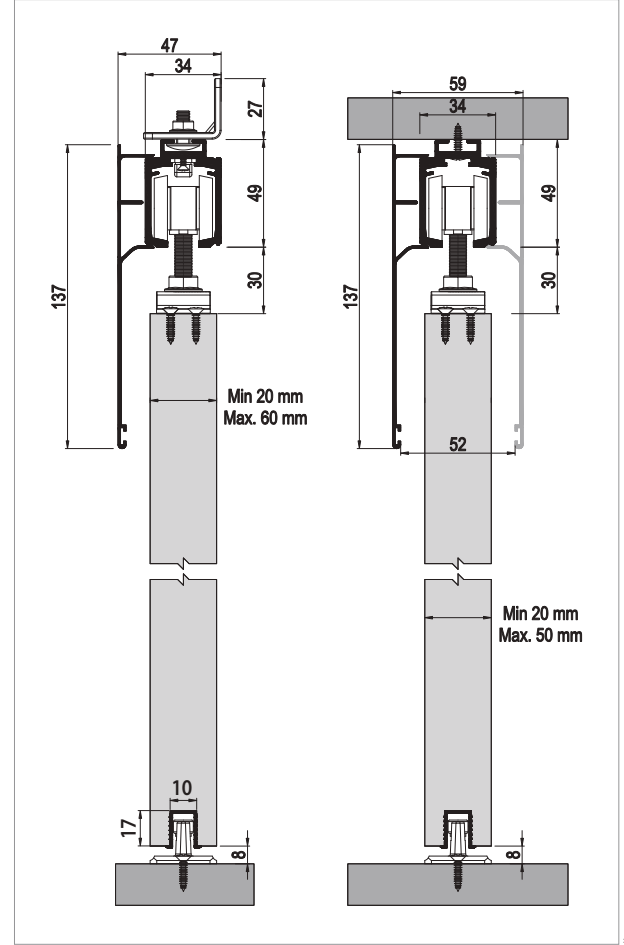

Ölçülerde değişiklik yapma hakkı saklıdır. Reserves the right to the change of the dimensions.

| Kod / Code No | Açıklama / Description | Renk / Colour | Birim / Unit | | | Profil mt. / Profiles mt. | | | Bağ / Bnd. |
|---------------|--|------------------------|----------------|----|-----|---------------------------|-----|-----|------------|
| 121-9800-1600 | 120 Kg Senkronize Sürgü Kapı Sistemi / Funicular Sliding Door System | Gri / Grey | 2 Kapı / 1 Set | 12 | 216 | - | - | - | - |
| 150-9750-1400 | Alüminyum Üst Ray Profili / Aluminium Top Rail Profile | Pres / Uncoated | mt. | - | - | 3,0 | 4,0 | 6,0 | 2 ad/pcs |
| 150-9162-1410 | Alüminyum Alt Klavuz Profili / Aluminium Bottom Slider Profile | Eloksal / Mat Anodized | mt. | - | - | 3,0 | - | - | 20 ad/pcs |
| 150-9765-1410 | Alüminyum Alın Kapama / Aluminium Cover Front | Eloksal / Mat Anodized | mt. | - | - | 3,0 | 4,0 | 6,0 | 2 ad/pcs |

DoorSync 9810

80 KG HALATLI SÜRGÜ KAPI SİSTEMİ • FUNICULAR SLIDING DOOR SYSTEM

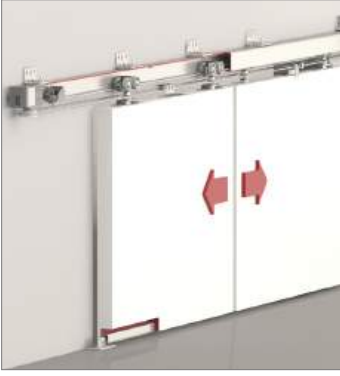

121-9810 1 Set İçeriği / 1 Set Includes



Ray Profilleri / Rail Profiles

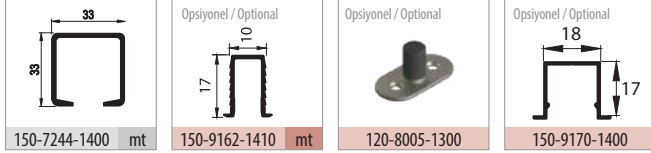

Uygulama / Application



Teknik Detay / Technical Detail

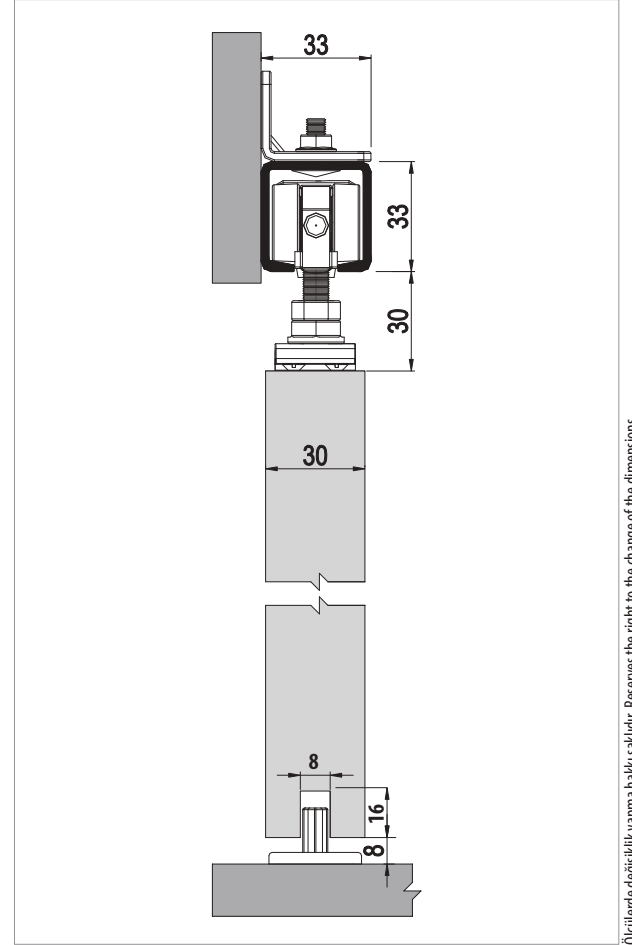

Ölçülerde değişiklik yapma hakkı saklıdır. Reserves the right to the change of the dimensions.

| Kod / Code No | Açıklama / Description | Renk / Colour | Birim / Unit | | | Profil mt. / Profiles mt. | | | Bağ / Bnd. |
|---------------|---|------------------------|----------------|----|-----|---------------------------|-----|-----|------------|
| 121-9810-1600 | 80 Kg Senkronize Sürgü Kapi Sistemi / Funicular Sliding Door System | Gri / Grey | 2 Kapı / 1 Set | 12 | 216 | - | - | - | - |
| 150-7244-1400 | Alüminyum Üst Ray Profili / Aluminium Top Rail Profile | Pres / Uncoated | mt. | - | - | 3,0 | 4,0 | 6,0 | 6 ad/pcs |
| 150-9162-1410 | Alüminyum Alt Klavuz Profili / Aluminium Bottom Slider Profile | Eloksal / Mat Anodized | mt. | - | - | - | - | 3,0 | 20 ad/pcs |

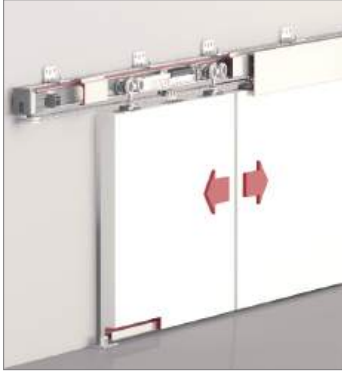

Bilgi / Information

- Minimum kapı genişliği 500 mm olmalıdır.
- Min. Door width 500 mm

Yavaşlatıcı Alternatifi / Soft Closer Alternative

- Sistem üzerinde tek yöne yavaşlatıcı mevcuttur.
- The system has one way soft closing.



121-9801 1 Set İçeriği / 1 Set Includes



Ray Profilleri / Rail Profiles

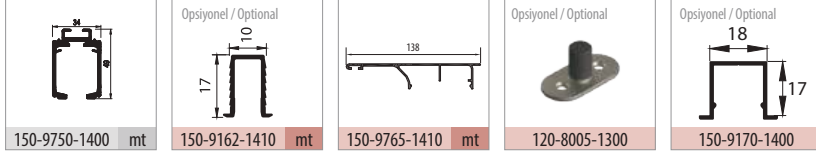

Uygulama / Application



Teknik Detay / Technical Detail

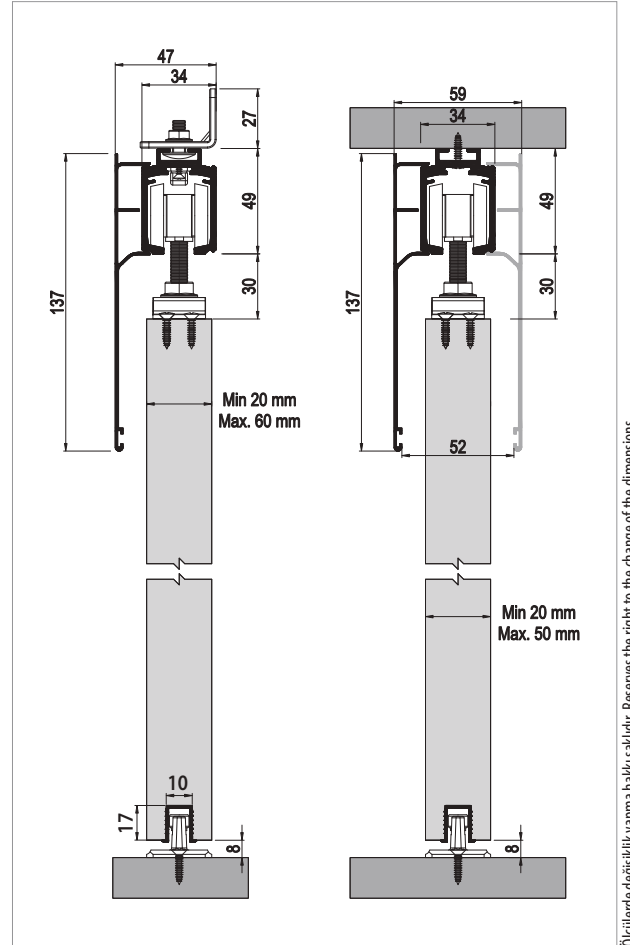

Ölçülerde değişiklik yapma hakkı saklıdır. Reserves the right to the change of the dimensions.

| Kod / Code No | Açıklama / Description | Renk / Colour | Birim / Unit | | | Profil mt. / Profiles mt. | Bağ / Bnd. |
|---------------|---|------------------------|----------------|----|-----|---------------------------|------------|
| 121-9801-1600 | 120 Kg Yavaşlatıcılı Halatlı Sürgü Kapı Sistemi / Funicular Sliding Door Has Soft Closing | Gri / Grey | 2 Kapı / 1 Set | 12 | 216 | - | - |
| 150-9750-1400 | Alüminyum Üst Ray Profili / Aluminium Top Rail Profile | Pres / Uncoated | mt. | - | - | 3,0 | 4,0 |
| 150-9162-1410 | Alüminyum Alt Klavuz Profili / Aluminium Bottom Slider Profile | Eloksal / Mat Anodized | mt. | - | - | 3,0 | - |
| 150-9765-1410 | Alüminyum Alın Kapama / Aluminium Cover Front | Eloksal / Mat Anodized | mt. | - | - | 3,0 | 4,0 |

DoorSync 9820

120 KG ÇİFT YÖNE YAVAŞLATICILI HALATLI SÜRGÜ KAPI SİSTEMİ • FUNICULAR SLIDING DOOR SYSTEM - HAS SOFT CLOSING



Bilgi / Information

- Minimum kapı genişliği 830 mm olmalıdır.
- Min. Door width 830 mm

Yavaşlatıcı Alternatifi / Soft Closer Alternative

- Sistem üzerinde çift yöne yavaşlatıcı mevcuttur.
- The system has two way soft closing.



121-9820 1 Set İçeriği / 1 Set Includes



Ray Profilleri / Rail Profiles

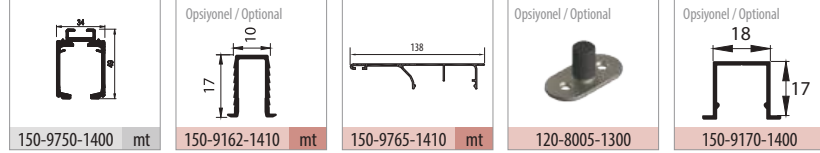

Uygulama / Application



Teknik Detay / Technical Detail

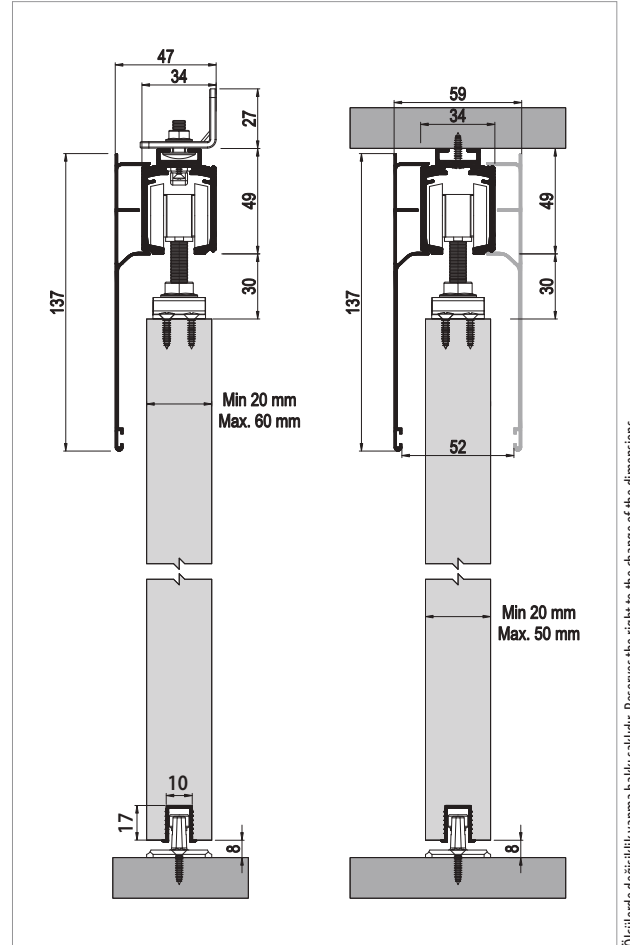

Ölçülerde değişiklik yapma hakkı saklıdır. Reserves the right to the change of the dimensions.

| Kod / Code No | Açıklama / Description | Renk / Colour | Birim / Unit | | | Profil mt. / Profiles mt. | | | Bağ / Bnd. |
|---------------|---|------------------------|----------------|----|-----|---------------------------|-----|-----|------------|
| 121-9820-1600 | 120 Kg Yavaşlatıcılı Halatlı Sürgü Kapı Sistemi / Funicular Sliding Door Has Soft Closing | Gri / Grey | 2 Kapı / 1 Set | 12 | 216 | - | - | - | - |
| 150-9750-1400 | Alüminyum Üst Ray Profili / Aluminium Top Rail Profile | Pres / Uncoated | mt. | - | - | 3,0 | 4,0 | 6,0 | 2 ad/pcs |
| 150-9162-1410 | Alüminyum Alt Klavuz Profili / Aluminium Bottom Slider Profile | Eloksal / Mat Anodized | mt. | - | - | 3,0 | - | - | 20 ad/pcs |
| 150-9765-1410 | Alüminyum Alın Kapama / Aluminium Cover Front | Eloksal / Mat Anodized | mt. | - | - | 3,0 | 4,0 | 6,0 | 2 ad/pcs |

DoorSync 9830

60 KG ÇİFT YÖNE YAVAŞLATICILI HALATLI SÜRGÜ KAPI SİSTEMİ • FUNICULAR SLIDING DOOR SYSTEM - HAS SOFT CLOSING

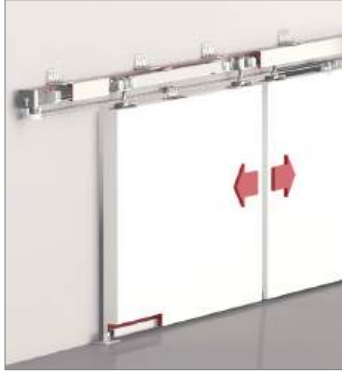

Bilgi / Information

- Minimum kapı genişliği 650 mm olmalıdır.
- Min. Door width 650 mm

Yavaşlatıcı Alternatifi / Soft Closer Alternative

- Sistem üzerinde çift yöne yavaşlatıcı mevcuttur.
- The system has two way soft closing.



121-9830 1 Set İçeriği / 1 Set Includes



Ray Profilleri / Rail Profiles

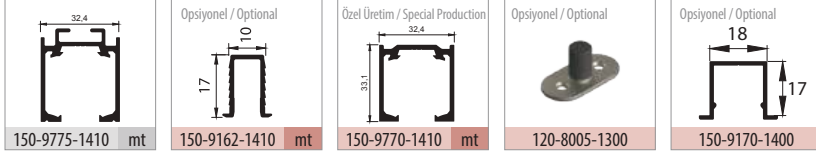

Uygulama / Application



Teknik Detay / Technical Detail

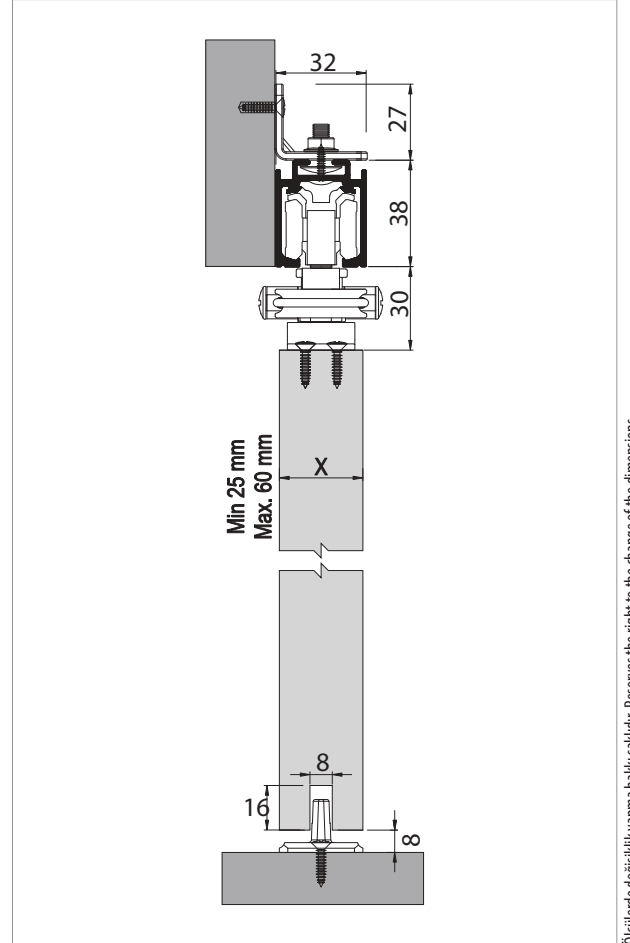

Ölçülerde değişiklik yapma hakkı saklıdır. Reserves the right to the change of the dimensions.

| Kod / Code No | Açıklama / Description | Renk / Colour | Birim / Unit | | | Profil mt. / Profiles mt. | | | Bağ / Bnd. |
|---------------|--|------------------------|----------------|---|-----|---------------------------|-----|-----|------------|
| 121-9830-1410 | 60 Kg Yavaşlatıcılı Halatlı Sürgü Kapı Sistemi / Funicular Sliding Door Has Soft Closing | Gri / Grey | 2 Kapı / 1 Set | 4 | 160 | - | - | - | - |
| 150-9775-1410 | Alüminyum Üst Ray Profili / Aluminium Top Rail Profile | Eloksal / Mat Anodized | mt. | - | - | 3,0 | 4,0 | 6,0 | 6 ad/pcs |
| 150-9162-1410 | Alüminyum Alt Klavuz Profili / Aluminium Bottom Slider Profile | Eloksal / Mat Anodized | mt. | - | - | 3,0 | 4,0 | - | 20 ad/pcs |

DoorSync 9840

40 KG ÇİFT YÖNE YAVAŞLATICILI HALATLI SÜRGÜ KAPI SİSTEMİ • FUNICULAR SLIDING DOOR SYSTEM - HAS SOFT CLOSING

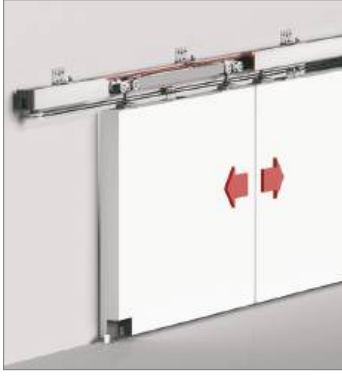

Bilgi / Information

- Minimum kapı genişliği 450 mm olmalıdır.
- Min. Door width 450 mm

Yavaşlatıcı Alternatifi / Soft Closer Alternative

- Sistem üzerinde çift yöne yavaşlatıcı mevcuttur.
- The system has two way soft closing.



121-9840 1 Set İçeriği / 1 Set Includes



Ray Profilleri / Rail Profiles

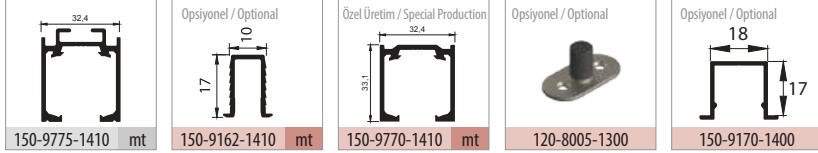

Uygulama / Application



Teknik Detay / Technical Detail

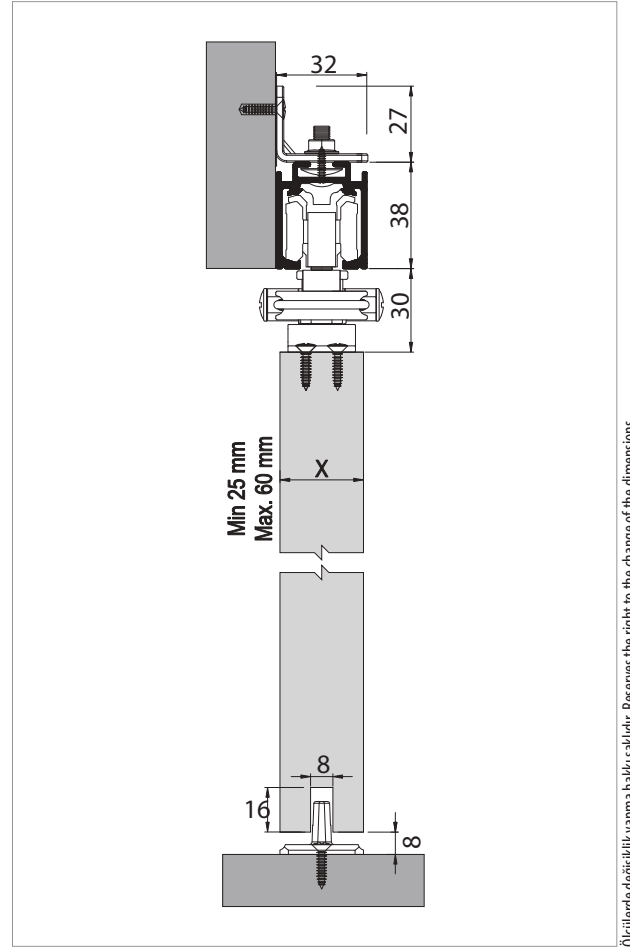

Ölçülerde değişiklik yapma hakkı saklıdır. Reserves the right to the change of the dimensions.

| Kod / Code No | Açıklama / Description | Renk / Colour | Birim / Unit | | | Profil mt. / Profiles mt. | Bağ / Bnd. |
|---------------|--|------------------------|----------------|----|-----|---------------------------|------------|
| 121-9840-1410 | 40 Kg Yavaşlatıcılı Halatlı Sürgü Kapı Sistemi / Funicular Sliding Door Has Soft Closing | Gri / Grey | 2 Kapı / 1 Set | 12 | 216 | - | - |
| 150-9775-1410 | Alüminyum Üst Ray Profili / Aluminium Top Rail Profile | Eloksal / Mat Anodized | mt. | - | - | 3,0 | 6,0 |
| 150-9162-1410 | Alüminyum Alt Klavuz Profili / Aluminium Bottom Slider Profile | Eloksal / Mat Anodized | mt. | - | - | 3,0 | 20 ad/pcs |

DoorSync 9850

60 KG ÇİFT YÖNE YAVAŞLATICILI HALATLI SÜRGÜ KAPI SİSTEMİ • FUNICULAR SLIDING DOOR SYSTEM - HAS SOFT CLOSING

Özel Üretim
Special Production

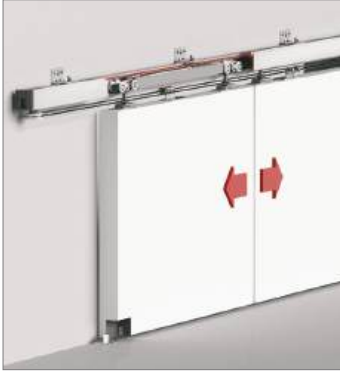

Bilgi / Information

- Minimum kapı genişliği 610 mm olmalıdır.
- Min. Door width 610 mm

Yavaşlatıcı Alternatifi / Soft Closer Alternative

- Sistem üzerinde çift yöne yavaşlatıcı mevcuttur.
- The system has two way soft closing.



121-9850 1 Set İçeriği / 1 Set Includes



Ray Profilleri / Rail Profiles

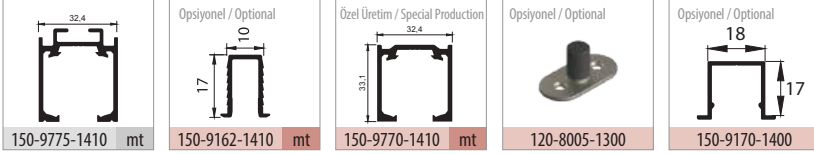

Uygulama / Application



Teknik Detay / Technical Detail

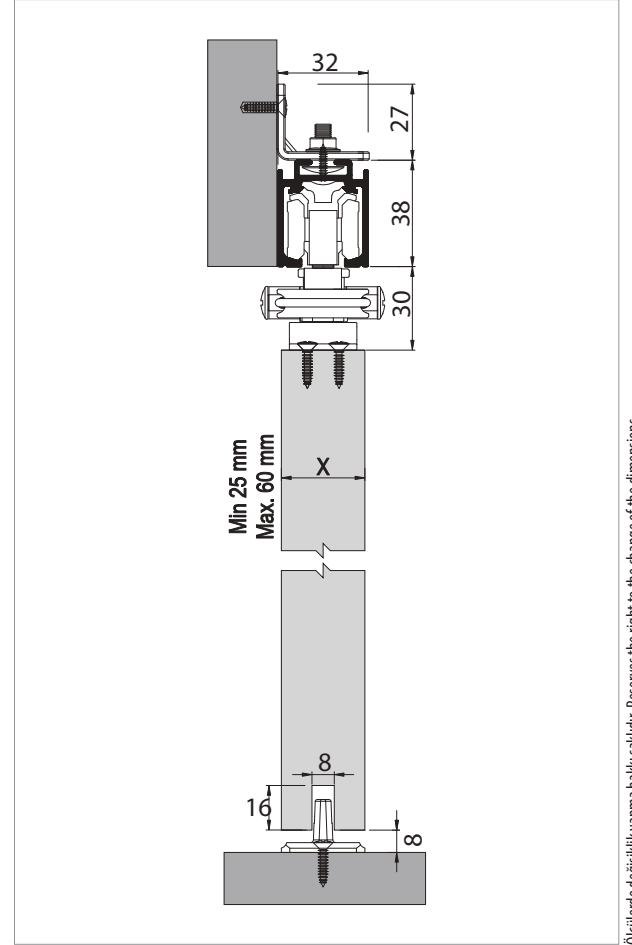

Ölçülerde değişiklik yapma hakkı saklıdır. Reserves the right to the change of the dimensions.

| Kod / Code No | Açıklama / Description | Renk / Colour | Birim / Unit | | | Profil mt. / Profiles mt. | Bağ / Bnd. |
|---------------|--|------------------------|----------------|---|-----|---------------------------|------------|
| 121-9850-1410 | 40 Kg Yavaşlatıcılı Halatlı Sürgü Kapı Sistemi / Funicular Sliding Door Has Soft Closing | Gri / Grey | 2 Kapı / 1 Set | 4 | 160 | - | - |
| 150-9775-1410 | Alüminyum Üst Ray Profili / Aluminium Top Rail Profile | Eloksal / Mat Anodized | mt. | - | - | 3,0 | 6,0 |
| 150-9162-1410 | Alüminyum Alt Klavuz Profili / Aluminium Bottom Slider Profile | Eloksal / Mat Anodized | mt. | - | - | 3,0 | 20 ad/pcs |



DoorSync 9820

ÇİFT YÖNE YAVAŞLATICILI HALATLI SÜRGÜ KAPI SİSTEMİ • FUNICULAR SLIDING DOOR SYSTEM - HAS SOFT CLOSING

albaturas.com

MasterFold®

MidFold®

Ahşap Katlanır Sürme Kapı Serisi

Wooden Foldable Sliding Door Series



Bu serideki tüm ürünleri incelemek için QR kodu okutabilirsiniz.

You can search the QR code to see all the products in these series.

MasterFold & MidFold

AHŞAP KATLANIR SÜRME KAPI SERİSİ • WOODEN FOLDABLE SLIDING DOOR SERIES

Group **122**

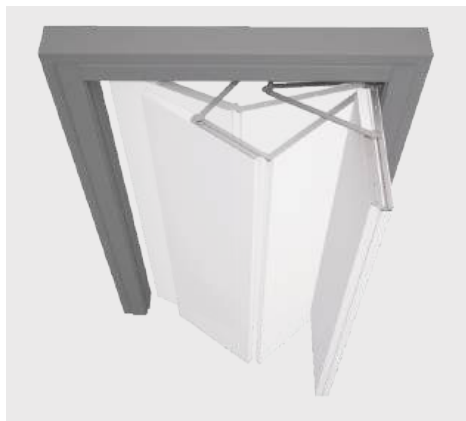

Domino **90**

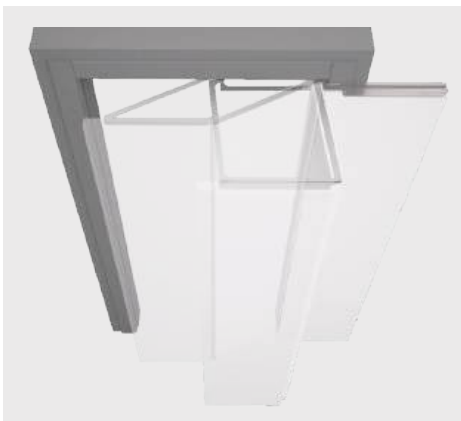

Domino **180**



MasterFold **42**



MasterFold **44**



MasterFold **60**



MidFold **60**



MasterFold **160**



MidFold **160**



122-1050-1800



122-1052-1820

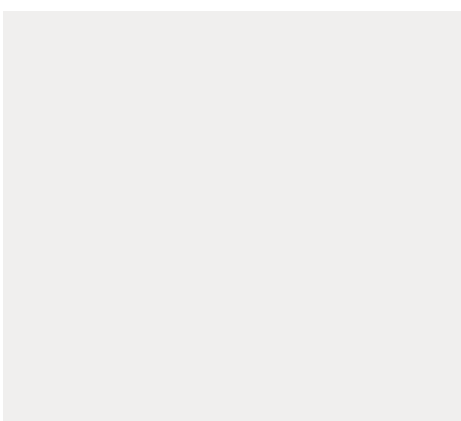

122-1050-1800

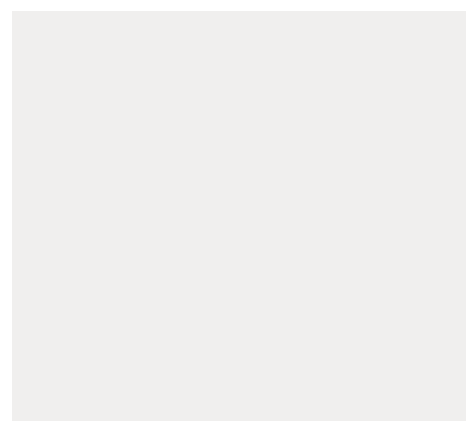

122-1050-1800

Domino 90

90 DERECE AÇILIR KATLANIR KAPI DONANIMI • 90 DEGREE BI-FOLDING DOOR HARDWARE

Yeni Ürün
New Product

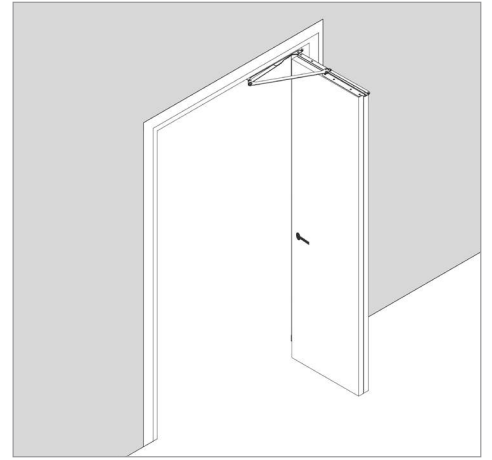
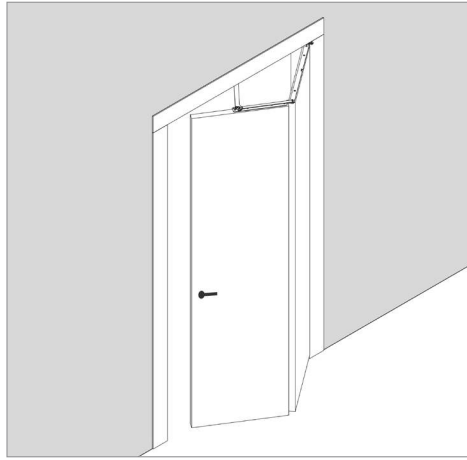
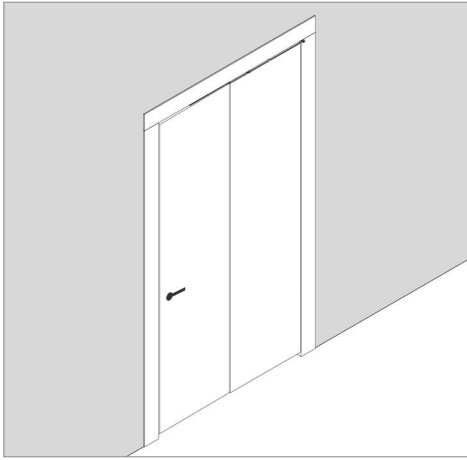

| Kod / Code No | Açıklama / Description | Boy / Size | Birim / Unit |
|--------------------|-----------------------------------|------------|---------------|
| 122-0090-1820-0600 | Domino 90 - Sağ Kapı / Right Door | 600 mm | 1 Tk. / 1 Set |
| 122-0090-1820-0700 | Domino 90 - Sağ Kapı / Right Door | 700 mm | 1 Tk. / 1 Set |
| 122-0090-1820-0800 | Domino 90 - Sağ Kapı / Right Door | 800 mm | 1 Tk. / 1 Set |
| 122-0090-1820-0900 | Domino 90 - Sağ Kapı / Right Door | 900 mm | 1 Tk. / 1 Set |
| 122-0090-1820-1000 | Domino 90 - Sağ Kapı / Right Door | 1.000 mm | 1 Tk. / 1 Set |
| 122-0095-1820-0600 | Domino 90 - Sol Kapı / Left Door | 600 mm | 1 Tk. / 1 Set |
| 122-0095-1820-0700 | Domino 90 - Sol Kapı / Left Door | 700 mm | 1 Tk. / 1 Set |
| 122-0095-1820-0800 | Domino 90 - Sol Kapı / Left Door | 800 mm | 1 Tk. / 1 Set |
| 122-0095-1820-0900 | Domino 90 - Sol Kapı / Left Door | 900 mm | 1 Tk. / 1 Set |
| 122-0095-1820-1000 | Domino 90 - Sol Kapı / Left Door | 1.000 mm | 1 Tk. / 1 Set |

Bilgi / Information

- 90 derece katlanıp park edilebilir kapı makas sistemidir.
- Dar alan bölgelerde kapının açıldığı esnada yerden tasarruf edilmesini sağlar.
- Ahşap kapılar için tasarlanmıştır.
- 36-44 mm ahşap kapılarda kullanıma uygundur.
- Hızlı montaj kiti 40 mm kapılar için kullanılabilir.
- Sistemin toplam taşıma kapasitesi 50 kg dir.
- Kolay ve ahşap kapı üzerinde herhangi bir freze/cnc işlem gerektirmeden montaj edilebilmesi için montaj yatak kiti kullanılarak da uygulanabilir özelliğe sahiptir.
- Montaj yatak kiti istenilen renkte boyanarak kapı ile bir bütünlük sağlanabilir.
- Ahşap üzerine işlem yapmadan montaj edilebilir.
- Mekanizma gövdesi paslanmaz malzemeden imal edilmiştir.
- Islak mekanlarda kullanılabilir.
- Farklı kanat açıklıkları için 5 tip ölçüde imal edilmiştir.
- Kapının park ettiği alanın görüleceği içten bakış yönüne göre sağ ve sol mekanizma olarak 2 tip üretimi mevcuttur.
- Estetik görünüm ve sağlıklı çalışma sistemine sahiptir.
- İç mekan kapılarda kullanıma uygundur.
- Kapı üzerine istenilen açma kolu ve/veya tutamak tek yönlü montaj edilebilmektedir.

- It's door scissor system that can be fold and parked 90 degrees.
- It's saves space when opening the door in narrow areas.
- Designed for wooden doors.
- It's available for use on 36-44 mm wooden doors.
- The quick assembly kit can be used for 40 mm
- Total carrying capacity of the system is 50 kg.
- Can also be apply by using the mounting bed kit for easy fixing on the wooden door without any milling cutter /cnc operation.
- The assembly bed kit can be paint in the required color and an integrity with the door can be achieved.
- Can be mounted on wood without processing.
- Mechanism body is made of stainless material.
- Can be used in wet places.
- For the gaps of wing , it's produced in 5 different types of sizes
- There are 2 types of production; as right and left mechanism according to the inside view direction from which the area where the door is parked will be seen.
- It has aesthetic appearance and in well working system
- Available for use on interior doors.
- The required door handle and/or handle can be fixing on the door in one direction.

Domino 180

180 DERECE AÇILIR KATLANIR KAPI DONANIMI • 180 DEGREE BI-FOLDING DOOR HARDWARE

Yeni Ürün
New Product

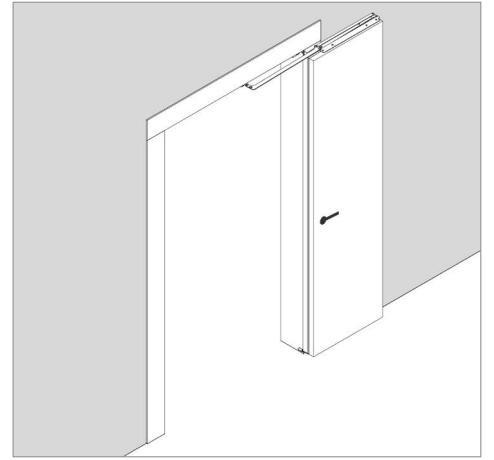
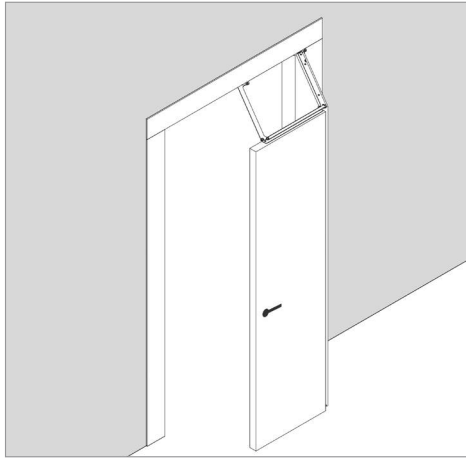
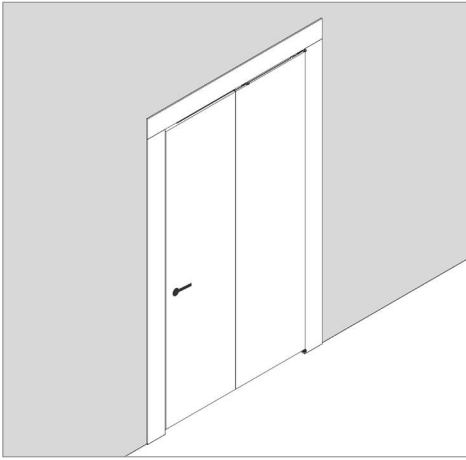

| Kod / Code No | Açıklama / Description | Boy / Size | Birim / Unit |
|--------------------|------------------------------------|------------|---------------|
| 122-0180-1820-0600 | Domino 180 - Sağ Kapı / Right Door | 600 mm | 1 Tk. / 1 Set |
| 122-0180-1820-0700 | Domino 180 - Sağ Kapı / Right Door | 700 mm | 1 Tk. / 1 Set |
| 122-0180-1820-0800 | Domino 180 - Sağ Kapı / Right Door | 800 mm | 1 Tk. / 1 Set |
| 122-0180-1820-0900 | Domino 180 - Sağ Kapı / Right Door | 900 mm | 1 Tk. / 1 Set |
| 122-0180-1820-1000 | Domino 180 - Sağ Kapı / Right Door | 1.000 mm | 1 Tk. / 1 Set |
| 122-0185-1820-0600 | Domino 180 - Sol Kapı / Left Door | 600 mm | 1 Tk. / 1 Set |
| 122-0185-1820-0700 | Domino 180 - Sol Kapı / Left Door | 700 mm | 1 Tk. / 1 Set |
| 122-0185-1820-0800 | Domino 180 - Sol Kapı / Left Door | 800 mm | 1 Tk. / 1 Set |
| 122-0185-1820-0900 | Domino 180 - Sol Kapı / Left Door | 900 mm | 1 Tk. / 1 Set |
| 122-0185-1820-1000 | Domino 180 - Sol Kapı / Left Door | 1.000 mm | 1 Tk. / 1 Set |

Bilgi / Information

- 180 derece katlanıp park edebilen kapı makas sistemidir.
- Dar alan bölgelerde kapının açıldığı esnada yerden tasarruf edilmesini sağlar.
- Kapı park yönünde, kapı net açıklığının yarısı kadar bir mesafede açılarak net geçiş açıklığının tamamını kullanmanızı sağlar.
- Ahşap kapılar için tasarlanmıştır.
- 36-44 mm ahşap kapılarda kullanıma uygundur .
- Hızlı montaj kiti 40 mm kapılar için kullanılabilir.
- Sistemin toplam taşıma kapasitesi 50 kg dir.
- Gerekli durumlarda gizli menteşe kullanımı ile 3 kanat tek yönde kullanıma uygundur .
- Kolay ve ahşap kapı üzerinde herhangi bir freze/cnc işlem gerektirmeden montaj edilebilmesi için montaj yatak kiti kullanılarak da uygulanabilir özelliğe sahiptir.
- Montaj yatak kiti istenilen renkte boyanarak kapı ile bir bütünlük sağlanabilir .
- Ahşap üzerine işlem yapmadan montaj edilebilir.
- Mekanizma gövdesi paslanmaz malzemeden imal edilmiştir.
- Islak mekanlarda kullanılabilir.
- Farklı kanat açıklıkları için 5 tip ölçüde imal edilmiştir.
- Kapının park ettiği alanın görüleceği içten bakış yönüne göre sağ ve sol mekanizma olarak 2 tip üretimi mevcuttur.
- Estetik görünüm ve sağlıklı çalışma sistemine sahiptir.
- İç mekan kapılarda kullanıma uygundur.
- Kapı üzerine istenilen açma kolu ve/veya tutamak tek yönlü montaj edilebilmektedir.

- It's Door Scissor System that can be fold and parked 180 degrees.
- It's saves space when opening the door in narrow areas.
- The doors in parking direction, at a distance of half the door clear opening, allowing to use the entire clear passage opening.
- Designed for wooden doors.
- It's available for use on 36-44 mm wooden doors.
- The quick assembly kit can be used for 40 mm doors.
- Total carrying capacity of the system is 50 kg.
- 3 doors are suitable for use in one direction with the use of hidden hinges when its necessary .
- Can also be apply by using the mounting bed kit for easy fixing on the wooden door without any milling cutter /cnc operation.
- The assembly bed kit can be paint in the required color and an integrity with the door can be achieved.
- Can be mounted on wood without processing.
- Mechanism body is made of stainless material.
- Can be used in wet places.
- For the gaps of wing, it's produced in 5 different types of sizes.
- There are 2 types of production; as right and left mechanism according to the inside view direction from which the area where the door is parked will be seen.
- It has aesthetic appearance and in well working system
- Available for use on interior doors.
- The required door handle and/or handle can be fixing on the door in one direction.

MasterFold 42

40 KG KATLANIR SÜRME KAPI SİSTEMİ • FOLDABLE DOOR MECHANISM - FOLDING DOOR

Yeni Ürün
New Product



Bilgi / Information

- 2 Kapılı mekanizma içermektedir.
- Includes 2 door mechanism.



122-9042 1 Set İçeriği / 1 Set Includes



Ray Profilleri / Rail Profiles

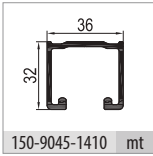

Uygulama / Application



Teknik Detay / Technical Detail

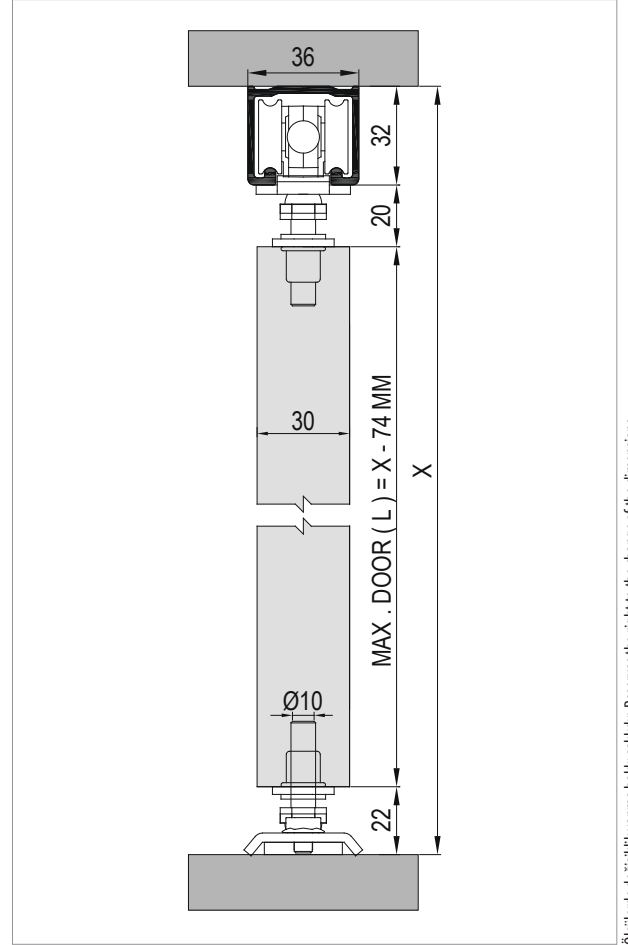

Ölçülerde değişiklik yapma hakkı saklıdır. Reserves the right to the change of the dimensions.

| Kod / Code No | Açıklama / Description | Renk / Colour | Birim / Unit | | | Profil mt. / Profiles mt. | Bağ / Bnd. |
|---------------|--|------------------------|----------------|----|-----|---------------------------|------------|
| 122-9042-1300 | 40 Kg Katlanır Sürme Kapı Sistemi / Foldable Door Mechanism - Folding Door | Gri / Grey | 2 Kapı / 1 Set | 12 | 360 | - | - |
| 150-9045-1410 | Alüminyum Üst Ray Profili / Aluminium Top Rail Profile | Eloksal / Mat Anodized | mt. | - | - | 3,0 | 6,0 |

MasterFold 44

40 KG KATLANIR SÜRME KAPI SİSTEMİ • FOLDABLE DOOR MECHANISM - FOLDING DOOR

Yeni Ürün
New Product



Bilgi / Information

- 4 Kapılı mekanizma içermektedir.
- Includes 4 door mechanism.



122-9044 1 Set İçeriği / 1 Set Includes



Ray Profilleri / Rail Profiles

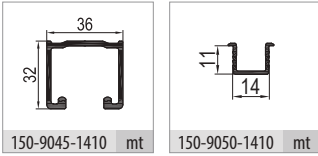

Uygulama / Application



Teknik Detay / Technical Detail

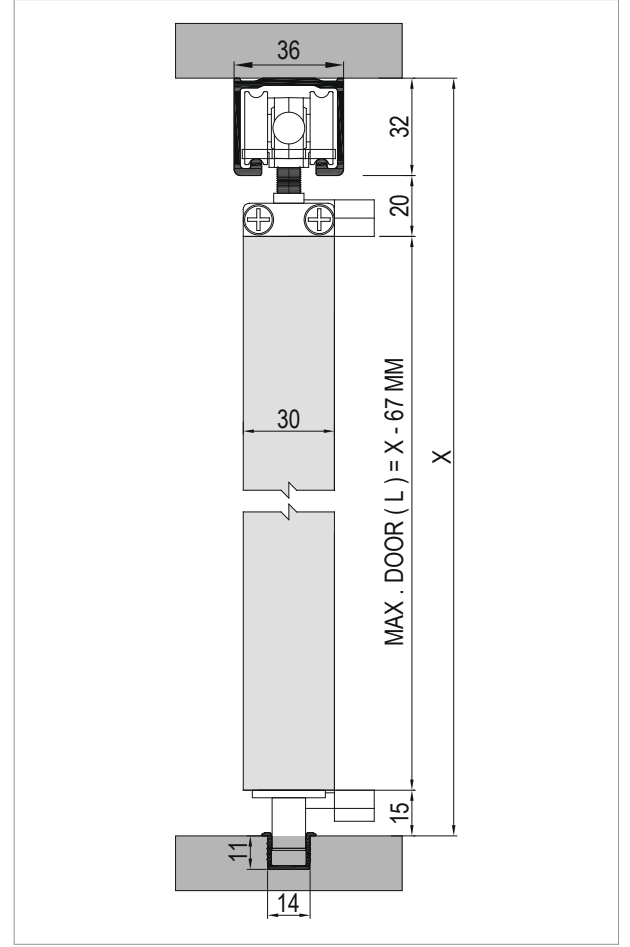

Ölçülerde değişiklik yapma hakkı saklıdır. Reserves the right to the change of the dimensions.

| Kod / Code No | Açıklama / Description | Renk / Colour | Birim / Unit | | | Profil mt. / Profiles mt. | Bağ / Bnd. |
|---------------|--|------------------------|----------------|---|-----|---------------------------|------------|
| 122-9044-1300 | 40 Kg Katlanır Sürme Kapı Sistemi / Foldable Door Mechanism - Folding Door | Gri / Grey | 4 Kapı / 1 Set | 6 | 180 | - | - |
| 150-9045-1410 | Alüminyum Üst Ray Profili / Aluminium Top Rail Profile | Eloksal / Mat Anodized | mt. | - | - | 3,0 | 6,0 |
| 150-9050-1410 | Alüminyum Alt Klavuz / Aluminium Bottom Slider | Eloksal / Mat Anodized | mt. | - | - | 3,0 | 6,0 |

MasterFold 60

60 KG KATLANIR SÜRME KAPI SİSTEMİ • FOLDABLE DOOR MECHANISM - FOLDING DOOR

Yeni Ürün
New Product



Bilgi / Information

- Minimum kapı panel kalınlığı 36 mm. olmalıdır.
- Door panel's thickness should be minimum 36 mm.



122-9060 1 Takım İçeriği / 1 Kit Includes

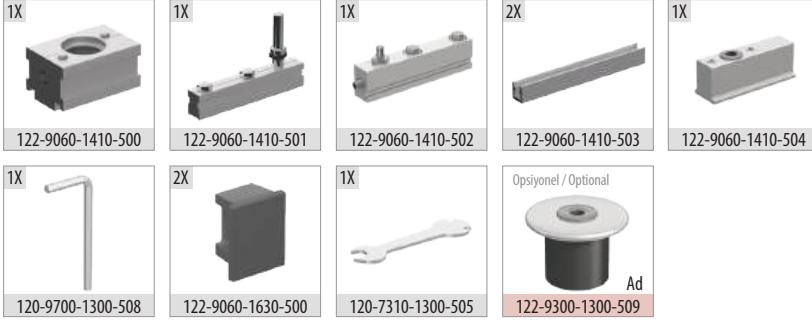

9061 1 Takım İçeriği / 1 Kit Includes

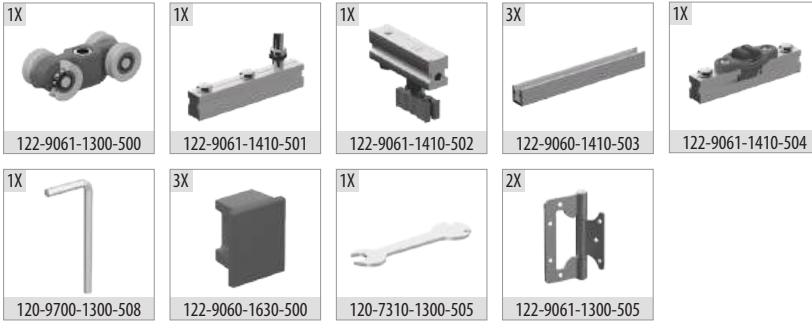

Ray Profilleri / Rail Profiles

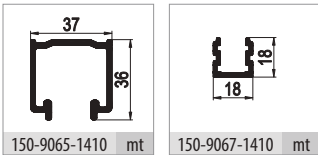

Uygulama / Application



Teknik Detay / Technical Detail

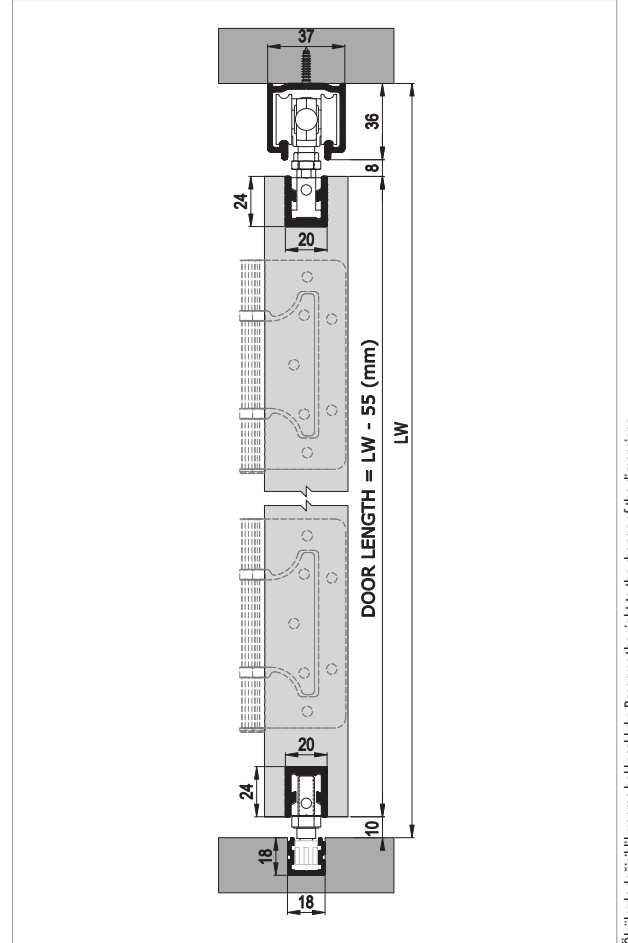

| Kod / Code No | Açıklama / Description | Renk / Colour | Birim / Unit | | | Profil mt. / Profiles mt. | Bağ / Bnd. |
|-------------------|--|------------------------|----------------|-----|-------|---------------------------|---------------|
| 122-9060-1410 | Masterfold 60 - Sabit Kanat / Foldable Heavy Door System | Gri / Grey | 1 Kapı / 1 Kit | 16 | 512 | - | - |
| 122-9061-1410 | Masterfold 60 - Sürme Katlanır Kapı Sistemi / Sliding Foldable Heavy Door System | Gri / Grey | 1 Kapı / 1 Kit | 16 | 512 | - | - |
| 122-9061-1300-505 | Çelik Menteşe / Steel Hinge | Galvaniz / Galvanized | 1 Adet / 1 Pcs | 50 | 2.400 | - | - |
| 122-9300-1300-509 | Zemin Pivot Burcu Paslanmaz / Ground Pivot Stainless | Galvaniz / Galvanized | 1 Adet / 1 Pcs | 100 | 9.600 | - | - |
| 150-9065-1410 | Alüminyum Üst Ray Profili / Aluminium Top Rail Profile | Eloksal / Mat Anodized | mt. | - | - | - | 6,0 6 ad/pcs |
| 150-9067-1410 | Alüminyum Alt Klavuz / Aluminium Bottom Slider | Eloksal / Mat Anodized | mt. | - | - | - | 6,0 10 ad/pcs |

MidFold 60

60 KG KATLANIR SÜRME KAPI SİSTEMİ • FOLDABLE DOOR MECHANISM - FOLDING DOOR

Yeni Ürün
New Product



Bilgi / Information

- Minimum kapı panel kalınlığı 36 mm. olmalıdır.
- Door panel's thickness should be minimum 36 mm.



122-9060 1 Takım İçeriği / 1 Kit Includes

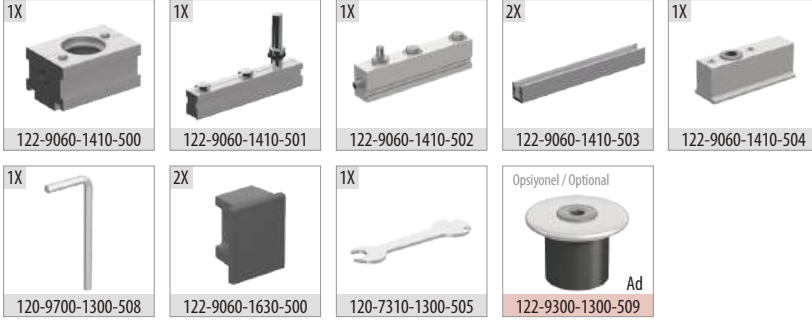

9062 1 Takım İçeriği / 1 Kit Includes

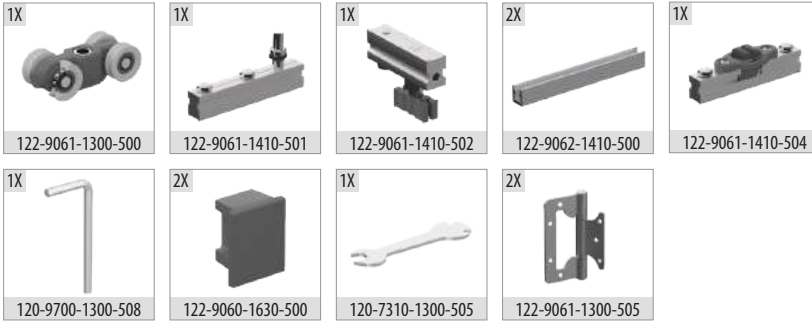

Ray Profilleri / Rail Profiles

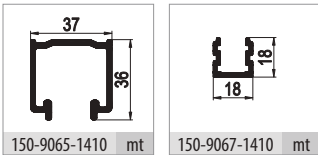

Uygulama / Application



Teknik Detay / Technical Detail

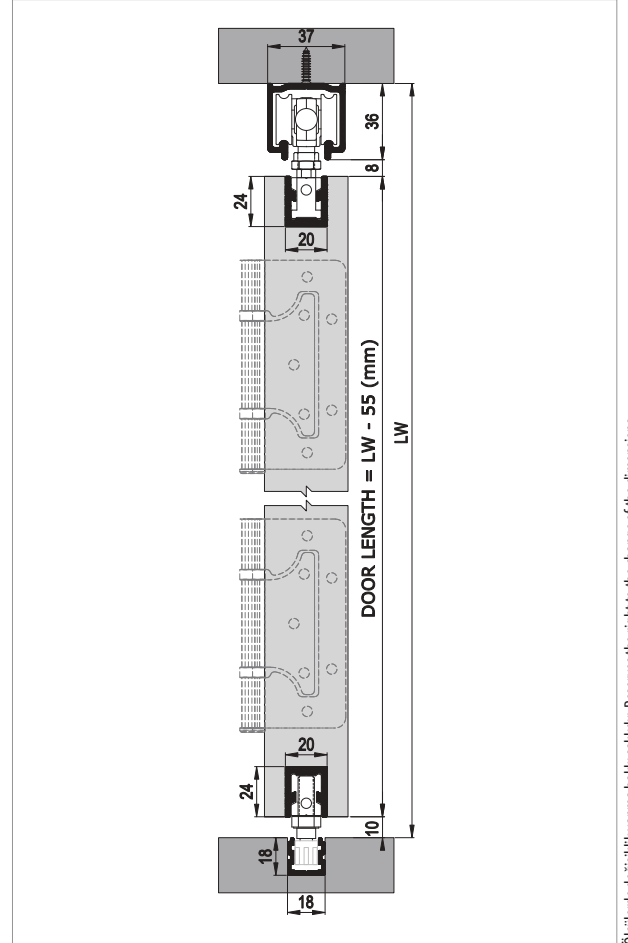

Ölçülerde değişiklik yapma hakkı saklıdır. Reserves the right to the change of the dimensions.

| Kod / Code No | Açıklama / Description | Renk / Colour | Birim / Unit | | | Profil mt. / Profiles mt. | Bağ / Bnd. |
|-------------------|--|------------------------|----------------|-----|-------|---------------------------|---------------|
| 122-9060-1410 | Masterfold 60 - Sabit Kanat / Foldable Heavy Door System | Gri / Grey | 1 Kapı / 1 Kit | 16 | 512 | - | - |
| 122-9062-1410 | Midfold 60 -Sürme Katlanır Kapı Sistemi / Sliding Foldable Heavy Door System | Gri / Grey | 1 Kapı / 1 Kit | 4 | 160 | - | - |
| 122-9061-1300-505 | Çelik Menteşe / Steel Hinge | Galvaniz / Galvanized | 1 Adet / 1 Pcs | 50 | 2.400 | - | - |
| 122-9300-1300-509 | Zemin Pivot Burcu Paslanmaz / Ground Pivot Stainless | Galvaniz / Galvanized | 1 Adet / 1 Pcs | 100 | 9.600 | - | - |
| 150-9065-1410 | Alüminyum Üst Ray Profili / Aluminium Top Rail Profile | Eloksal / Mat Anodized | mt. | - | - | - | 6,0 6 ad/pcs |
| 150-9067-1410 | Alüminyum Alt Klavuz / Aluminium Bottom Slider | Eloksal / Mat Anodized | mt. | - | - | - | 6,0 10 ad/pcs |

MasterFold 160

160 KG KATLANIR SÜRME KAPI SİSTEMİ • FOLDABLE DOOR MECHANISM - FOLDING DOOR



Bilgi / Information

- Minimum kapı panel kalınlığı 40 mm. olmalıdır.
- Door panel's thickness should be minimum 40 mm.



122-9300 1 Takım İçeriği / 1 Kit Includes

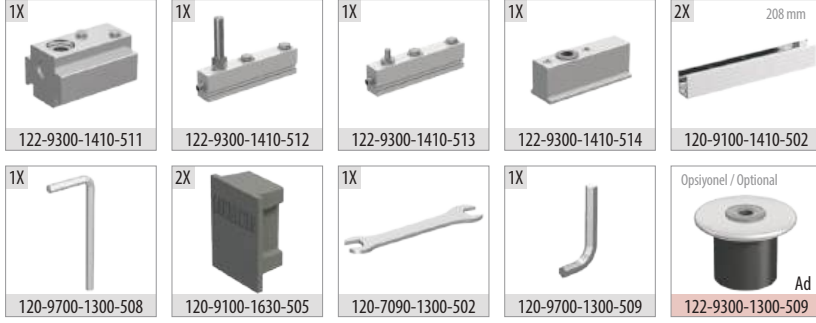

9400 1 Takım İçeriği / 1 Kit Includes



Ray Profilleri / Rail Profiles

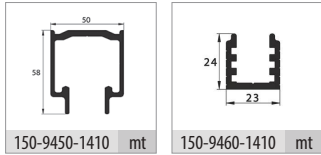

Opsiyonel / Optional

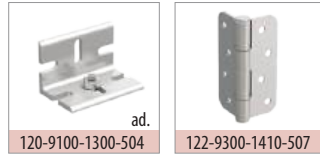

Uygulama / Application



Teknik Detay / Technical Detail

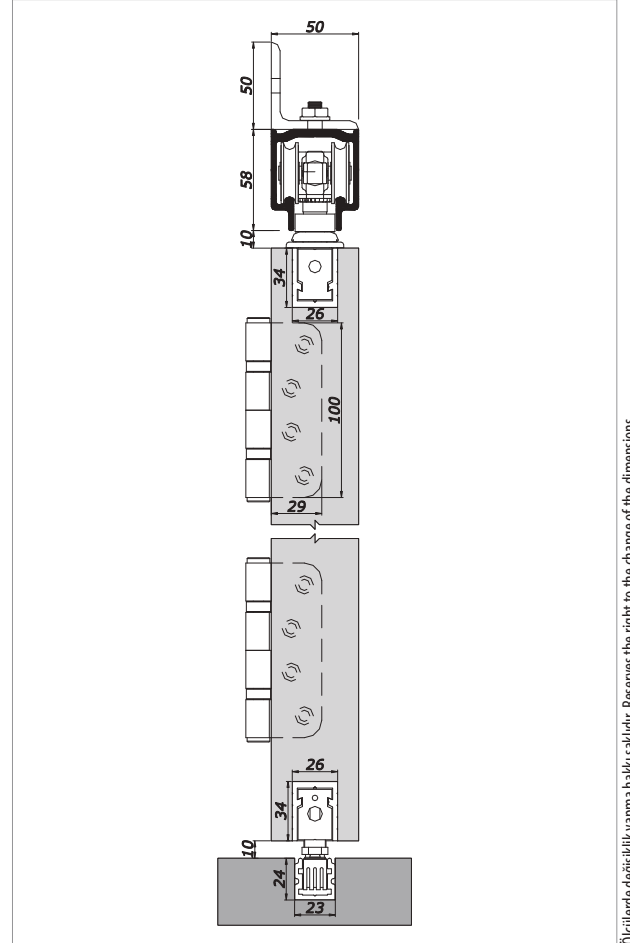

Ölçülerde değişiklik yapma hakkı saklıdır. Reserves the right to the change of the dimensions.

| Kod / Code No | Açıklama / Description | Renk / Colour | Birim / Unit | | | Profil mt. / Profiles mt. | | | Bağ / Bnd. |
|-------------------|---|------------------------|----------------|-----|-------|---------------------------|-----|-----|------------|
| 122-9300-1410 | Sabit Kanat / Foldable Heavy Door System | Gri / Grey | 1 Kapı / 1 Kit | 12 | 360 | - | - | - | - |
| 122-9400-1410 | 160 Kg Katlanır Kapı Sistemi / Foldable Heavy Door System | Gri / Grey | 1 Kapı / 1 Kit | 12 | 360 | - | - | - | - |
| 120-9100-1300-504 | Aski Aparatı / Hanger Parts | Galvaniz / Galvanized | 1 Adet / 1 Pcs | 50 | 2.400 | - | - | - | - |
| 122-9300-1300-509 | Zemin Pivot Burcu Paslanmaz / Ground Pivot Stainless | Galvaniz / Galvanized | 1 Adet / 1 Pcs | 100 | 9.600 | - | - | - | - |
| 150-9450-1410 | Alüminyum Üst Ray Profili / Aluminium Top Rail Profile | Eloksal / Mat Anodized | mt. | - | - | 2,0 | 3,0 | 6,0 | 2 ad/pcs |
| 150-9460-1410 | Alüminyum Alt Ray Profili / Aluminium Bottom Rail Profile | Eloksal / Mat Anodized | mt. | - | - | 2,0 | 3,0 | 6,0 | 8 ad/pcs |

MidFold 160

160 KG KATLANIR SÜRME KAPI SİSTEMİ • FOLDABLE DOOR MECHANISM - FOLDING DOOR



Bilgi / Information

- Minimum kapı panel kalınlığı 40 mm. olmalıdır.
- Door panel's thickness should be minimum 40 mm.



122-9300 1 Takım İçeriği / 1 Kit Includes

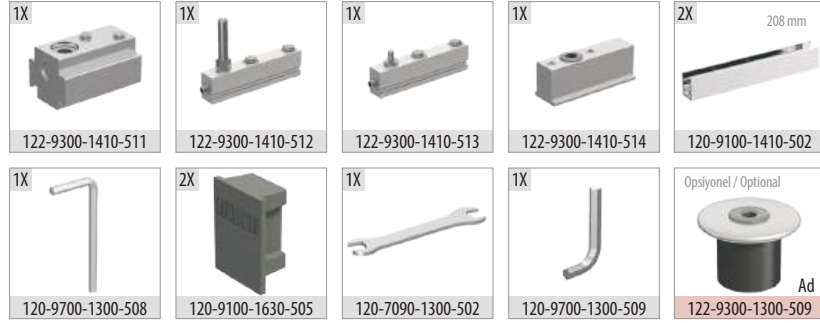

9500 1 Takım İçeriği / 1 Kit Includes



Ray Profilleri / Rail Profiles

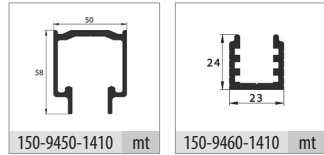

Opsiyonel / Optional

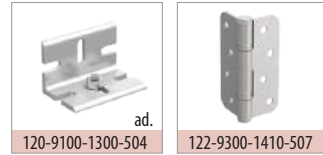

Uygulama / Application



Teknik Detay / Technical Detail

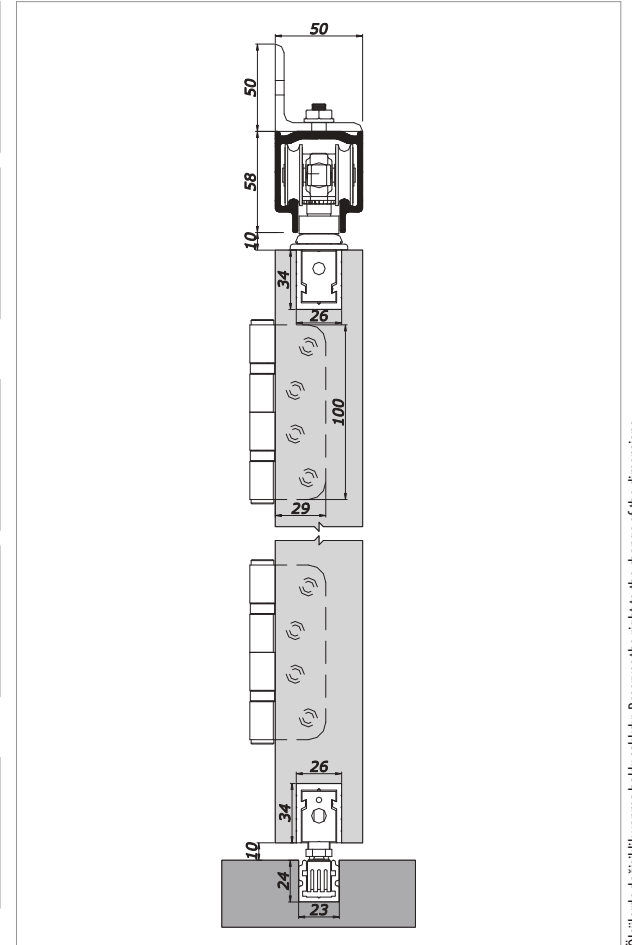

Ölçülerde değişiklik yapma hakkı saklıdır. Reserves the right to the change of the dimensions.

| Kod / Code No | Açıklama / Description | Renk / Colour | Birim / Unit | | | Profil mt. / Profiles mt. | | | Bağ / Bnd. |
|-------------------|---|------------------------|----------------|-----|-------|---------------------------|-----|-----|------------|
| 122-9300-1410 | Sabit Kanat / Foldable Heavy Door System | Gri / Grey | 1 Kapı / 1 Kit | 12 | 360 | - | - | - | - |
| 122-9500-1410 | Katlanır Kapı Sistemi / Foldable Heavy Door System | Gri / Grey | 1 Kapı / 1 Kit | 4 | 160 | - | - | - | - |
| 120-9100-1300-504 | Askı Aparatı / Hanger Parts | Galvaniz / Galvanized | 1 Adet / 1 Pcs | 50 | 2.400 | - | - | - | - |
| 122-9300-1300-509 | Zemin Pivot Burcu Paslanmaz / Ground Pivot Stainless | Galvaniz / Galvanized | 1 Adet / 1 Pcs | 100 | 9.600 | - | - | - | - |
| 150-9450-1410 | Alüminyum Üst Ray Profili / Aluminium Top Rail Profile | Eloksal / Mat Anodized | mt. | - | - | 2,0 | 3,0 | 6,0 | 2 ad/pcs |
| 150-9460-1410 | Alüminyum Alt Ray Profili / Aluminium Bottom Rail Profile | Eloksal / Mat Anodized | mt. | - | - | 2,0 | 3,0 | 6,0 | 8 ad/pcs |

122-1050-1800

KATLANIR KAPI KİLİT MEKANİZMASI • FOLDING DOOR LOCK MECHANISM

Yeni Ürün
New Product



1 Set İçeriği / 1 Set Includes

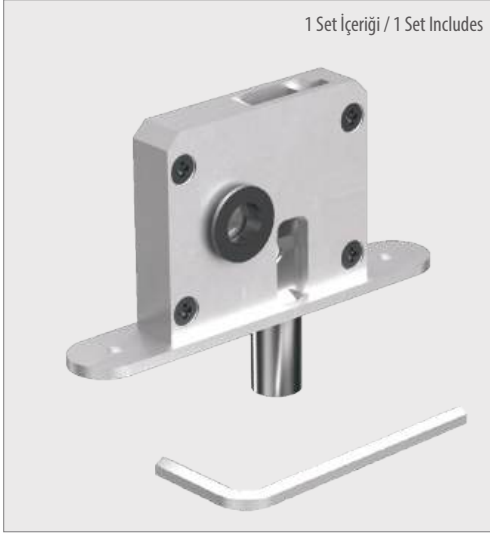

Bilgi / Information

- Katlanır kapı sistemleri için üretilmiş kilit mekanizmasıdır.
- Lock mechanism for folding door systems.



Teknik Detay / Technical Detail

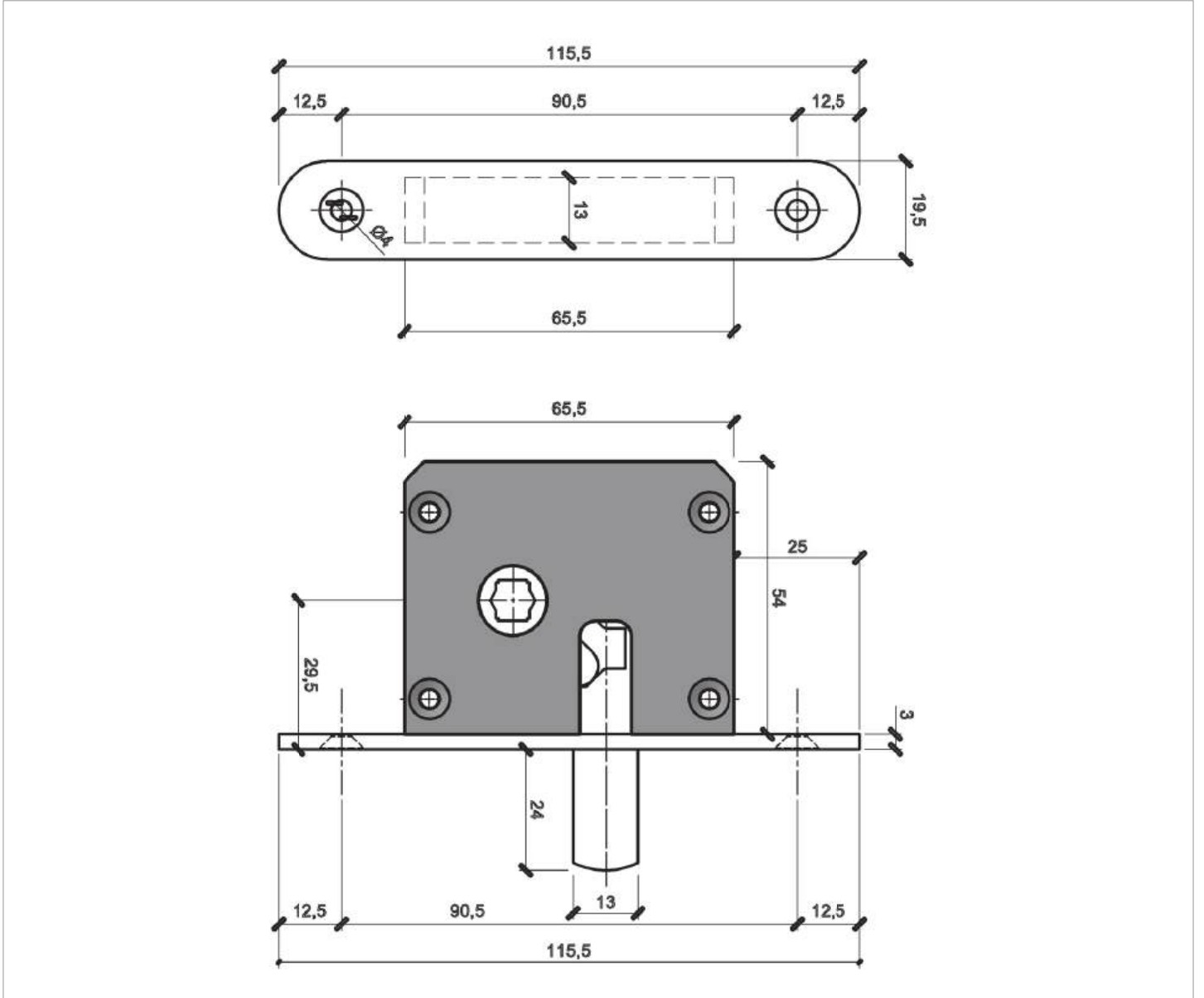

| Kod / Code No | Açıklama / Description | Renk / Colour | Birim / Unit | | |
|---------------|---|-----------------------|----------------|---|---|
| 122-1050-1800 | Katlanır Kapı Kilit Mekanizması • Folding Door Lock Mechanism | Galvaniz / Galvanized | 1 Adet / 1 Pcs | - | - |



1 Set İçeriği / 1 Set Includes



Bilgi / Information

- Katlanır kapı sistemleri için üretilmiş kilit mekanizmasıdır.
- Lock mechanism for folding door systems.

Teknik Detay / Technical Detail

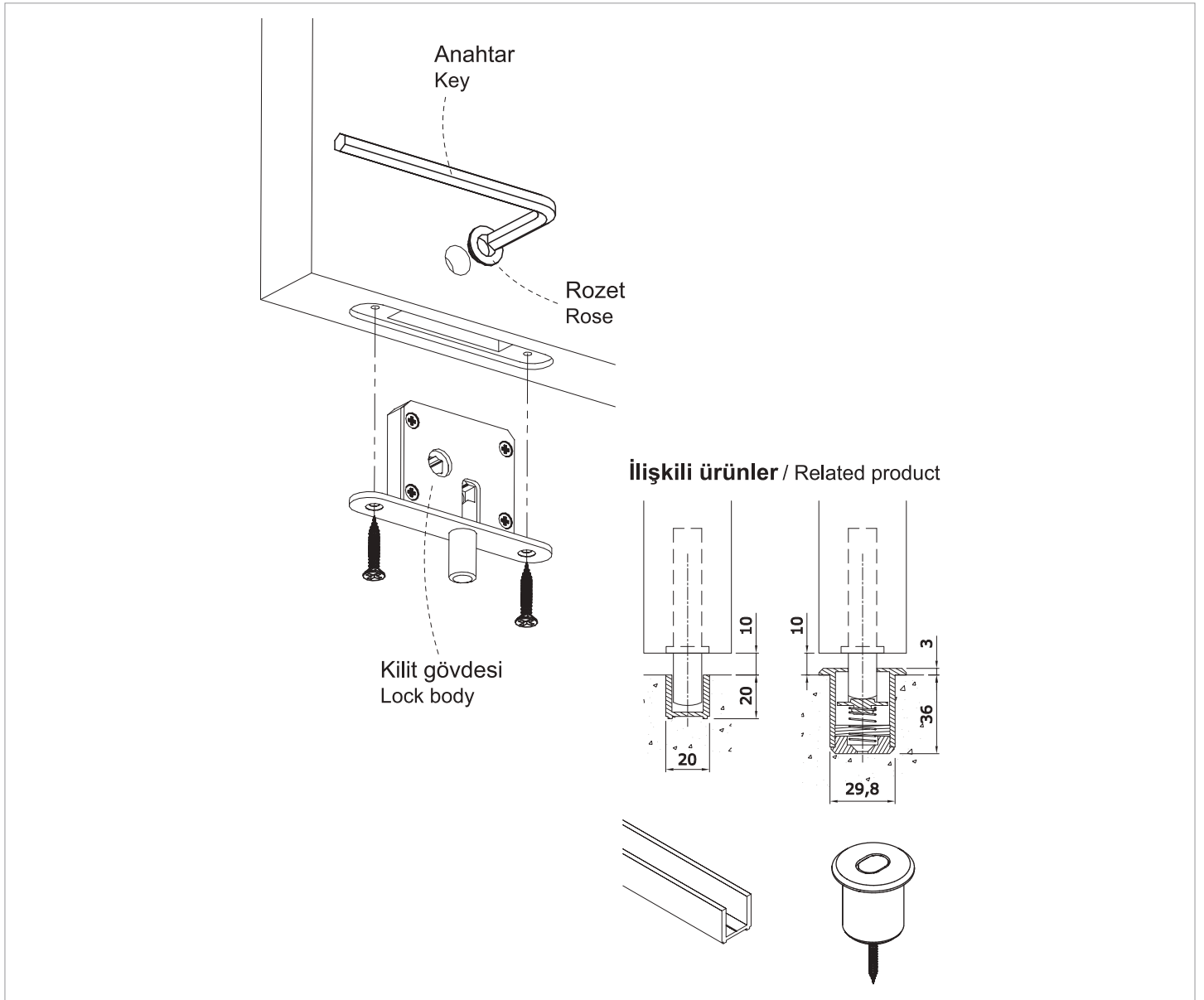

| Kod / Code No | Açıklama / Description | Renk / Colour | Birim / Unit | | |
|---------------|--------------------------------|-----------------------|----------------|---|---|
| 122-1052-1820 | Yer Soketi • Dust Proof Strike | Galvaniz / Galvanized | 1 Adet / 1 Pcs | - | - |

MasterFold 60

UYGULAMA ŞEMASI • APPLICATION SCHEME

MidFold 60

UYGULAMA ŞEMASI • APPLICATION SCHEME

| | | | |
|--|----------------------------|--|----------------------------|
| | 9060 - 1 Tk 9061 - 1 Tk | | 9060 - 1 Tk 9062 - 1 Tk |
| | 9060 - 1 Tk 9061 - 1 Tk | | 9060 - 2 Tk 9062 - 1 Tk |
| | 9060 - 2 Tk 9061 - 1 Tk | | 9060 - 1 Tk 9062 - 1 Tk |
| | 9060 - 2 Tk 9061 - 1 Tk | | 9060 - 2 Tk 9062 - 1 Tk |
| | 9060 - 1 Tk 9061 - 2 Tk | | 9060 - 1 Tk 9062 - 2 Tk |
| | 9060 - 1 Tk 9061 - 2 Tk | | 9060 - 2 Tk 9062 - 2 Tk |
| | 9060 - 2 Tk 9061 - 2 Tk | | 9060 - 1 Tk 9062 - 3 Tk |
| | 9060 - 1 Tk 9061 - 3 Tk | | 9060 - 2 Tk 9062 - 2 Tk |
| | 9060 - 2 Tk 9061 - 2 Tk | | 9060 - 1 Tk 9062 - 3 Tk |
| | 9060 - 1 Tk 9061 - 3 Tk | | 9060 - 2 Tk 9062 - 3 Tk |
| | 9060 - 2 Tk 9061 - 3 Tk | | 9060 - 2 Tk 9062 - 2 Tk |
| | 9060 - 2 Tk 9061 - 3 Tk | | 9060 - 2 Tk 9062 - 2 Tk |
| | 9060 - 1 Tk 9061 - 3 Tk | | 9060 - 2 Tk 9062 - 3 Tk |
| | 9060 - 2 Tk 9061 - 3 Tk | | 9060 - 2 Tk 9062 - 2 Tk |
| | 9060 - 2 Tk 9061 - 3 Tk | | 9060 - 2 Tk 9062 - 2 Tk |
| | 9060 - 2 Tk 9061 - 2 Tk | | 9060 - 2 Tk 9062 - 4 Tk |
| | 9060 - 2 Tk 9061 - 2 Tk | | 9060 - 2 Tk 9062 - 4 Tk |
| | 9060 - 2 Tk 9061 - 4 Tk | | 9060 - 2 Tk 9062 - 6 Tk |
| | 9060 - 2 Tk 9061 - 4 Tk | | 9060 - 2 Tk 9062 - 6 Tk |
| | 9060 - 2 Tk 9061 - 6 Tk | | |
| | 9060 - 2 Tk 9061 - 6 Tk | | |

- Yüksekliği 2.100 mm olan kanatlarda, kapı başına 2 adet menteşe kullanılmalıdır.
- Yüksekliği 2.100 - 2.500 mm'ye kadar kanatlarda, kapı başına 3 adet menteşe kullanılmalıdır.
- Yüksekliği 2.500 - 2.700 mm'ye kadar kanatlarda, kapı başına 4 adet menteşe önerilir.
- Minimum kapı genişliği 380 mm olmalıdır.
- Maksimum kapı genişliği 900 mm olmalıdır.
- Minimum ahşap kapı panel kalınlığı 36 mm olmalıdır.
- Alüminyum Profil kanatlarda min. kapı panel kalınlığı 25 mm olmalıdır.
- Maksimum yükseklik 2.700 mm olmalıdır.
- Montaj esnasında uygulamaya göre ilave menteşe talep edilebilir.





















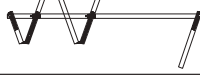





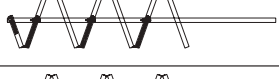



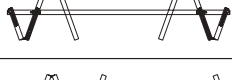

- 2.100 mm in height for doors, should be used 2 pcs hinge per door.
- Up to 2.100 - 2.500 mm in height for doors, 3 hinges should be used per door.
- Up to 2.500 - 2.700 mm in height for doors, 4 hinges should be used per door.
- Min. door width 380 mm
- Max. door width 900 mm
- Door panel's thickness should be min. 36 mm
- The minimum thickness should be 25mm on aluminum profile panel doors.
- Max. door hight 2.700 mm
- An additional hinge steel hinge can be requested during the assembly.

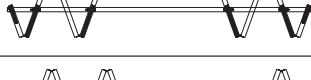
MasterFold 160

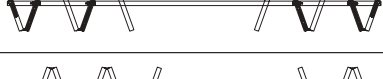
UYGULAMA ŞEMASI • APPLICATION SCHEME

MidFold 160

UYGULAMA ŞEMASI • APPLICATION SCHEME

| | | | |
|--|------------------------------|--|------------------------------|
|  | 9300 - 1 Tk. 9400 - 1 Tk. |  | 9300 - 1 Tk. 9500 - 1 Tk. |
|  | 9300 - 1 Tk. 9400 - 1 Tk. |  | 9300 - 2 Tk. 9500 - 1 Tk. |
|  | 9300 - 2 Tk. 9400 - 1 Tk. |  | 9300 - 1 Tk. 9500 - 1 Tk. |
|  | 9300 - 2 Tk. 9400 - 1 Tk. |  | 9300 - 2 Tk. 9500 - 1 Tk. |
|  | 9300 - 1 Tk. 9400 - 2 Tk. |  | 9300 - 1 Tk. 9500 - 2 Tk. |
|  | 9300 - 1 Tk. 9400 - 2 Tk. |  | 9300 - 2 Tk. 9500 - 2 Tk. |
|  | 9300 - 2 Tk. 9400 - 2 Tk. |  | 9300 - 1 Tk. 9500 - 3 Tk. |
|  | 9300 - 1 Tk. 9400 - 3 Tk. |  | 9300 - 2 Tk. 9500 - 2 Tk. |
|  | 9300 - 2 Tk. 9400 - 2 Tk. |  | 9300 - 1 Tk. 9500 - 3 Tk. |
|  | 9300 - 1 Tk. 9400 - 3 Tk. |  | 9300 - 2 Tk. 9500 - 3 Tk. |
|  | 9300 - 2 Tk. 9400 - 3 Tk. |  | 9300 - 2 Tk. 9500 - 2 Tk. |
|  | 9300 - 2 Tk. 9400 - 3 Tk. |  | 9300 - 2 Tk. 9500 - 2 Tk. |
|  | 9300 - 2 Tk. 9400 - 2 Tk. |  | 9300 - 2 Tk. 9500 - 4 Tk. |
|  | 9300 - 2 Tk. 9400 - 2 Tk. |  | 9300 - 2 Tk. 9500 - 4 Tk. |
|  | 9300 - 2 Tk. 9400 - 4 Tk. |  | 9300 - 2 Tk. 9500 - 6 Tk. |
|  | 9300 - 2 Tk. 9400 - 4 Tk. |  | 9300 - 2 Tk. 9500 - 6 Tk. |
|  | 9300 - 2 Tk. 9400 - 6 Tk. | | |
|  | 9300 - 2 Tk. 9400 - 6 Tk. | | |

* Yüksekliği 2500 mm olan kanatlarda, kapı başına 2 adet 122-9300-1410-507 kullanılmalıdır.

* Yüksekliği 2500 mm'den büyük kanatlarda, kapı başına 3 adet 122-9300-1410-507 kullanılmalıdır.

* Minimum kapı genişliği 550 mm olmalıdır.

* Maksimum kapı genişliği 950 mm olmalıdır.

* Minimum kapı panel kalınlığı 40 mm olmalıdır.

* Maksimum yükseklik 2.700 mm olmalıdır.

* Montaj esnasında uygulamaya göre ilave 122-9300-1410-507 menteşe talep edilebilir.

* 2500 mm in height for doors, should be used 2 pcs 122-9300-1410-507 per door

* More than height 2500 mm for doors, should be used 3 pcs 122-9300-1410-507 per door

* Min. door width 550 mm

* Max. door width 950 mm

* Door panel's thickness should be min. 40 mm

* Max. door height 2.700 mm

* An additional 122-9300-1410-507 steel hinge can be requested during the assembly.





MidFold 160

KATLANIR SÜRME KAPI SİSTEMİ • FOLDABLE DOOR MECHANISM - FOLDING DOOR

albaturas.com

Group 123

GlassDoor®

Cam Sürme Kapı Serisi

Glass Door Sliding Series



Bu serideki tüm ürünleri incelemek için QR kodu okutabilirsiniz.

You can search the QR code to see all the products in these series.

GlassDoor

CAM SÜRME KAPI SERİSİ • GLASS DOOR SLIDING SERIES

Group **123**



GlassDoor **9906**



GlassDoor **9912**



GlassDoor **9910**



GlassDoor **9911**



GlassDoor **9900**



GlassDoor **9901**



GlassDoor **9030**



GlassDoor **9035**



GlassDoor **9902**



GlassDoor **9903**



GlassDoor **9920**



GlassDoor **9921**

GlassDoor 9906

60 KG ÇİFT YÖNE YAVAŞLATICILI SÜRME CAM KAPI SİSTEMİ • SLIDING GLASS DOOR SYSTEM - TWO WAY SOFT CLOSING

YeniÜrün
NewProduct

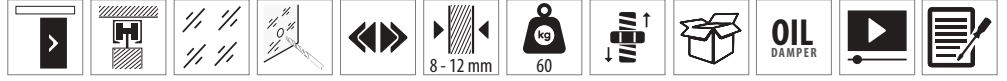

Bilgi / Information

- Minimum kapı genişliği 580 mm olmalıdır.
- Min. Door width 580 mm

Yavaşlatıcı Alternatifi / Soft Closer Alternative

- Sistem üzerinde tek yöne yavaşlatıcı mevcuttur.
- The system has one way soft closing.



123-9906 1 Takım İçeriği / 1 Kit Includes

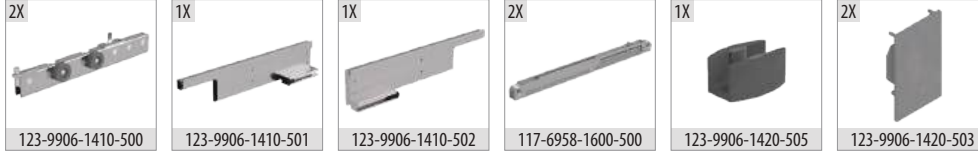

Ray Profilleri / Rail Profiles



Teknik Detay / Technical Detail

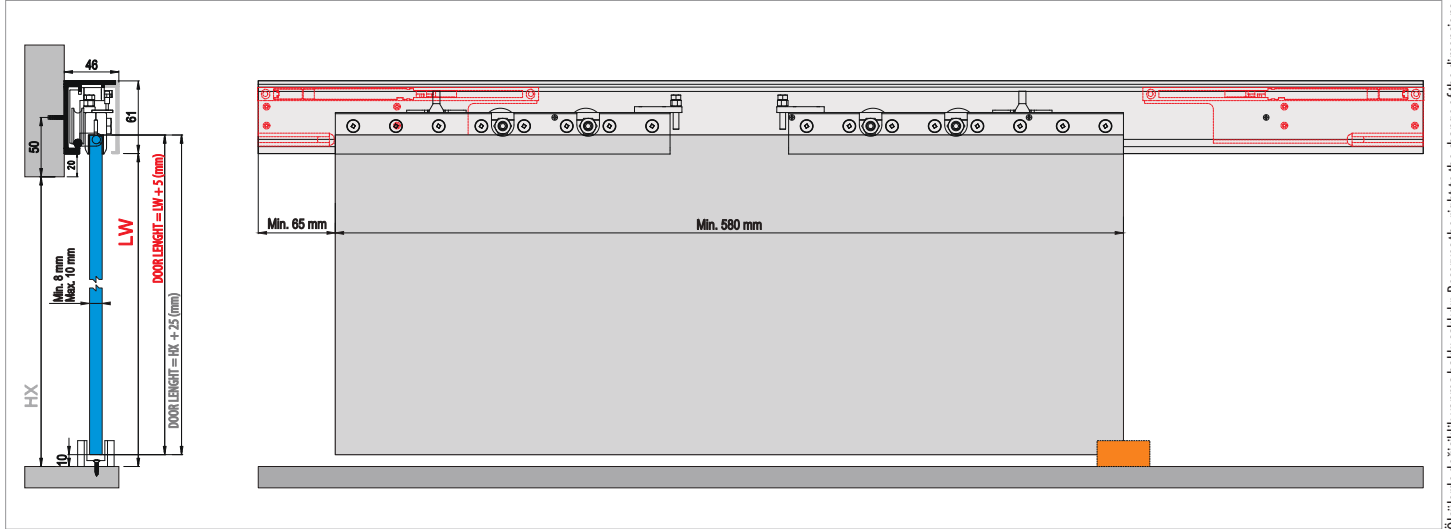

Ölçülerde değişiklik yapma hakkı saklıdır. Reserves the right to the change of the dimensions.

Uygulama / Application



| Kod / Code No | Açıklama / Description | Renk / Colour | Birim / Unit | | | Profil mt. / Profiles mt. | | | Bağ / Bnd. |
|---------------|--|------------------------|----------------|---|-----|---------------------------|-----|---|------------|
| 123-9906-1410 | 60 Kg Yavaşlatıcı Sürü Cam Kapı Sistemi / Sliding Glass Door System Has Soft Closing | Gri / Grey | 1 Kapı / 1 Kit | 4 | 192 | - | - | - | - |
| 150-7006-1411 | Alüminyum Üst Ray Profili / Aluminium Top Rail Profile | Eloksal / Mat Anodized | mt. | - | - | 2,0 | 3,0 | - | 6 ad/pcs |
| 150-7007-1411 | Alüminyum Alın Kapama Profili / Aluminum Covering Profile | Eloksal / Mat Anodized | mt. | - | - | 2,0 | 3,0 | - | 6 ad/pcs |

GlassDoor 9910

80 KG SÜRGÜ CAM KAPI SİSTEMİ • SLIDING GLASS DOOR SYSTEM

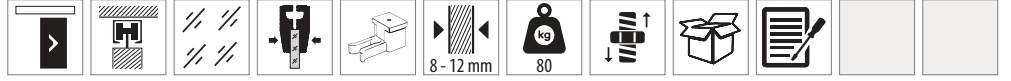

123-9910 1 Takım İçeriği / 1 Kit Includes

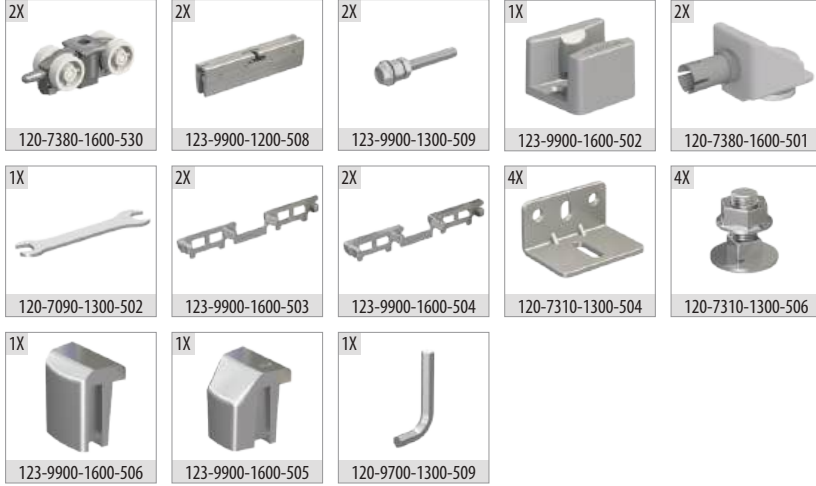

Ray Profilleri / Rail Profiles

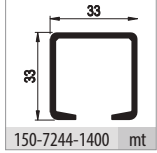

Uygulama / Application



Teknik Detay / Technical Detail

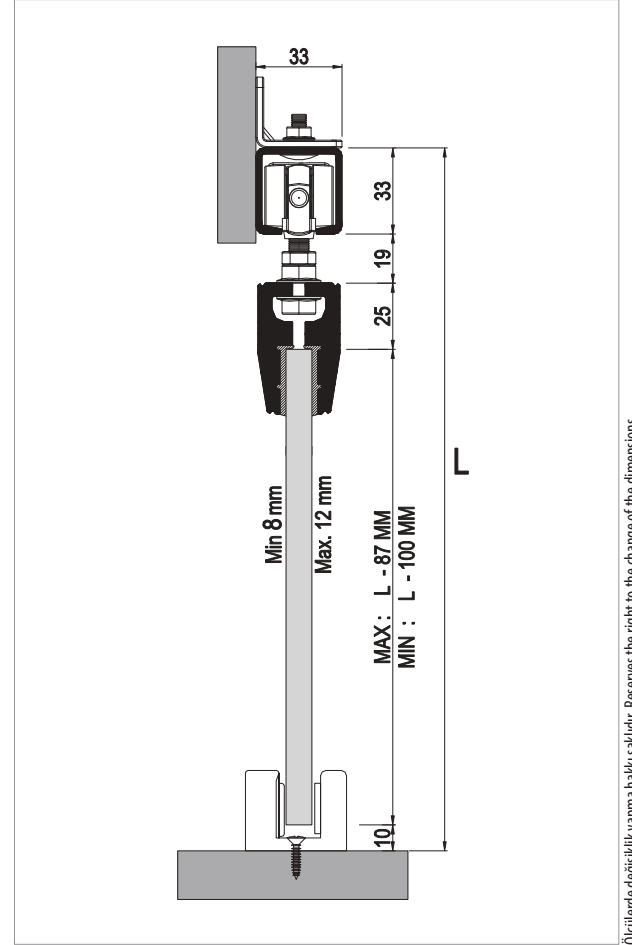

Ölçülerde değişiklik yapma hakkı saklıdır. Reserves the right to the change of the dimensions.

| Kod / Code No | Açıklama / Description | Renk / Colour | Birim / Unit | | | Profil mt. / Profiles mt. | Bağ / Bnd. |
|---------------|--|-----------------|----------------|----|-----|---------------------------|------------|
| 123-9910-1200 | 80 Kg Sürgü Cam Kapı Sistemi / Sliding Glass Door System | Gri / Grey | 1 Kapı / 1 Kit | 12 | 216 | - - - | - |
| 150-7244-1400 | Alüminyum Üst Ray Profili / Aluminium Top Rail Profile | Pres / Uncoated | mt | - | - | 2,0 - 3,0 | 6 ad/pcs |

GlassDoor 9911

80 KG SÜRGÜ CAM KAPI SİSTEMİ • GLASS SLIDING DOOR SYSTEM

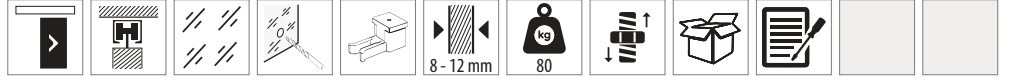

Bilgi / Information

- Bu ürün camda delme işlemi gerektirmektedir.
- This product need drilling on the glass.



123-9911 1 Takım İçeriği / 1 Kit Includes

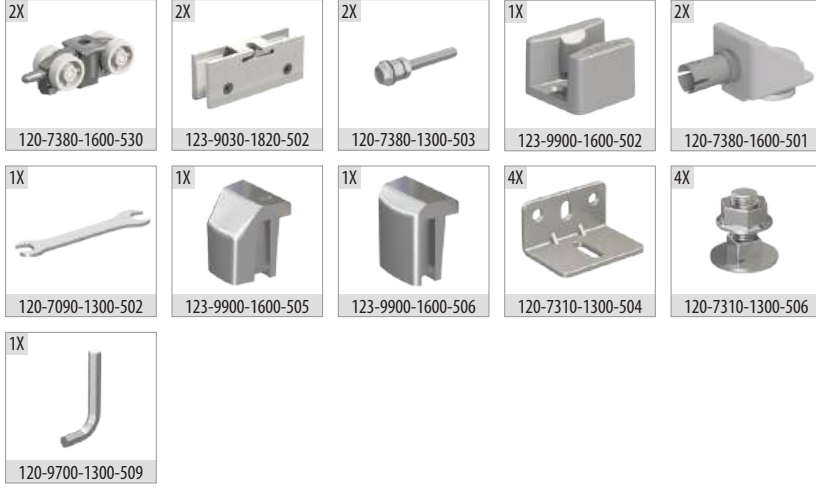

Ray Profilleri / Rail Profiles

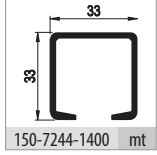

Teknik Detay / Technical Detail

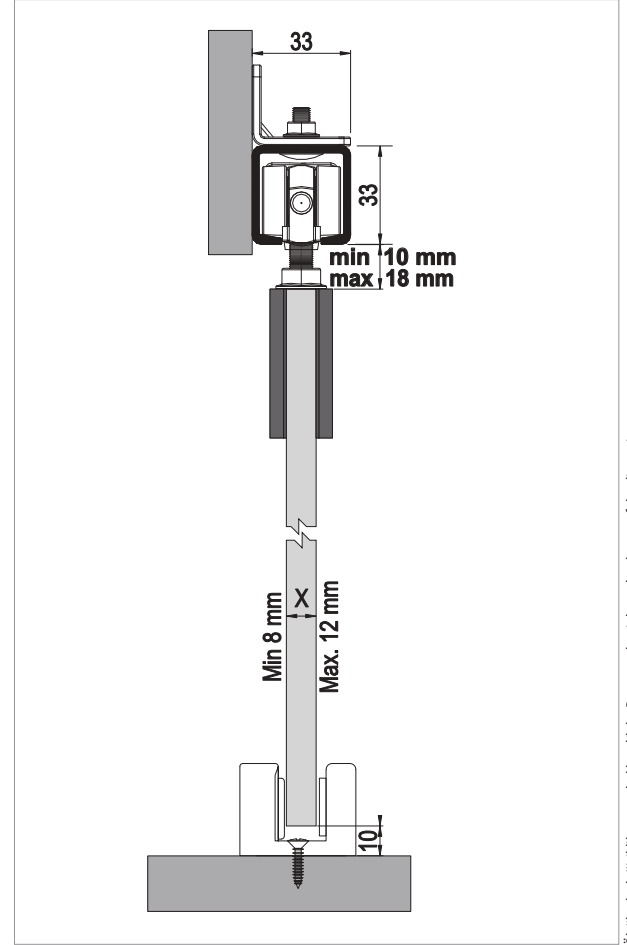

Ölçülerde değişiklik yapma hakkı saklıdır. Reserves the right to the change of the dimensions.

| Kod / Code No | Açıklama / Description | Renk / Colour | Birim / Unit | | | Profil mt. / Profiles mt. | Bağ / Bnd. | | |
|---------------|--|-----------------|----------------|----|-----|---------------------------|------------|-----|----------|
| 123-9911-1820 | 80 Kg Sürgü Cam Kapi Sistemi / Sliding Glass Door System | Gri / Grey | 1 Kapi / 1 Kit | 12 | 216 | - | - | - | |
| 150-7244-1400 | Alüminyum Üst Ray Profili / Aluminium Top Rail Profile | Pres / Uncoated | mt | - | - | 2,0 | - | 3,0 | 6 ad/pcs |

GlassDoor 9900

120 KG SÜRGÜ CAM KAPI SİSTEMİ • SLIDING GLASS DOOR SYSTEM

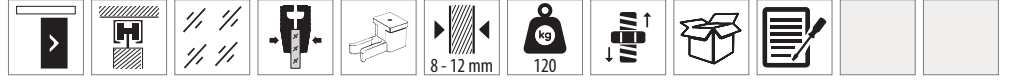

123-9900 1 Takım İçeriği / 1 Kit Includes

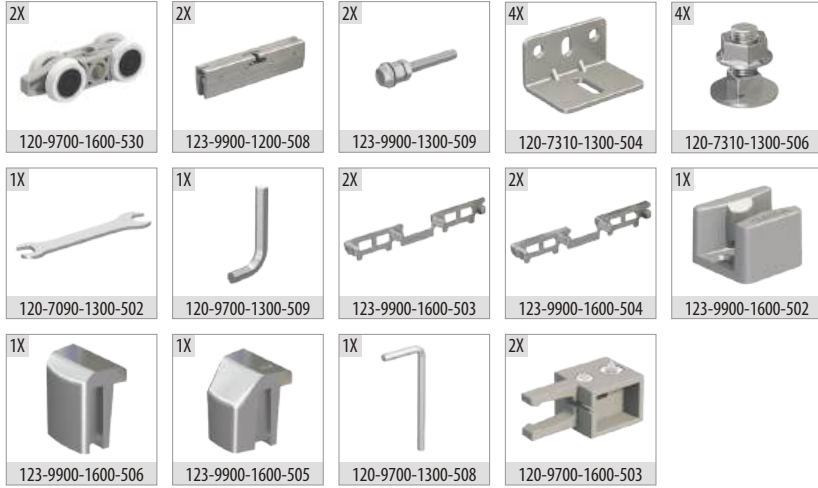

Ray Profilleri / Rail Profiles

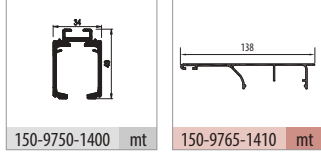

Uygulama / Application



Teknik Detay / Technical Detail

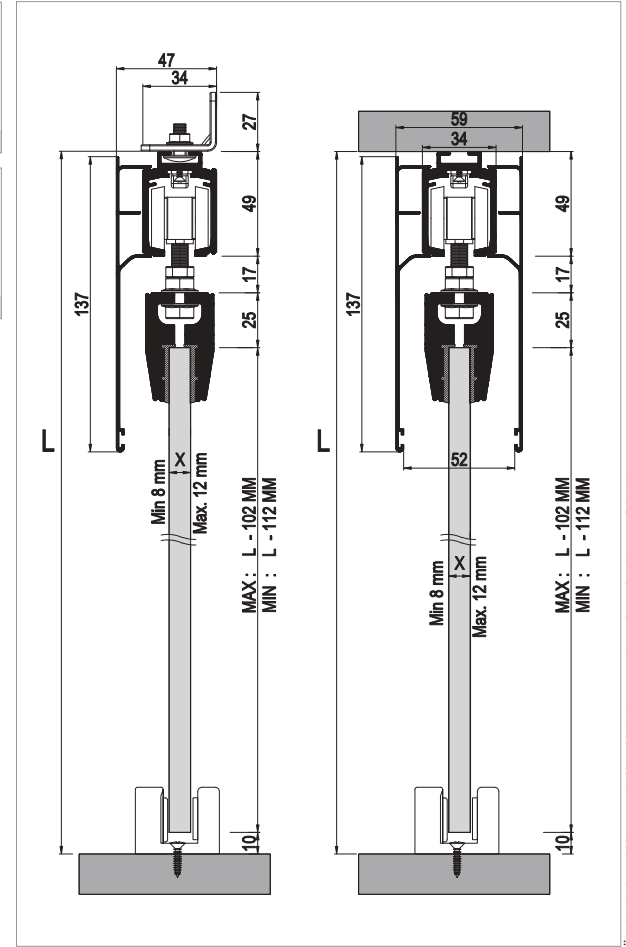

Ölçülerde değişiklik yapma hakkı saklıdır. Reserves the right to the change of the dimensions.

| Kod / Code No | Açıklama / Description | Renk / Colour | Birim / Unit | | | Profil mt. / Profiles mt. | Bağ / Bnd. |
|---------------|---|------------------------|----------------|----|-----|---------------------------|------------|
| 123-9900-1200 | 120 Kg Sürgü Cam Kapi Sistemi / Sliding Glass Door System | Gri / Grey | 1 Kapi / 1 Kit | 12 | 216 | - | - |
| 150-9750-1400 | Alüminyum Üst Ray Profili / Aluminium Top Rail Profile | Pres / Uncoated | mt | - | - | 2,0 | 3,0 |
| 150-9765-1410 | Alüminyum Alın Kapama / Aluminium Cover Front | Eloksal / Mat Anodized | mt | - | - | 2,0 | 3,0 |

GlassDoor 9901

120 KG SÜRGÜ CAM KAPI SİSTEMİ • GLASS SLIDING DOOR SYSTEM

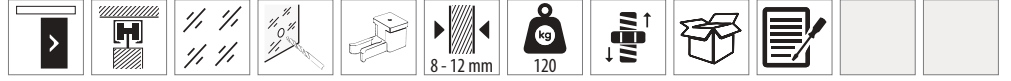

Bilgi / Information

- Bu ürün camda delme işlemi gerektirmektedir.
- This product need drilling on the glass.



123-9901 1 Takım İçeriği / 1 Kit Includes

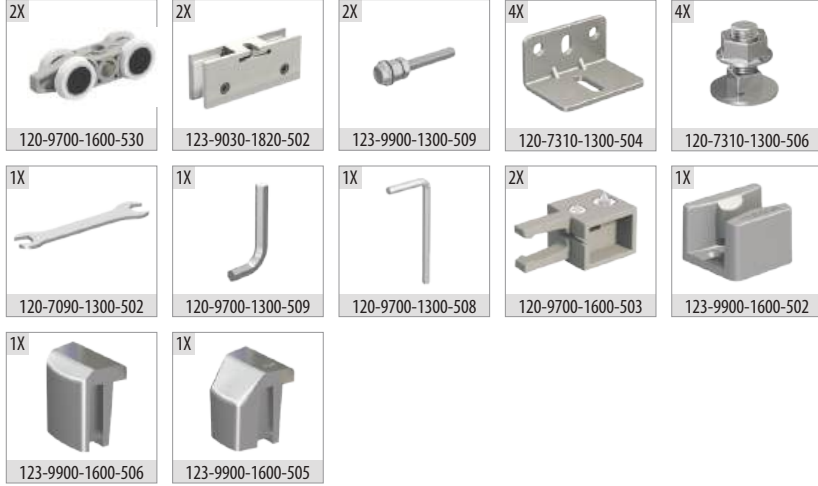

Ray Profilleri / Rail Profiles

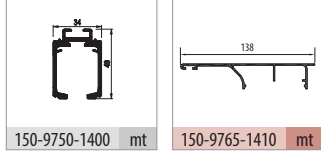

Uygulama / Application



Teknik Detay / Technical Detail

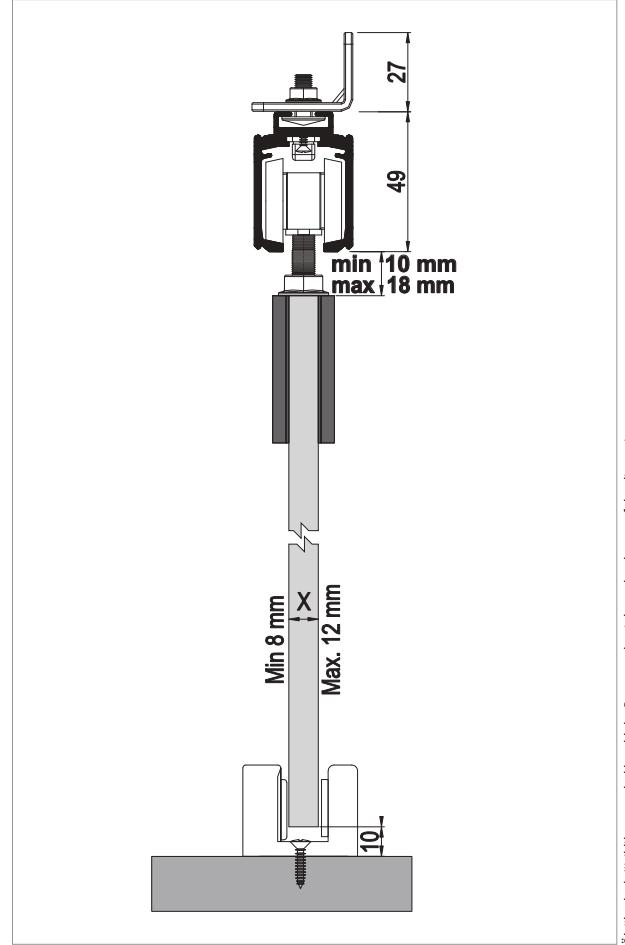

Ölçülerde değişiklik yapma hakkı saklıdır. Reserves the right to the change of the dimensions.

| Kod / Code No | Açıklama / Description | Renk / Colour | Birim / Unit | | | Profil mt. / Profiles mt. | Bağ / Bnd. | | |
|---------------|---|------------------------|----------------|----|-----|---------------------------|------------|-----|----------|
| 123-9901-1820 | 120 Kg Sürgü Cam Kapı Sistemi / Sliding Glass Door System | Gri / Grey | 1 Kapı / 1 Kit | 12 | 216 | - | - | - | |
| 150-9750-1400 | Alüminyum Üst Ray Profili / Aluminium Top Rail Profile | Pres / Uncoated | mt | - | - | 2,0 | - | 3,0 | 2 ad/pcs |
| 150-9765-1410 | Alüminyum Alın Kapama / Aluminium Cover Front | Eloksal / Mat Anodized | mt | - | - | 2,0 | - | 3,0 | 2 ad/pcs |

GlassDoor 9030

60 KG ÇİFT YÖNE YAVAŞLATICILI SÜRME CAM KAPI SİSTEMİ • SLIDING GLASS DOOR SYSTEM - TWO WAY SOFT CLOSING

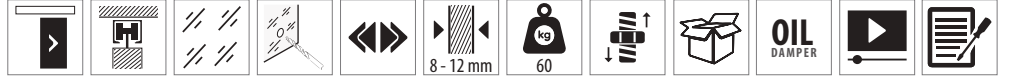

Bilgi / Information

- Minimum kapı genişliği 650 mm olmalıdır.
- Bu ürün camda delme işlemi gerektirmektedir.
- Min. Door width 650 mm
- This product need drilling on the glass.

Yavaşlatıcı Alternatifi / Soft Closer Alternative

- Sistem üzerinde çift yöne yavaşlatıcı mevcuttur.
- The system has two way soft closing.



123-9030 1 Takım İçeriği / 1 Kit Includes

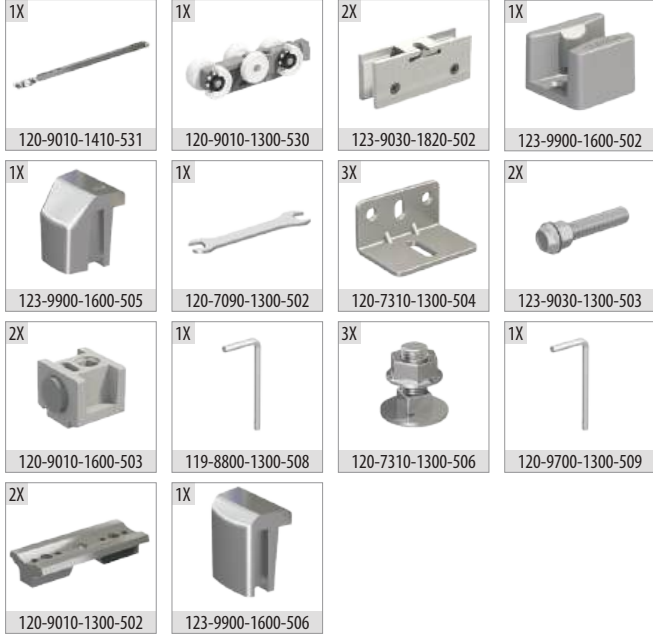

Ray Profilleri / Rail Profiles

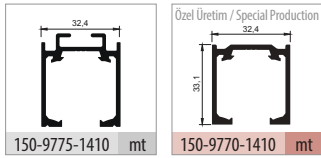

Uygulama / Application



Teknik Detay / Technical Detail

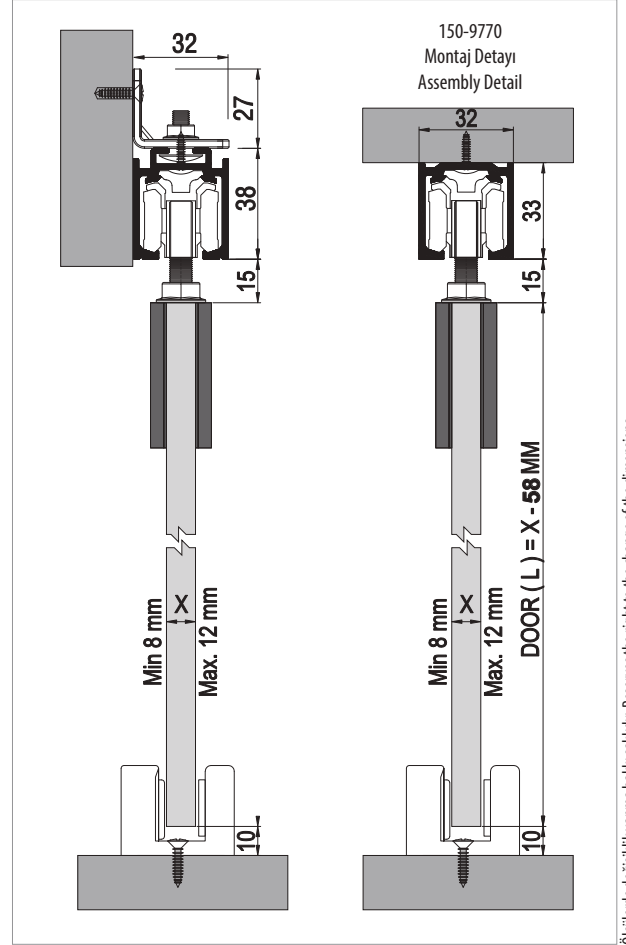

Ölçülerde değişiklik yapma hakkı saklıdır. Reserves the right to the change of the dimensions.

| Kod / Code No | Açıklama / Description | Renk / Colour | Birim / Unit | | | Profil mt. / Profiles mt. | Bağ / Bnd. |
|---------------|---|------------------------|----------------|---|-----|---------------------------|------------|
| 123-9030-1820 | 60 Kg Yavaşlatıcılı Sürgü Cam Kapı Sistemi / Sliding Glass Door System Has Soft Closing | Gri / Grey | 1 Kapı / 1 Kit | 4 | 192 | - | - |
| 150-9775-1410 | Alüminyum Üst Ray Profili / Aluminium Top Rail Profile | Eloksal / Mat Anodized | mt. | - | - | 2,0 3,0 | 6 ad/pcs |

GlassDoor 9035

60 KG ÇİFT YÖNE YAVAŞLATICILI SÜRME CAM KAPI SİSTEMİ • SLIDING GLASS DOOR SYSTEM - TWO WAY SOFT CLOSING



Bilgi / Information

- Minimum kapı genişliği 750 mm olmalıdır.
- Min. Door width 750 mm

Yavaşlatıcı Alternatifi / Soft Closer Alternative

- Sistem üzerinde çift yöne yavaşlatıcı mevcuttur.
- The system has two way soft closing.



123-9035 1 Takım İçeriği / 1 Kit Includes

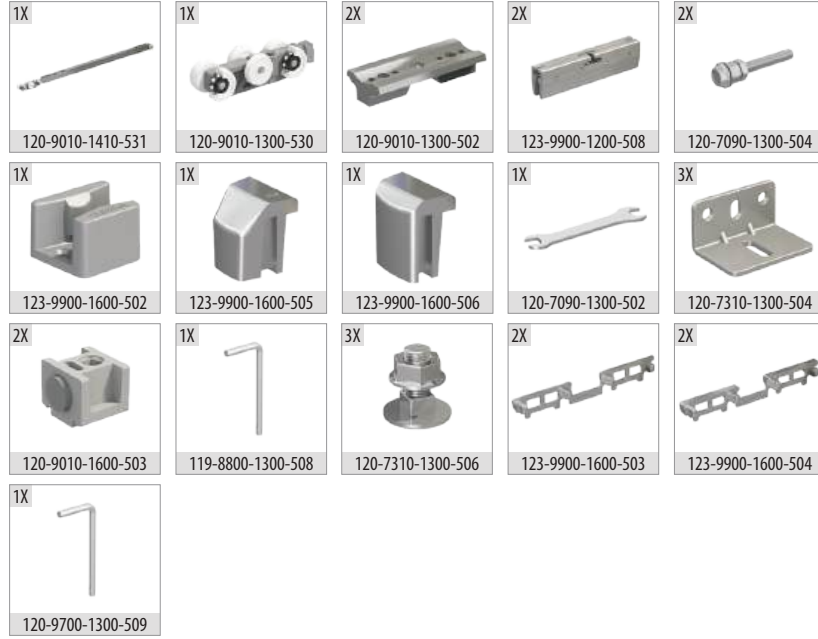

Ray Profilleri / Rail Profiles

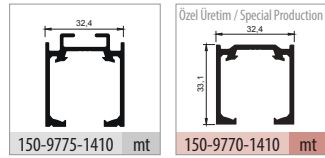

Uygulama / Application



Teknik Detay / Technical Detail

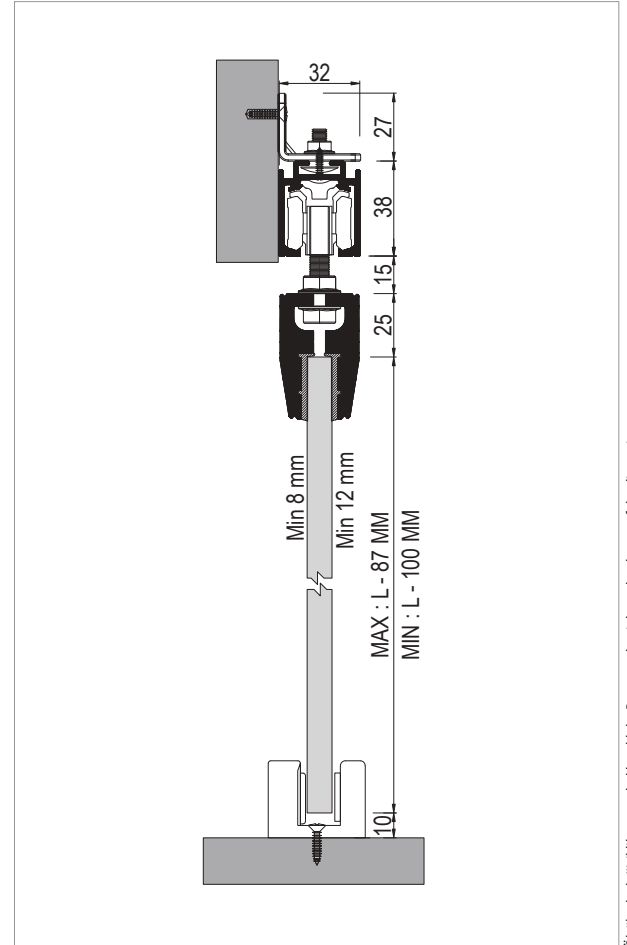

Ölçülerde değişiklik yapma hakkı saklıdır. Reserves the right to the change of the dimensions.

| Kod / Code No | Açıklama / Description | Renk / Colour | Birim / Unit | | | Profil mt. / Profiles mt. | Bağ / Bnd. | |
|---------------|---|------------------------|----------------|---|-----|---------------------------|------------|----------|
| 123-9035-1300 | 60 Kg Yavaşlatıcılı Sürgü Cam Kapı Sistemi / Sliding Glass Door System Has Soft Closing | Gri / Grey | 1 Kapı / 1 Kit | 4 | 192 | - | - | - |
| 150-9775-1410 | Alüminyum Üst Ray Profili / Aluminium Top Rail Profile | Eloksal / Mat Anodized | mt. | - | - | 2,0 | 3,0 | 6 ad/pcs |

GlassDoor 9902

120 KG AY.TEK YÖNE YAVAŞLATICILI SÜRGÜ CAM KAPI SİSTEMİ - ADJUSTABLE GLASS SLIDING DOOR SYSTEM ONE WAY SOFT CLOSING

9900 SFT

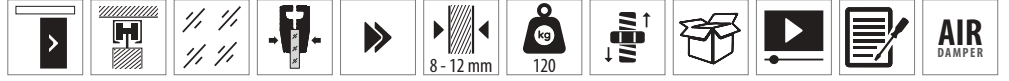

Bilgi / Information

- Minimum kapı genişliği 600 mm olmalıdır.
- Min. Door width 600 mm

Yavaşlatıcı Alternatifi / Soft Closer Alternative

- Sistem üzerinde tek yöne yavaşlatıcı mevcuttur.
- The system has one way soft closing.



123-9902 1 Takım İçeriği / 1 Kit Includes



Ray Profilleri / Rail Profiles

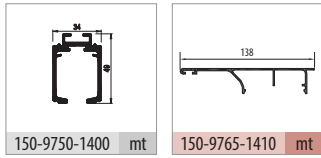

Uygulama / Application



Teknik Detay / Technical Detail

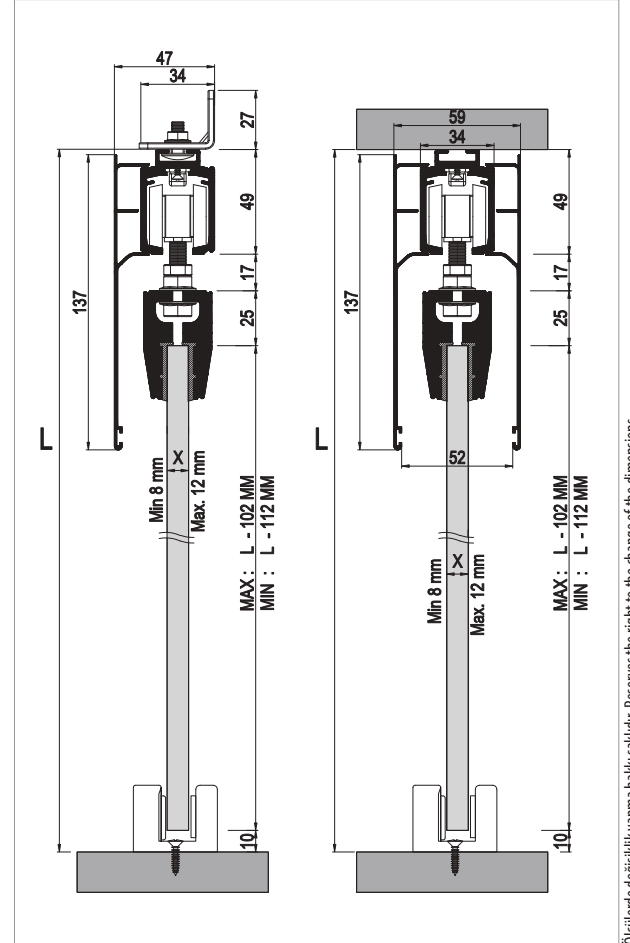

Ölçülerde değişiklik yapma hakkı saklıdır. Reserves the right to the change of the dimensions.

| Kod / Code No | Açıklama / Description | Renk / Colour | Birim / Unit | | | Profil mt. / Profiles mt. | Bağ / Bnd. |
|---------------|--|------------------------|----------------|----|-----|---------------------------|------------|
| 123-9902-1200 | 120 Kg Yavaşlatıcılı Sürgü Cam Kapı Sistemi / Sliding Glass Door System Has Soft Closing | Gri / Grey | 1 Kapı / 1 Kit | 12 | 216 | - - - | - |
| 150-9750-1400 | Alüminyum Üst Ray Profili / Aluminium Top Rail Profile | Pres / Uncoated | mt | - | - | 2,0 - 3,0 | 2 ad/pcs |
| 150-9765-1410 | Alüminyum Alın Kapama / Aluminium Cover Front | Eloksal / Mat Anodized | mt | - | - | 2,0 - 3,0 | 2 ad/pcs |

GlassDoor 9903

120 KG TEK YÖNE YAVAŞLATICILI SÜRGÜ CAM KAPI SİSTEMİ • GLASS SLIDING DOOR SYSTEM ONE WAY SOFT CLOSING

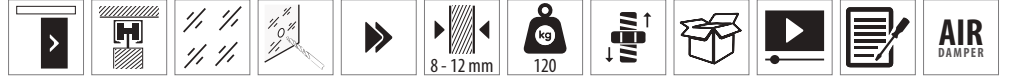

Bilgi / Information

- Minimum kapı genişliği 600 mm olmalıdır.
- Bu ürün camda delme işlemi gerektirmektedir.
- Min. Door width 600 mm
- This product need drilling on the glass.

Yavaşlatıcı Alternatifi / Soft Closer Alternative

- Sistem üzerinde çift yöne yavaşlatıcı mevcuttur.
- The system has two way soft closing.



123-9903 1 Takım İçeriği / 1 Kit Includes

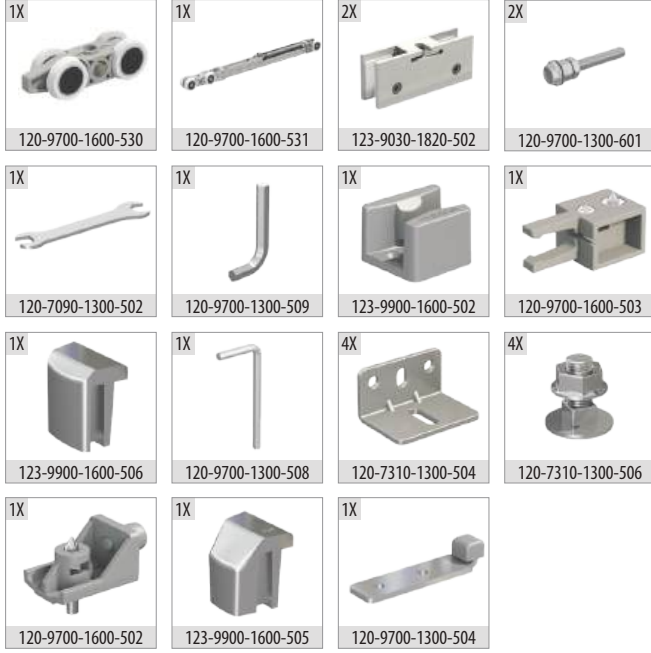

Ray Profilleri / Rail Profiles

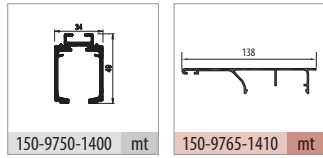

Uygulama / Application



Teknik Detay / Technical Detail

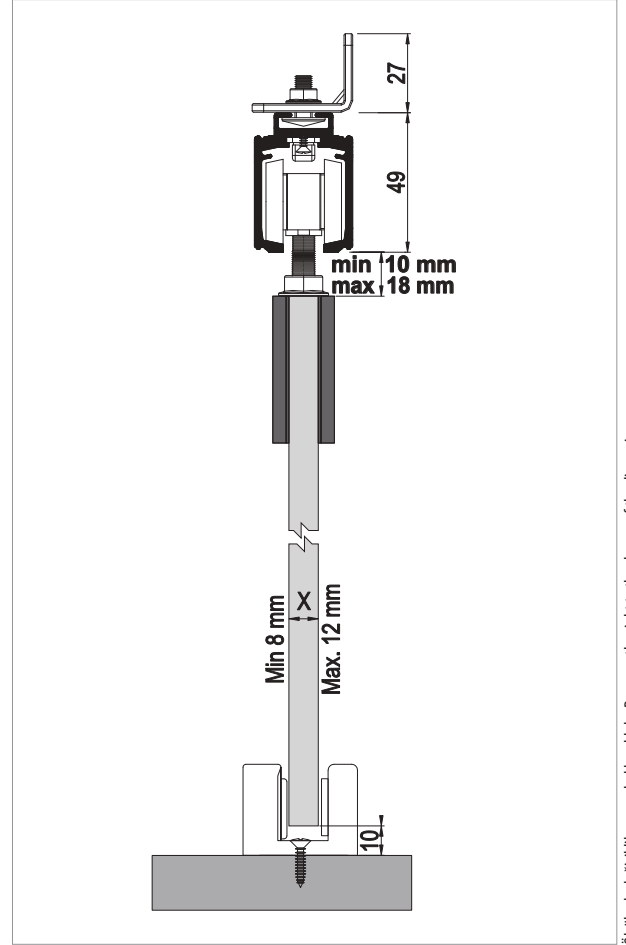

| Kod / Code No | Açıklama / Description | Renk / Colour | Birim / Unit | | | Profil mt. / Profiles mt. | | | Bağ / Bnd. |
|---------------|--|------------------------|----------------|----|-----|---------------------------|---|-----|------------|
| 123-9903-1820 | 120 Kg Yavaşlatıcılı Sürgü Cam Kapı Sistemi / Sliding Glass Door System Has Soft Closing | Gri / Grey | 1 Kapı / 1 Kit | 12 | 216 | - | - | - | - |
| 150-9750-1400 | Alüminyum Üst Ray Profili / Aluminium Top Rail Profile | Pres / Uncoated | mt | - | - | 2,0 | - | 3,0 | 2 ad/pcs |
| 150-9765-1410 | Alüminyum Alın Kapama / Aluminium Cover Front | Eloksal / Mat Anodized | mt | - | - | 2,0 | - | 3,0 | 2 ad/pcs |

GlassDoor 9920

120 KG ÇİFT YÖNE YAVAŞLATICILI SÜRGÜ CAM KAPI SİSTEMİ • GLASS SLIDING DOOR SYSTEM TWO WAY SOFT CLOSING

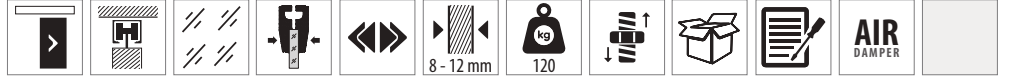

Bilgi / Information

- Minimum kapı genişliği 900 mm olmalıdır.
- Min. Door width 900 mm

Yavaşlatıcı Alternatifi / Soft Closer Alternative

- Sistem üzerinde çift yöne yavaşlatıcı mevcuttur.
- The system has two way soft closing.



123-9920 1 Takım İçeriği / 1 Kit Includes

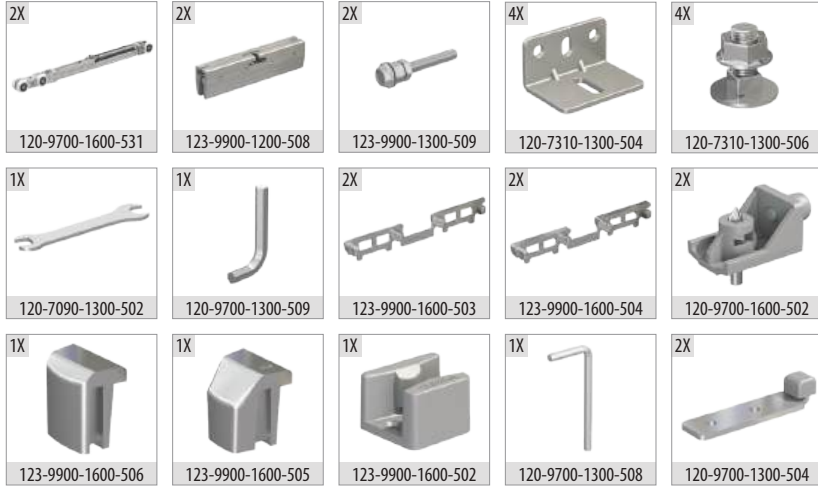

Ray Profilleri / Rail Profiles

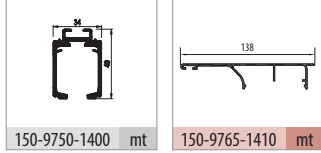

Uygulama / Application



Teknik Detay / Technical Detail

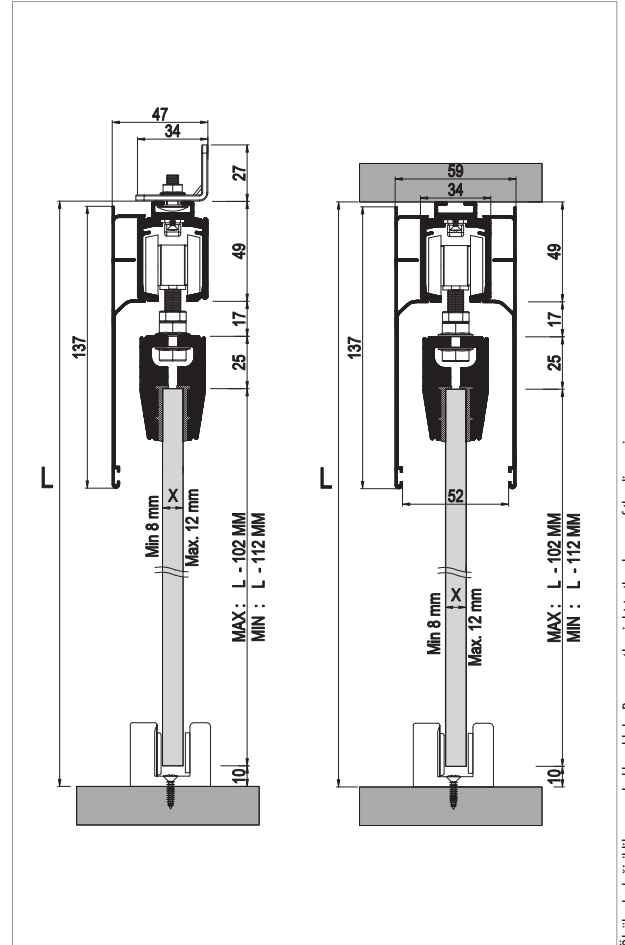

Ölçülerde değişiklik yapma hakkı saklıdır. Reserves the right to the change of the dimensions.

| Kod / Code No | Açıklama / Description | Renk / Colour | Birim / Unit | | | Profil mt. / Profiles mt. | Bağ / Bnd. |
|---------------|--|------------------------|----------------|----|-----|---------------------------|------------|
| 123-9920-1200 | 120 Kg Yavaşlatıcılı Sürgü Cam Kapı Sistemi / Sliding Glass Door System Has Soft Closing | Gri / Grey | 1 Kapı / 1 Kit | 12 | 216 | - | - |
| 150-9750-1400 | Alüminyum Üst Ray Profili / Aluminium Top Rail Profile | Pres / Uncoated | mt | - | - | 2,0 | 3,0 |
| 150-9765-1410 | Alüminyum Alın Kapama / Aluminium Cover Front | Eloksal / Mat Anodized | mt | - | - | 2,0 | 3,0 |

GlassDoor 9921

120 KG ÇİFT YÖNE YAVAŞLATICILI SÜRGÜ CAM KAPI SİSTEMİ • GLASS SLIDING DOOR SYSTEM TWO WAY SOFT CLOSING

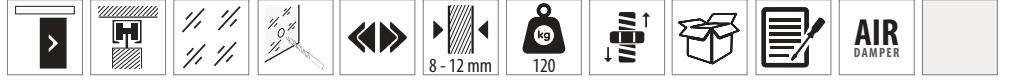

Bilgi / Information

- Minimum kapı genişliği 870 mm olmalıdır.
- Bu ürün camda delme işlemi gerektirmektedir.
- Min. Door width 870 mm
- This product need drilling on the glass.

Yavaşlatıcı Alternatifi / Soft Closer Alternative

- Sistem üzerinde çift yöne yavaşlatıcı mevcuttur.
- The system has two way soft closing.



123-9921 1 Takım İçeriği / 1 Kit Includes

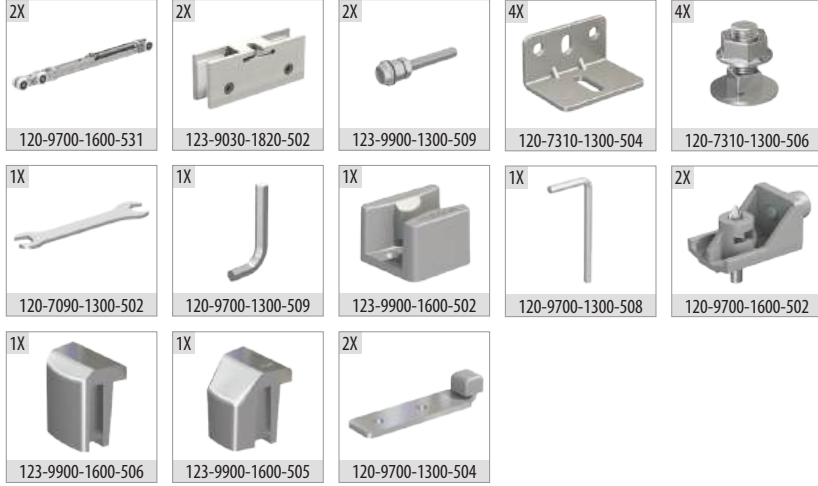

Ray Profilleri / Rail Profiles

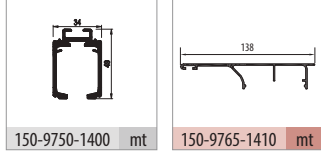

Uygulama / Application



Teknik Detay / Technical Detail

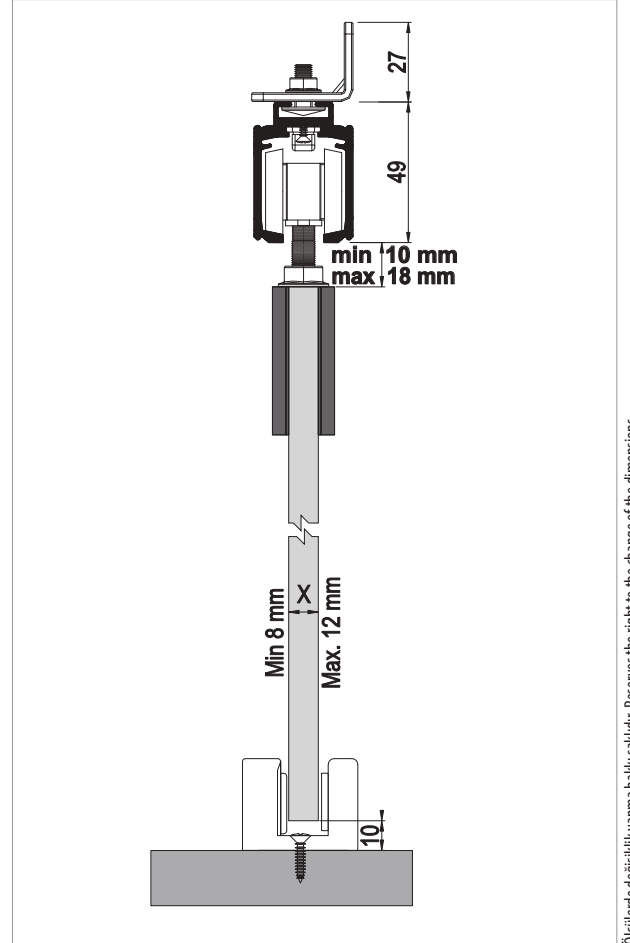

Ölçülerde değişiklik yapma hakkı saklıdır. Reserves the right to the change of the dimensions.

| Kod / Code No | Açıklama / Description | Renk / Colour | Birim / Unit | | | Profil mt. / Profiles mt. | | | Bağ / Bnd. |
|---------------|--|------------------------|----------------|----|-----|---------------------------|---|-----|------------|
| 123-9921-1820 | 120 Kg Yavaşlatıcılı Sürgü Cam Kapı Sistemi / Sliding Glass Door System Has Soft Closing | Gri / Grey | 1 Kapı / 1 Kit | 12 | 216 | - | - | - | - |
| 150-9750-1400 | Alüminyum Üst Ray Profili / Aluminium Top Rail Profile | Pres / Uncoated | mt | - | - | 2,0 | - | 3,0 | 2 ad/pcs |
| 150-9765-1410 | Alüminyum Alın Kapama / Aluminium Cover Front | Eloksal / Mat Anodized | mt | - | - | 2,0 | - | 3,0 | 2 ad/pcs |

Group 124

DoorSync[®] Glass

Cam Senkronize Sürme Kapı Serisi

Funicular Glass Door Series

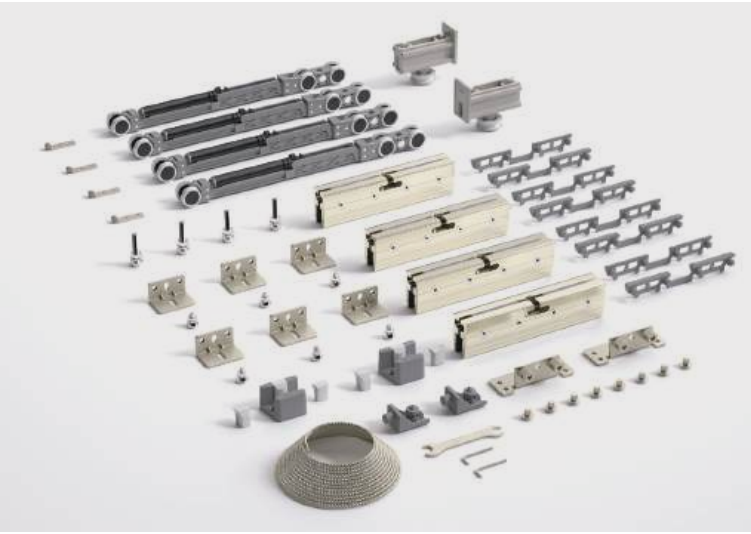

Bu serideki tüm ürünleri incelemek için QR kodu okutabilirsiniz.

You can search the QR code to see all the products in these series.

DoorSync Glass

CAM SENKRONİZE SÜRME KAPI SERİSİ • FUNICULAR GLASS DOOR SERIES

Group **124**



DoorSync **9935**

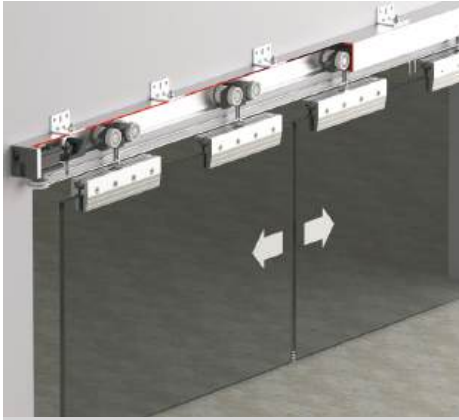

DoorSync **9940**

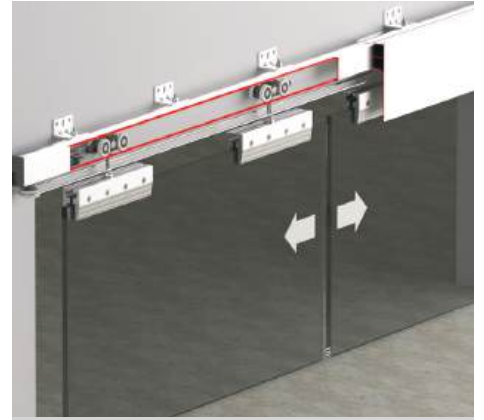

DoorSync **9950**

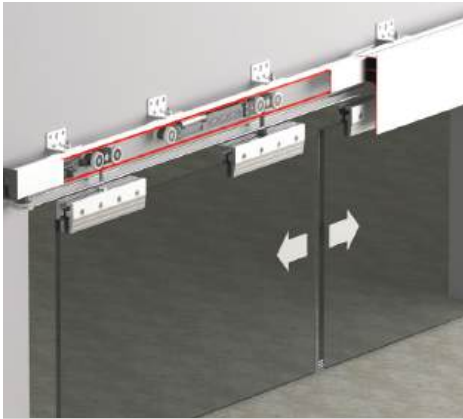

DoorSync **9951**

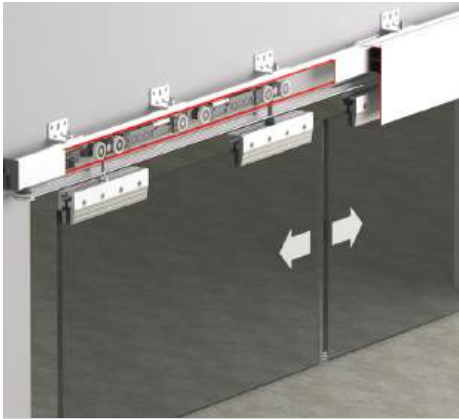

DoorSync **9960**

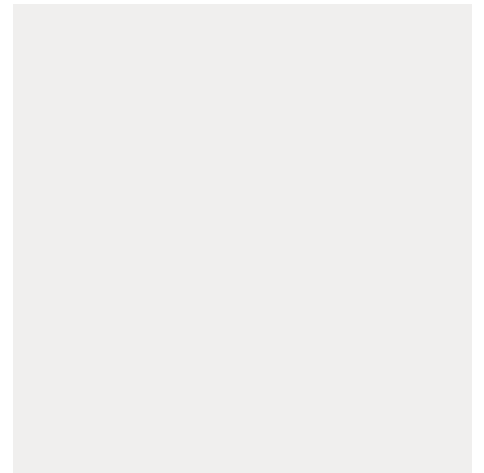
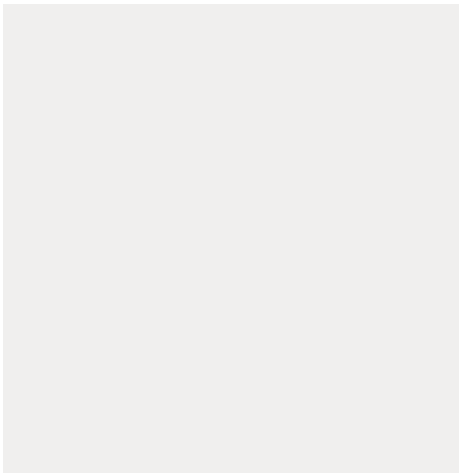
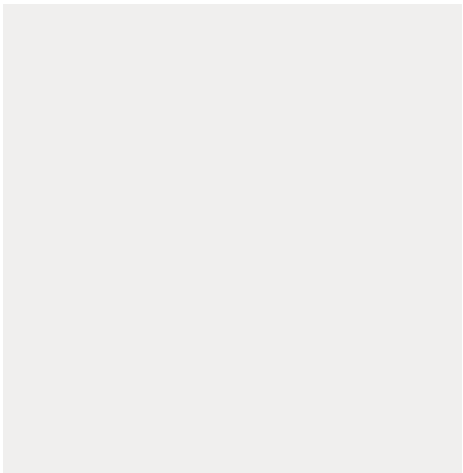
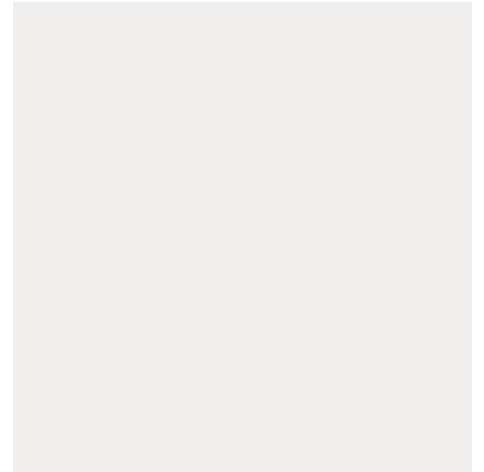
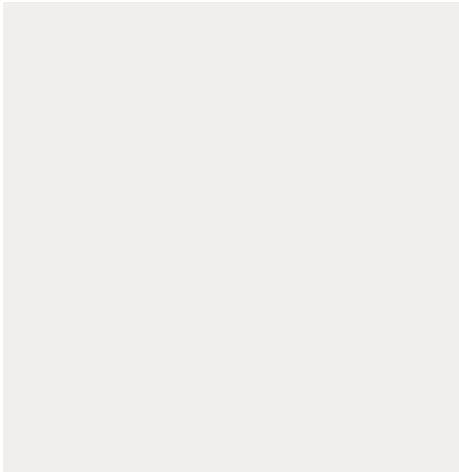
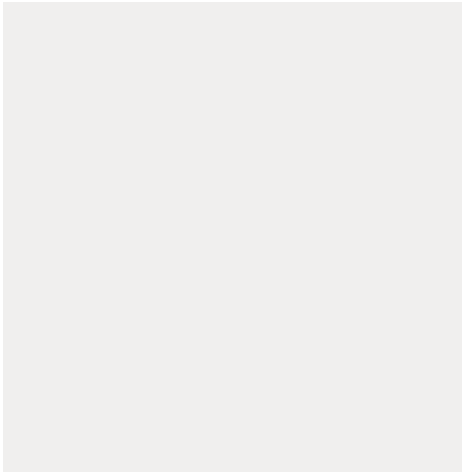
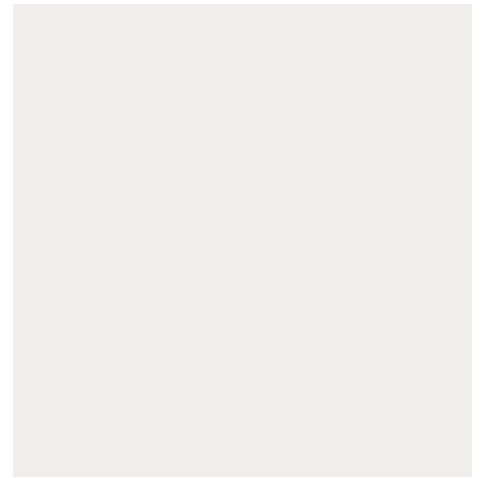

DoorSync 9935

40 KG ÇİFT YÖNE YAVAŞLATICILI HALATLI SÜRME CAM KAPI SİSTEMİ • FUNICULAR SLIDING GLASS DOOR SYSTEM

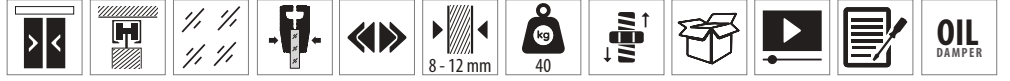

Bilgi / Information

- Minimum kapı genişliği 550 mm olmalıdır.
- Min. Door width 550 mm

Yavaşlatıcı Alternatifi / Soft Closer Alternative

- Sistem üzerinde çift yöne yavaşlatıcı mevcuttur.
- The system has two way soft closing.



124-9935 1 Takım İçeriği / 1 Kit Includes



Ray Profilleri / Rail Profiles

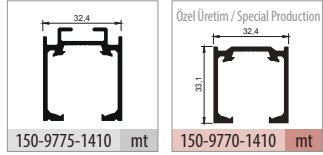

Uygulama / Application



Teknik Detay / Technical Detail

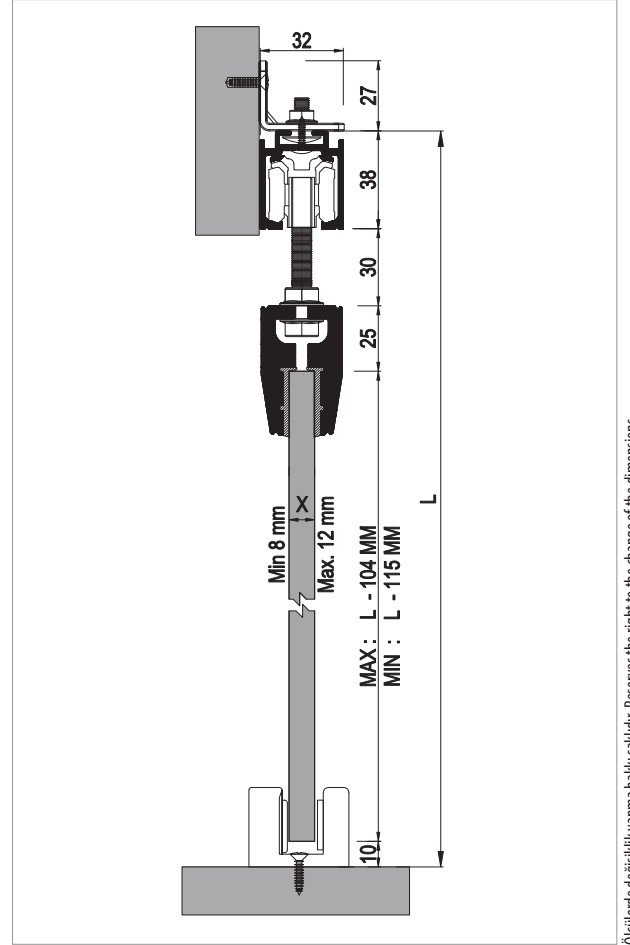

Ölçülerde değişiklik yapma hakkı saklıdır. Reserves the right to the change of the dimensions.







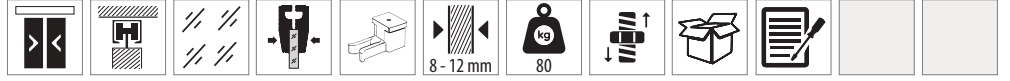











| Kod / Code No | Açıklama / Description | Renk / Colour | Birim / Unit | | | Profil mt. / Profiles mt. | Bağ / Bnd. |
|---------------|---|------------------------|----------------|---|-----|---------------------------|------------|
| 124-9935-1200 | 60 Kg Yavaşlatıcılı Sürgü Cam Kapı Sistemi / Sliding Glass Door System Has Soft Closing | Gri / Grey | 2 Kapı / 1 Set | 1 | 100 | - | - |
| 150-9775-1410 | Alüminyum Üst Ray Profili / Aluminium Top Rail Profile | Eloksal / Mat Anodized | mt. | - | - | - | 6,0 |

DoorSync 9940

80 KG HALATLI SÜRGÜ CAM KAPI SİSTEMİ • FUNICULAR SLIDING GLASS DOOR SYSTEM



124-9940 1 Set İçeriği / 1 Set Includes

| | | | | |
|---|--|--|---|---|
| 4X  120-7380-1600-530 | 4X  123-9900-1200-508 | 4X  123-9900-1300-509 | 2X  123-9900-1600-502 | 2X  120-7380-1600-501 |
| 1X  120-7090-1300-502 | 1X 10 mt.  121-9800-1300-510 | 2X  121-9810-1600-500 | 2X  121-9800-1300-505 | 2X  123-9900-1600-506 |
| 4X  123-9900-1600-503 | 4X  123-9900-1600-504 | 2X  123-9900-1600-505 | 6X  120-7310-1300-506 | 6X  120-7310-1300-504 |
| 1X  120-9700-1300-509 | 1X  120-9700-1300-508 | 8X  124-9940-1300-502 | | |

Ray Profilleri / Rail Profiles

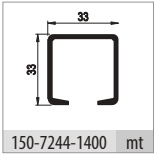



Uygulama / Application

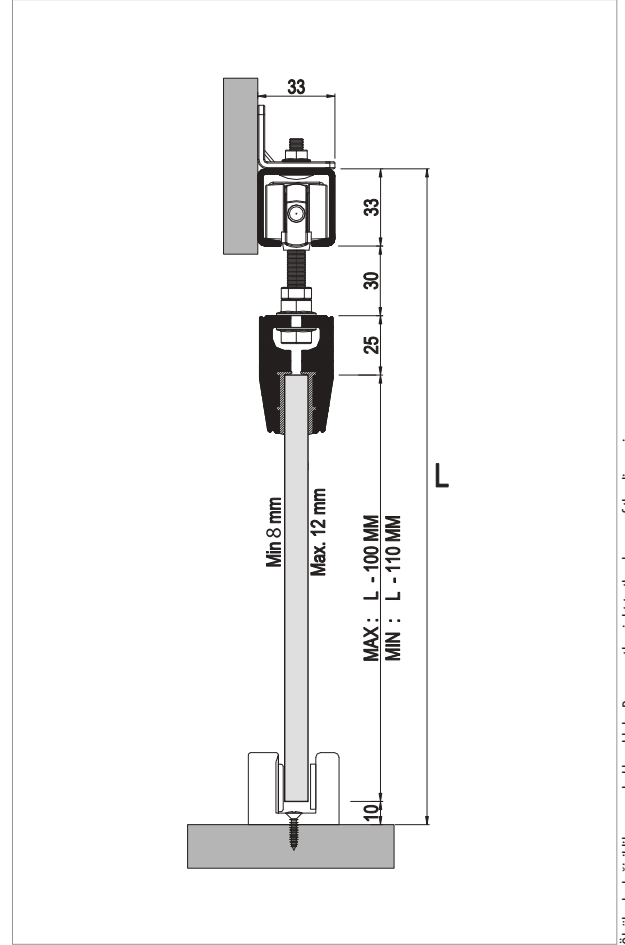

Teknik Detay / Technical Detail



Ölçülerde değişiklik yapma hakkı saklıdır. Reserves the right to the change of the dimensions.

| Kod / Code No | Açıklama / Description | Renk / Colour | Birim / Unit |  |  | Profil mt. / Profiles mt. | | | Bağ / Bnd. |
|---------------|---|-----------------|----------------|---|---|---------------------------|-----|-----|------------|
| 124-9940-1200 | 80 Kg Senkronize Cam Kapi Sistemi / Funicular Glass Door System | Gri / Grey | 2 Kapi / 1 Set | 1 | 100 | - | - | - | - |
| 150-7244-1400 | Alüminyum Üst Ray Profili / Aluminium Top Rail Profile | Pres / Uncoated | mt | - | - | 3,0 | 4,0 | 6,0 | 6 ad/pcs |

DoorSync 9950

120 KG HALATLI SÜRGÜ CAM KAPI SİSTEMİ • FUNICULAR SLIDING GLASS DOOR SYSTEM

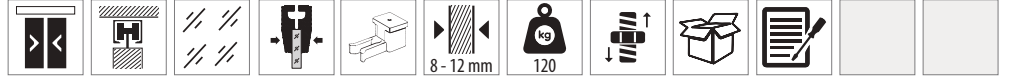

Bilgi / Information

- Minimum kapı genişliği 400 mm olmalıdır.
- Min. Door width 400 mm



124-9950 1 Set İçeriği / 1 Set Includes



Ray Profilleri / Rail Profiles

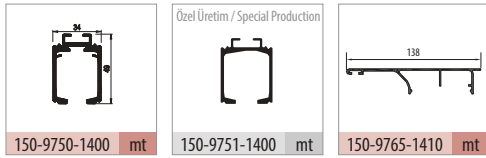

Uygulama / Application



Teknik Detay / Technical Detail

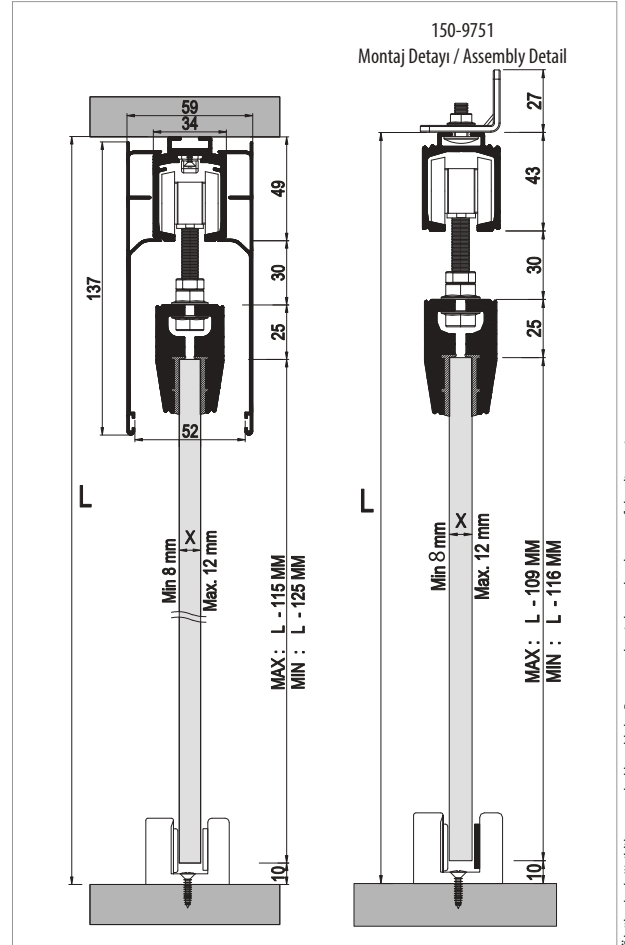

Ölçülerde değişiklik yapma hakkı saklıdır. Reserves the right to the change of the dimensions.

| Kod / Code No | Açıklama / Description | Renk / Colour | Birim / Unit | | | Profil mt. / Profiles mt. | Bağ / Bnd. | | |
|---------------|--|------------------------|----------------|---|-----|---------------------------|------------|-----|----------|
| 124-9950-1200 | 120 Kg Senkronize Cam Kapı Sistemi / Funicular Glass Door System | Gri / Grey | 2 Kapı / 1 Set | 1 | 100 | - | - | - | |
| 150-9750-1400 | Alüminyum Üst Ray Profili / Aluminium Top Rail Profile | Pres / Uncoated | mt | - | - | 3,0 | 4,0 | 6,0 | 2 ad/pcs |
| 150-9751-1400 | Alüminyum Üst Ray Profili / Aluminium Top Rail Profile | Pres / Uncoated | mt | - | - | 3,0 | 4,0 | 6,0 | 2 ad/pcs |
| 150-9765-1410 | Alüminyum Alın Kapama / Aluminium Cover Front | Eloksal / Mat Anodized | mt | - | - | 3,0 | 4,0 | 6,0 | 2 ad/pcs |

DoorSync 9951

120 KG HALATLI TEK YÖNE YAVAŞLATICILI SÜRGÜ CAM KAPI SİSTEMİ • FUNICULAR SLIDING GLASS DOOR SYSTEM

9950 SFT

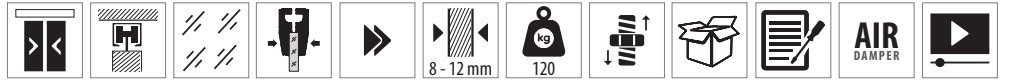

Bilgi / Information

- Minimum kapı genişliği 600 mm olmalıdır.
- Min. Door width 600 mm

Yavaşlatıcı Alternatifi / Soft Closer Alternative

- Sistem üzerinde tek yöne yavaşlatıcı mevcuttur.
- The system has one way soft closing.



124-9951 1 Set İçeriği / 1 Set Includes



Ray Profilleri / Rail Profiles

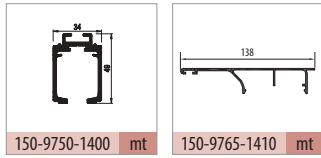

Uygulama / Application



Teknik Detay / Technical Detail

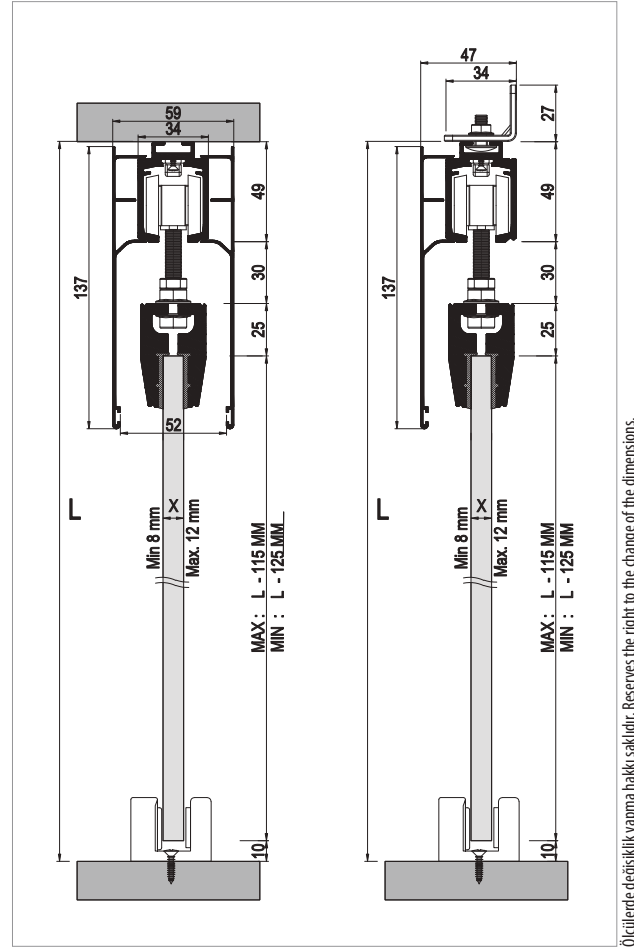

Ölçülerde değişiklik yapma hakkı saklıdır. Reserves the right to the change of the dimensions.

| Kod / Code No | Açıklama / Description | Renk / Colour | Birim / Unit | | | Profil mt. / Profiles mt. | | | Bağ / Bnd. |
|---------------|--|------------------------|----------------|---|-----|---------------------------|-----|-----|------------|
| 124-9951-1200 | 120 Kg Yavaşlatıcılı Senkronize Cam Kapi Sistemi / Funicular Glass Door System | Gri / Grey | 2 Kapı / 1 Set | 1 | 100 | - | - | - | - |
| 150-9750-1400 | Alüminyum Üst Ray Profili / Aluminium Top Rail Profile | Pres / Uncoated | mt | - | - | 3,0 | 4,0 | 6,0 | 2 ad/pcs |
| 150-9765-1410 | Alüminyum Alın Kapama / Aluminium Cover Front | Eloksal / Mat Anodized | mt | - | - | 3,0 | 4,0 | 6,0 | 2 ad/pcs |

DoorSync 9960

120 KG ÇİFT YÖNE YAVAŞLATICILI HALATLI SÜRGÜ CAM KAPI SİSTEMİ • FUNICULAR SLIDING GLASS DOOR SYSTEM - HAS SOFT CLOSING

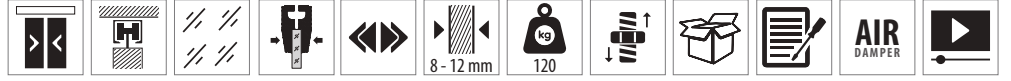

Bilgi / Information

- Minimum kapı genişliği 900 mm olmalıdır.
- Min. Door width 900 mm

Yavaşlatıcı Alternatifi / Soft Closer Alternative

- Sistem üzerinde çift yöne yavaşlatıcı mevcuttur.
- The system has two way soft closing.



124-9960 1 Set İçeriği / 1 Set Includes



Ray Profilleri / Rail Profiles

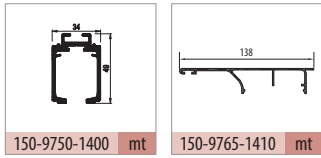

Uygulama / Application



Teknik Detay / Technical Detail

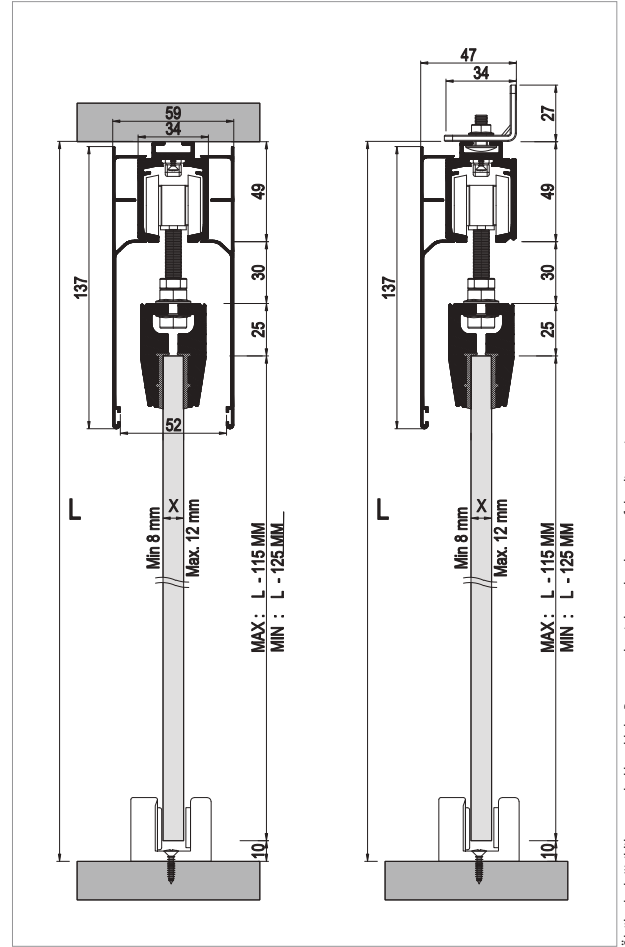

Ölçülerde değişiklik yapma hakkı saklıdır. Reserves the right to the change of the dimensions.

| Kod / Code No | Açıklama / Description | Renk / Colour | Birim / Unit | | | Profil mt. / Profiles mt. | | | Bağ / Bnd. |
|---------------|--|------------------------|----------------|---|-----|---------------------------|-----|-----|------------|
| 124-9960-1200 | 120 Kg Yavaşlatıcılı Senkronize Cam Kapi Sistemi / Funicular Glass Door System | Gri / Grey | 2 Kapı / 1 Set | 1 | 100 | - | - | - | - |
| 150-9750-1400 | Alüminyum Üst Ray Profili / Aluminium Top Rail Profile | Pres / Uncoated | mt | - | - | 3,0 | 4,0 | 6,0 | 2 ad/pcs |
| 150-9765-1410 | Alüminyum Alın Kapama / Aluminium Cover Front | Eloksal / Mat Anodized | mt | - | - | 3,0 | 4,0 | 6,0 | 2 ad/pcs |

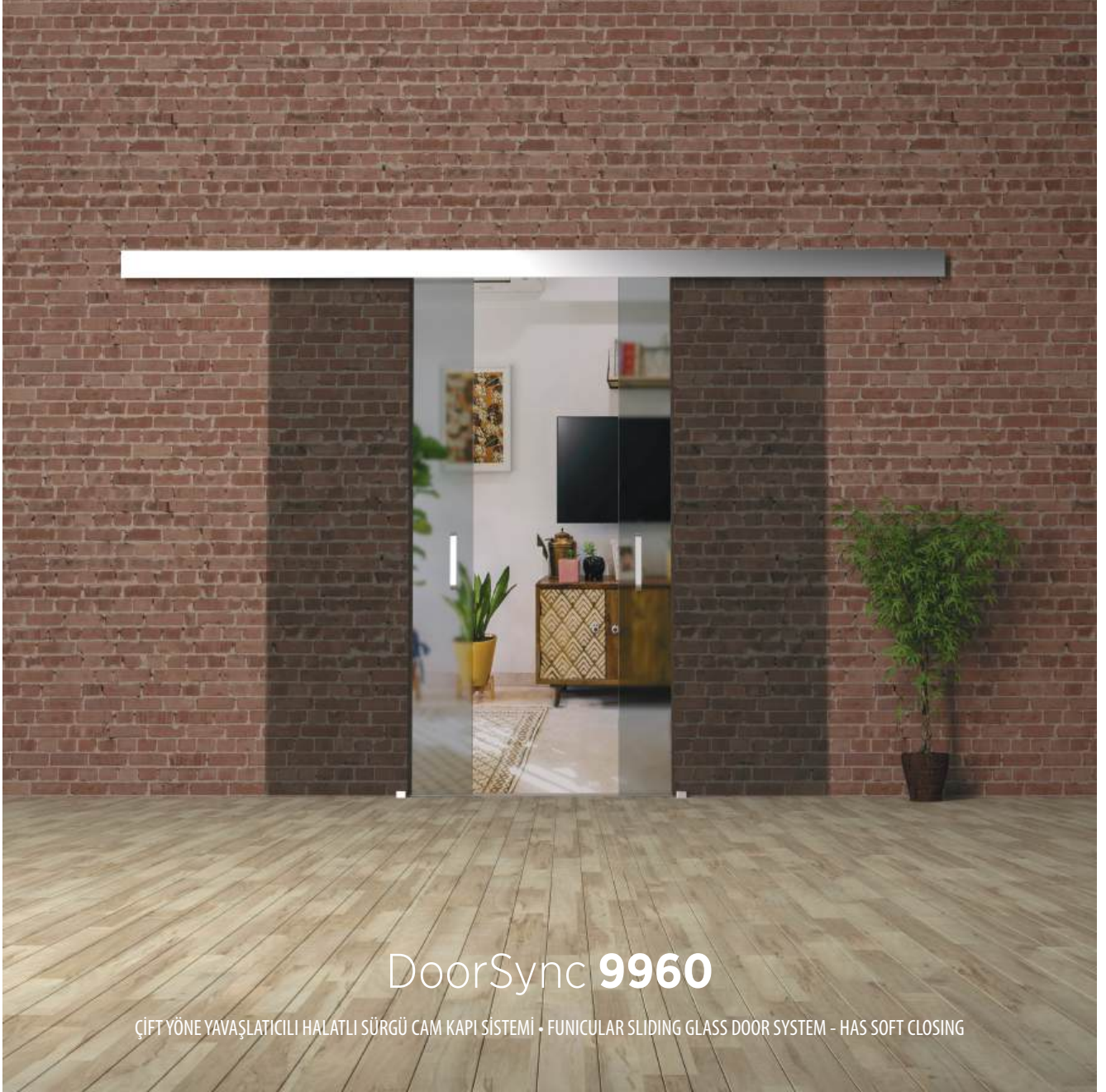

DoorSync 9960

ÇİFT YÖNE YAVAŞLATICILI HALATLI SÜRGÜ CAM KAPI SİSTEMİ • FUNICULAR SLIDING GLASS DOOR SYSTEM - HAS SOFT CLOSING

albaturas.com

Group 127

MultiDoor[®]

Teleskopik Ahşap Sürme Kapı Serisi

Telescopic Wooden Sliding Door Series



Bu serideki tüm ürünleri incelemek için QR kodu okutabilirsiniz.

You can search the QR code to see all the products in these series.

MultiDoor

TELESKOPIK AHŞAP SÜRME KAPI SİSTEMLERİ • TELESCOPIC WOODEN SLIDING DOOR SYSTEMS

Group 127



MultiDoor 100



MultiDoor 150



MultiDoor 200



MultiDoor 250



MultiDoor 260



MultiDoor 400



MultiDoor 450

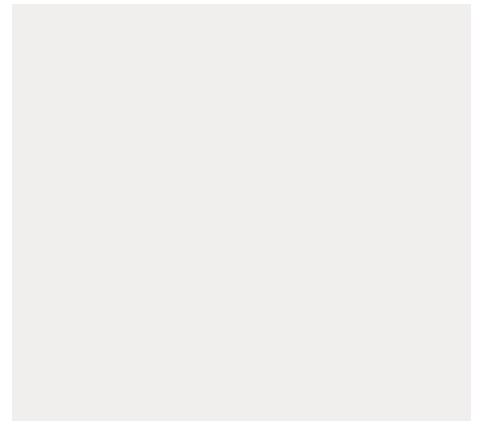
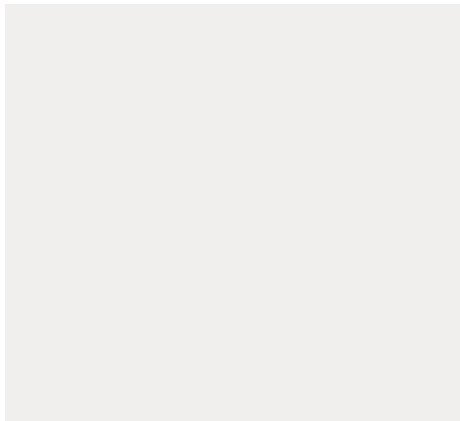
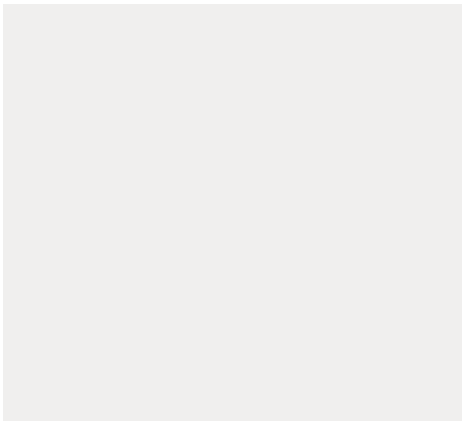
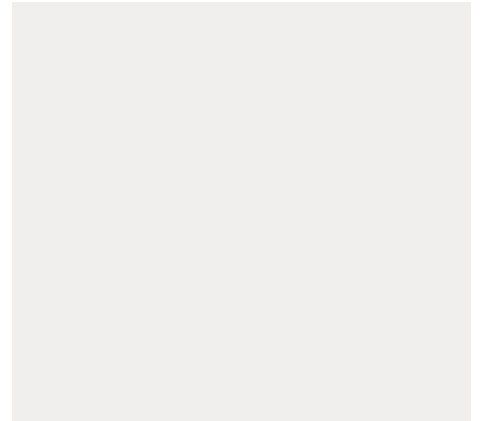
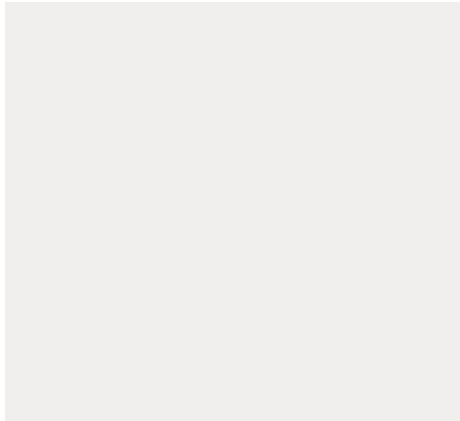

MultiDoor 100

80 KG TELESKOPIK SÜRME KAPI SİSTEMİ • TELESCOPIC SLIDING DOOR SYSTEMS

Yeni Ürün
New Product

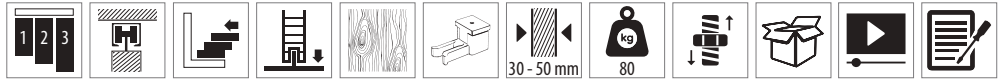

Bilgi / Information

- Minimum kapı genişliği 400 mm olmalıdır.
- Min. Door width 400 mm



127-0102 1 Set İçeriği / 1 Set Includes

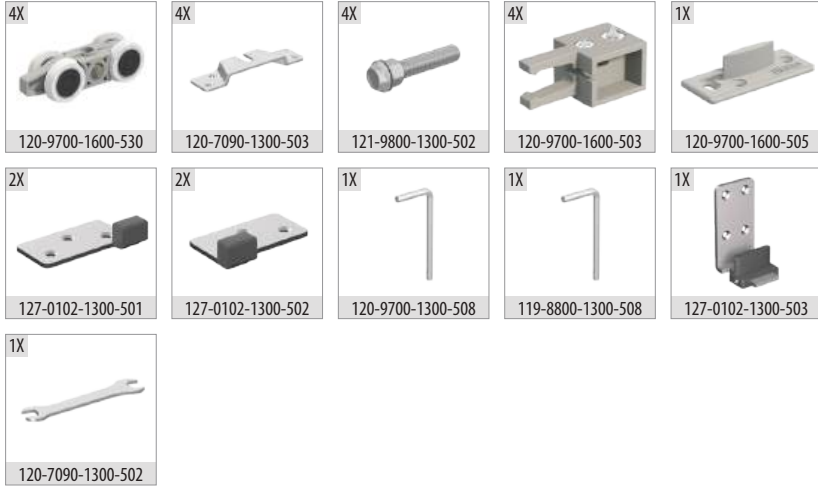

127-0101 1 Takım İçeriği (Opsiyonel Ek Kapı) / 1 Kit Includes (Optional Additional Door)



Ray Profilleri / Rail Profiles

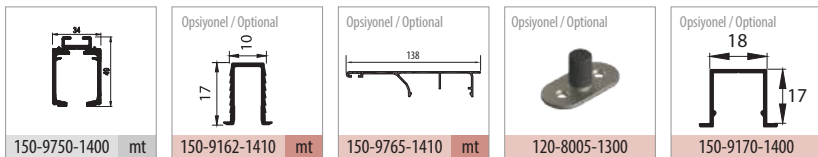

Teknik Detay / Technical Detail

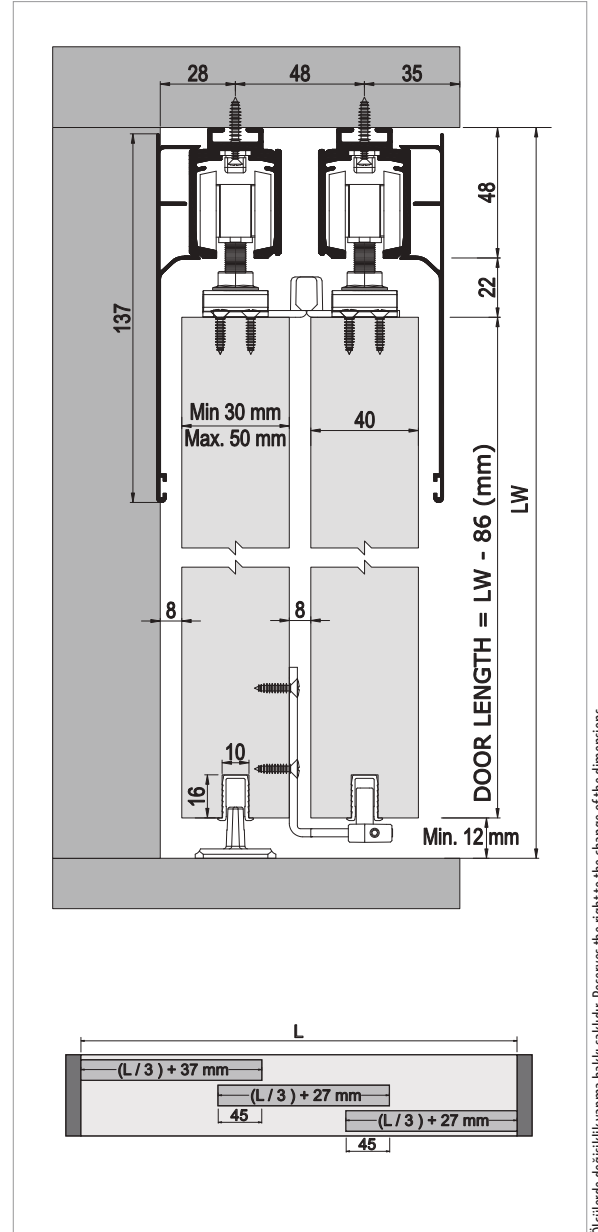

Ölçülerde değişiklik yapma hakkı saklıdır. Reserves the right to the change of the dimensions.

| Kod / Code No | Açıklama / Description | Renk / Colour | Birim / Unit | | | Profil mt. / Profiles mt. | Bağ / Bnd. |
|---------------|--|------------------------|----------------|----|-----|---------------------------|--------------|
| 127-0102-1600 | MultiDoor 102 Teleskopik Sürme Kapı Sistemi / Telescopic Sliding Door System | Gri / Grey | 2 Kapı / 1 Set | 16 | 512 | - - - | - |
| 127-0101-1600 | MultiDoor 101 İlave Kapı Sistemi / Additional Door System | Gri / Grey | 1 Kapı / 1 Kit | 24 | 576 | - - - | - |
| 150-9750-1400 | Alüminyum Üst Ray Profili / Aluminium Top Rail Profile | Pres / Uncoated | mt. | - | - | - - | 6,0 2 ad/pcs |
| 150-9162-1410 | Alüminyum Alt Klavuz Profili / Aluminium Bottom Slider Profile | Eloksal / Mat Anodized | mt. | - | - | - 3,0 6,0 | 20 ad/pcs |
| 150-9765-1410 | Alüminyum Alın Kapama / Aluminium Cover Front | Eloksal / Mat Anodized | mt. | - | - | 2,0 3,0 6,0 | 2 ad/pcs |

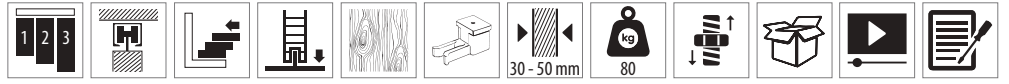

Bilgi / Information

- Minimum kapı genişliği 450 mm olmalıdır.
- Min. Door width 450 mm



127-0152 1 Set İçeriği / 1 Set Includes



127-0151 1 Takım İçeriği (Opsiyonel Ek Kapı) / 1 Kit Includes (Optional Additional Door)



Ray Profilleri / Rail Profiles

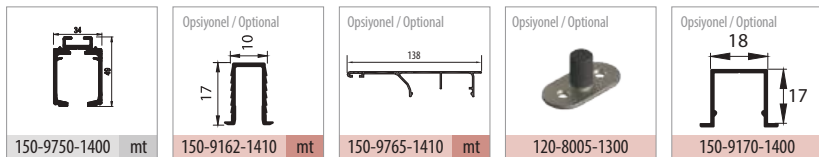

Teknik Detay / Technical Detail

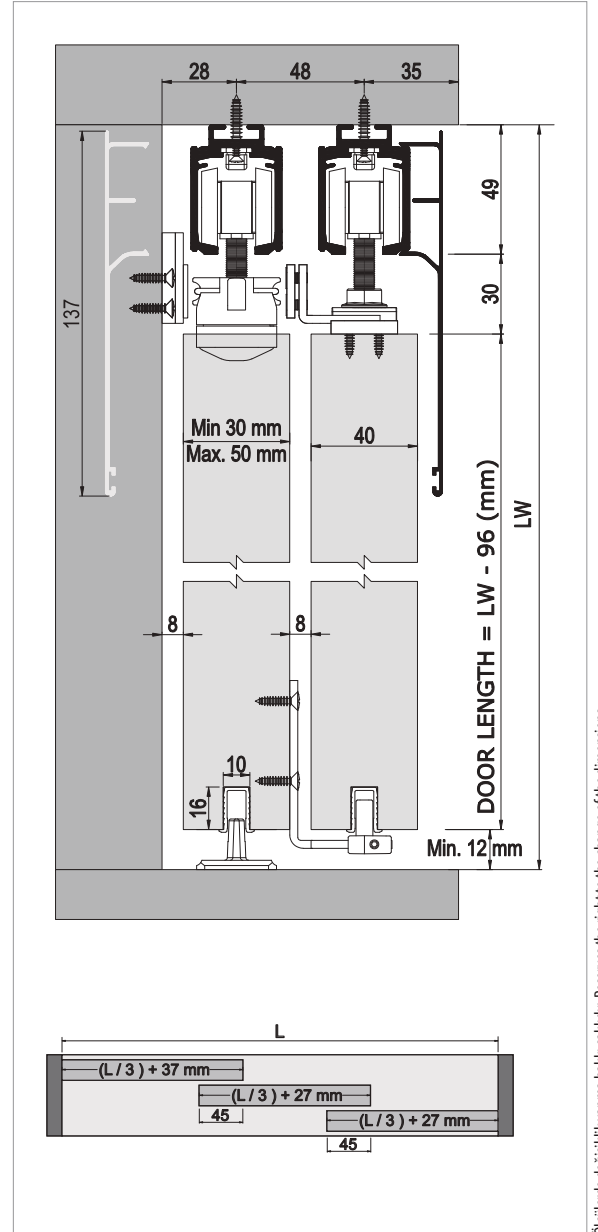

Özelliklerde değişiklik yapma hakkı saklıdır. Reserves the right to the change of the dimensions.

| Kod / Code No | Açıklama / Description | Renk / Colour | Birim / Unit | | | Profil mt. / Profiles mt. | Bağ / Bnd. |
|-------------------|--|------------------------|----------------|----|-----|---------------------------|--------------|
| 127-0152-1600 | MultiDoor 152 Teleskopik Sürme Kapı Sistemi / Telescopic Sliding Door System | Gri / Grey | 2 Kapı / 1 Set | 12 | 360 | - - - | - |
| 127-0151-1600 | MultiDoor 151 İlave Kapı Sistemi / Additional Door System | Gri / Grey | 1 Kapı / 1 Kit | 16 | 512 | - - - | - |
| 127-0152-1300-510 | İlave Çelik Halat / Additional Wire Rope | Gri / Grey | mt. | - | - | - - - | - |
| 150-9750-1400 | Alüminyum Üst Ray Profili / Aluminium Top Rail Profile | Pres / Uncoated | mt. | - | - | - - | 6,0 2 ad/pcs |
| 150-9162-1410 | Alüminyum Alt Klavuz Profili / Aluminium Bottom Slider Profile | Eloksal / Mat Anodized | mt. | - | - | - 3,0 6,0 | 20 ad/pcs |
| 150-9765-1410 | Alüminyum Alın Kapama / Aluminium Cover Front | Eloksal / Mat Anodized | mt. | - | - | 2,0 3,0 6,0 | 2 ad/pcs |



Bilgi / Information

- Minimum kapı genişliği 620 mm olmalıdır.
- Min. Door width 620 mm

Yavaşlatıcı Alternatifi / Soft Closer Alternative

- Sistem üzerinde tek yöne yavaşlatıcı mevcuttur.
- The system has one way soft closing.



127-0202 1 Set İçeriği / 1 Set Includes



127-0201 1 Takım İçeriği (Opsiyonel Ek Kapı) / 1 Kit Includes (Optional Additional Door)



Ray Profilleri / Rail Profiles

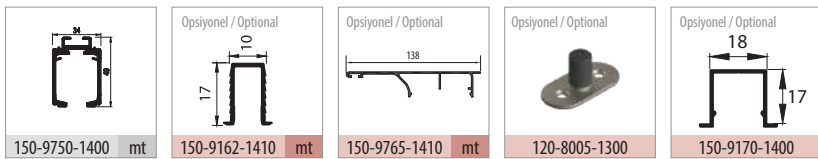

Teknik Detay / Technical Detail

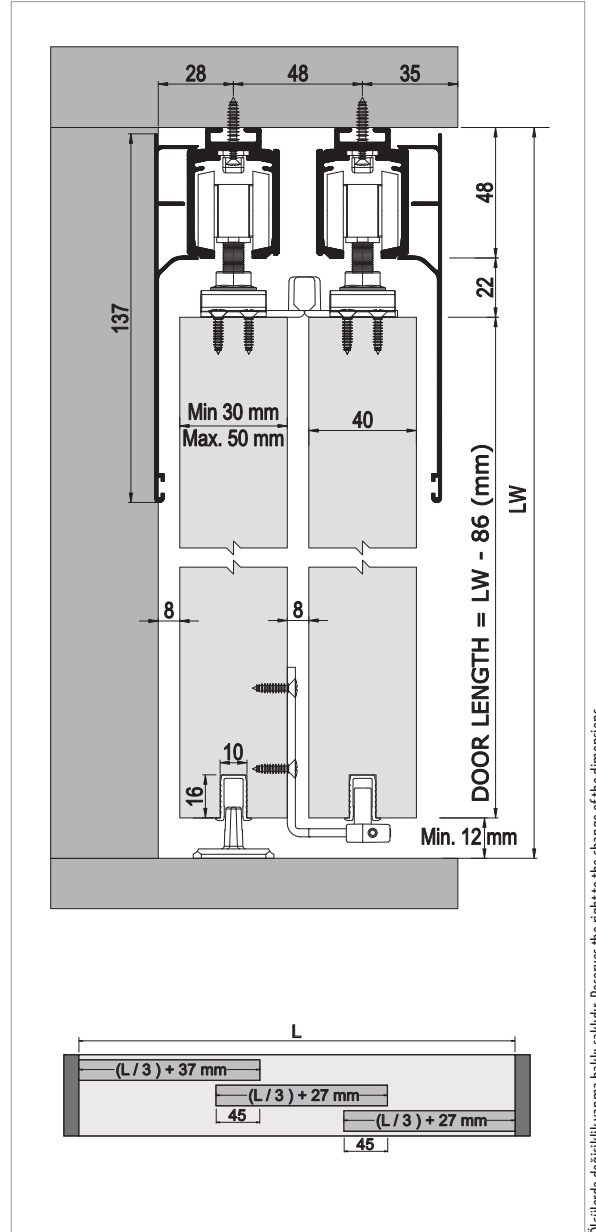

Ölçülerde değişiklik yapma hakkı saklıdır. Reserves the right to the change of the dimensions.

| Kod / Code No | Açıklama / Description | Renk / Colour | Birim / Unit | | | Profil mt. / Profiles mt. | Bağ / Bnd. |
|---------------|--|------------------------|----------------|----|-----|---------------------------|------------|
| 127-0202-1600 | MultiDoor 202 Teleskopik Sürme Kapı Sistemi / Telescopic Sliding Door System | Gri / Grey | 2 Kapı / 1 Set | 12 | 216 | - - - | - |
| 127-0201-1600 | MultiDoor 201 İlave Kapı Sistemi / Additional Door System | Gri / Grey | 1 Kapı / 1 Kit | 8 | 400 | - - - | - |
| 150-9750-1400 | Alüminyum Üst Ray Profili / Aluminium Top Rail Profile | Pres / Uncoated | mt. | - | - | 2,0 3,0 6,0 | 2 ad/pcs |
| 150-9162-1410 | Alüminyum Alt Klavuz Profili / Aluminium Bottom Slider Profile | Eloksal / Mat Anodized | mt. | - | - | - 3,0 6,0 | 20 ad/pcs |
| 150-9765-1410 | Alüminyum Alın Kapama / Aluminium Cover Front | Eloksal / Mat Anodized | mt. | - | - | 2,0 3,0 6,0 | 2 ad/pcs |

MultiDoor 250

80 KG TEK YÖNE YAVAŞLATICILI HALATLI TELESKOPİK SÜRME KAPI SİSTEMİ - SOFTLINE TELESCOPIC SLIDING DOOR SYSTEMS

Yeni Ürün
New Product



Bilgi / Information

- Minimum kapı genişliği 670 mm olmalıdır.
- Min. Door width 670 mm

Yavaşlatıcı Alternatifi / Soft Closer Alternative

- Sistem üzerinde tek yöne yavaşlatıcı mevcuttur.
- The system has one way soft closing.



127-0252 1 Set İçeriği / 1 Set Includes



127-0251 1 Takım İçeriği (Opsiyonel Ek Kapı) / 1 Kit Includes (Optional Additional Door)



Ray Profilleri / Rail Profiles

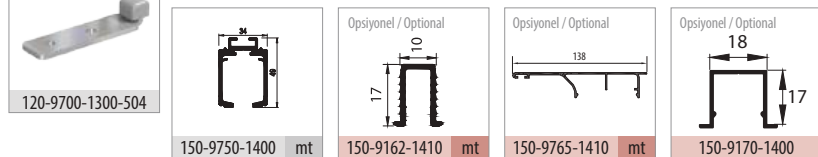

Teknik Detay / Technical Detail

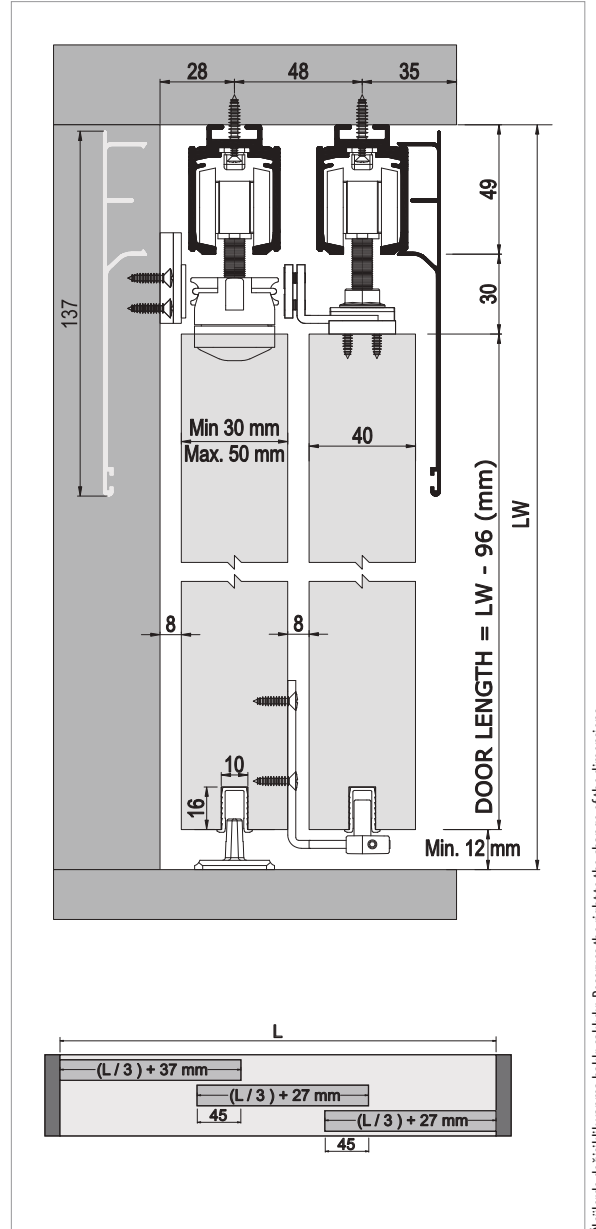

Ölçülerde değişiklik yapma hakkı saklıdır. Reserves the right to the change of the dimensions.

| Kod / Code No | Açıklama / Description | Renk / Colour | Birim / Unit | | | Profil mt. / Profiles mt. | Bağ / Bnd. |
|-------------------|--|------------------------|----------------|----|-----|---------------------------|------------|
| 127-0252-1600 | MultiDoor 252 Teleskopik Sürme Kapı Sistemi / Telescopic Sliding Door System | Gri / Grey | 2 Kapı / 1 Set | 12 | 216 | - | - |
| 127-0251-1600 | MultiDoor 251 İlave Kapı Sistemi / Additional Door System | Gri / Grey | 1 Kapı / 1 Kit | 8 | 400 | - | - |
| 127-0152-1300-510 | İlave Çelik Halat / Additional Wire Rope | Gri / Grey | mt. | - | - | - | - |
| 150-9750-1400 | Alüminyum Üst Ray Profili / Aluminium Top Rail Profile | Pres / Uncoated | mt. | - | - | 2,0 3,0 6,0 | 2 ad/pcs |
| 150-9162-1410 | Alüminyum Alt Klavuz Profili / Aluminium Bottom Slider Profile | Eloksal / Mat Anodized | mt. | - | - | - 3,0 6,0 | 20 ad/pcs |
| 150-9765-1410 | Alüminyum Alın Kapama / Aluminium Cover Front | Eloksal / Mat Anodized | mt. | - | - | 2,0 3,0 6,0 | 2 ad/pcs |

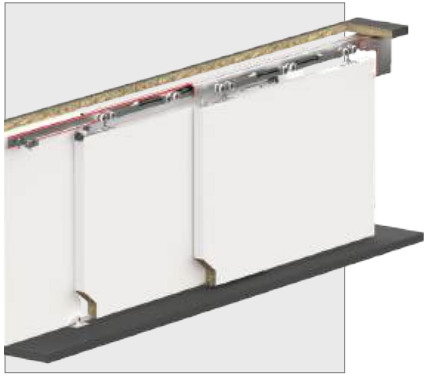

Bilgi / Information

- Minimum kapı genişliği 976 mm olmalıdır.
- Min. Door width 976 mm

Yavaşlatıcı Alternatifi / Soft Closer Alternative

- Sistem üzerinde çift yöne yavaşlatıcı mevcuttur.
- The system has two way soft closing.



127-0262 1 Set İçeriği / 1 Set Includes



127-0261 1 Takım İçeriği (Opsiyonel Ek Kapı) / 1 Kit Includes (Optional Additional Door)



Ray Profilleri / Rail Profiles

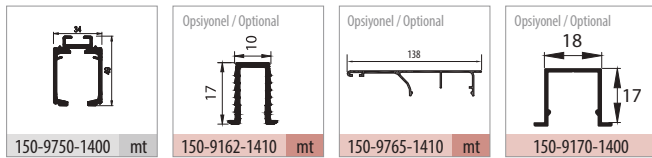

Teknik Detay / Technical Detail

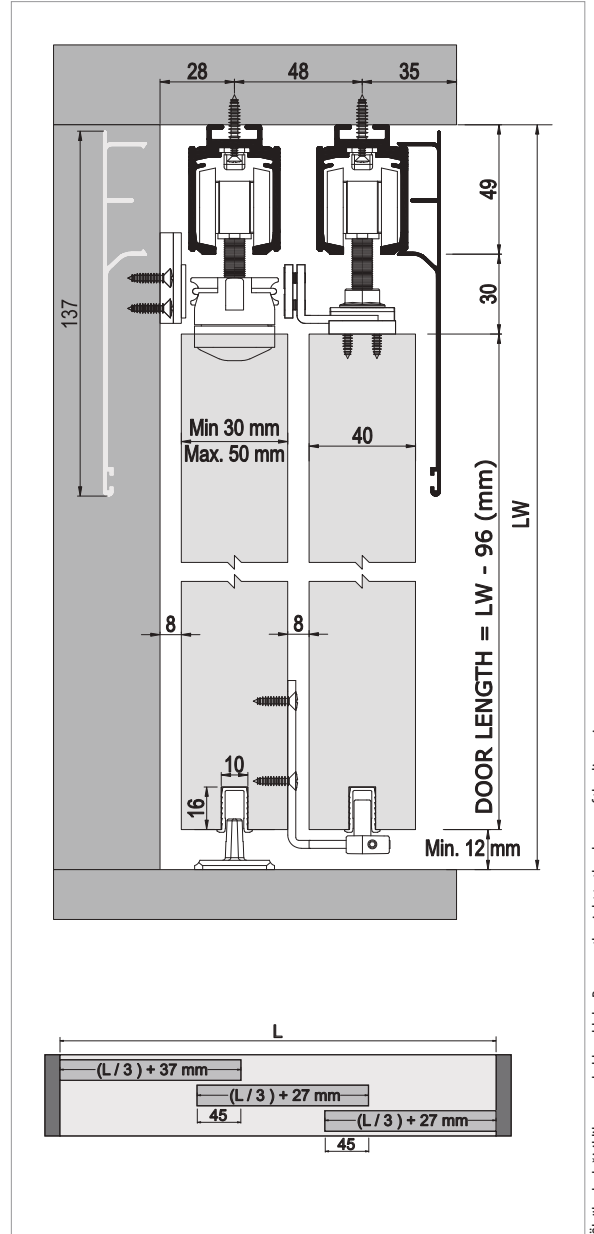

Ölçülerde değişiklik yapma hakkı saklıdır. Reserves the right to the change of the dimensions.

| Kod / Code No | Açıklama / Description | Renk / Colour | Birim / Unit | | | Profil mt. / Profiles mt. | Bağ / Bnd. |
|-------------------|--|------------------------|----------------|----|-----|---------------------------|------------|
| 127-0262-1600 | MultiDoor 262 Teleskopik Sürme Kapı Sistemi / Telescopic Sliding Door System | Gri / Grey | 2 Kapı / 1 Set | 12 | 216 | - | - |
| 127-0261-1600 | MultiDoor 261 İlave Kapı Sistemi / Additional Door System | Gri / Grey | 1 Kapı / 1 Kit | 8 | 400 | - | - |
| 127-0152-1300-510 | İlave Çelik Halat / Additional Wire Rope | Gri / Grey | mt. | - | - | - | - |
| 150-9750-1400 | Alüminyum Üst Ray Profili / Aluminium Top Rail Profile | Pres / Uncoated | mt. | - | - | 2,0 3,0 6,0 | 2 ad/pcs |
| 150-9162-1410 | Alüminyum Alt Klavuz Profili / Aluminium Bottom Slider Profile | Eloksal / Mat Anodized | mt. | - | - | - 3,0 6,0 | 20 ad/pcs |
| 150-9765-1410 | Alüminyum Alın Kapama / Aluminium Cover Front | Eloksal / Mat Anodized | mt. | - | - | 2,0 3,0 6,0 | 2 ad/pcs |



MultiDoor 250

80 KG TEK YÖNE YAVAŞLATICILI HALATLI TELESKOPİK SÜRME KAPI SİSTEMİ • SOFTLINE TELESCOPIC SLIDING DOOR SYSTEMS

albaturas.com

MultiDoor 400

60 KG ÇİFT YÖNE YAVAŞLATICILI TELESKOPİK SÜRME KAPI SİSTEMİ • SOFTLINE TELESCOPIC SLIDING DOOR SYSTEMS

Yeni Ürün
New Product



Bilgi / Information

- Minimum kapı genişliği 770 mm olmalıdır.
- Min. Door width 770 mm

Yavaşlatıcı Alternatifi / Soft Closer Alternative

- Sistem üzerinde çift yöne yavaşlatıcı mevcuttur.
- The system has two way soft closing.



127-0402 1 Set İçeriği / 1 Set Includes



127-0401 1 Takım İçeriği (Opsiyonel Ek Kapı) / 1 Kit Includes (Optional Additional Door)



Ray Profilleri / Rail Profiles

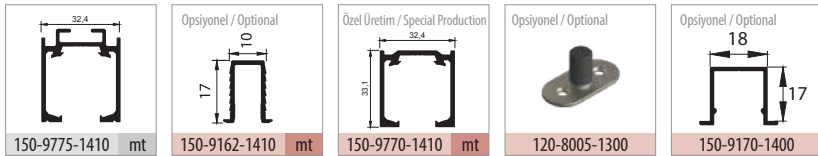

Teknik Detay / Technical Detail

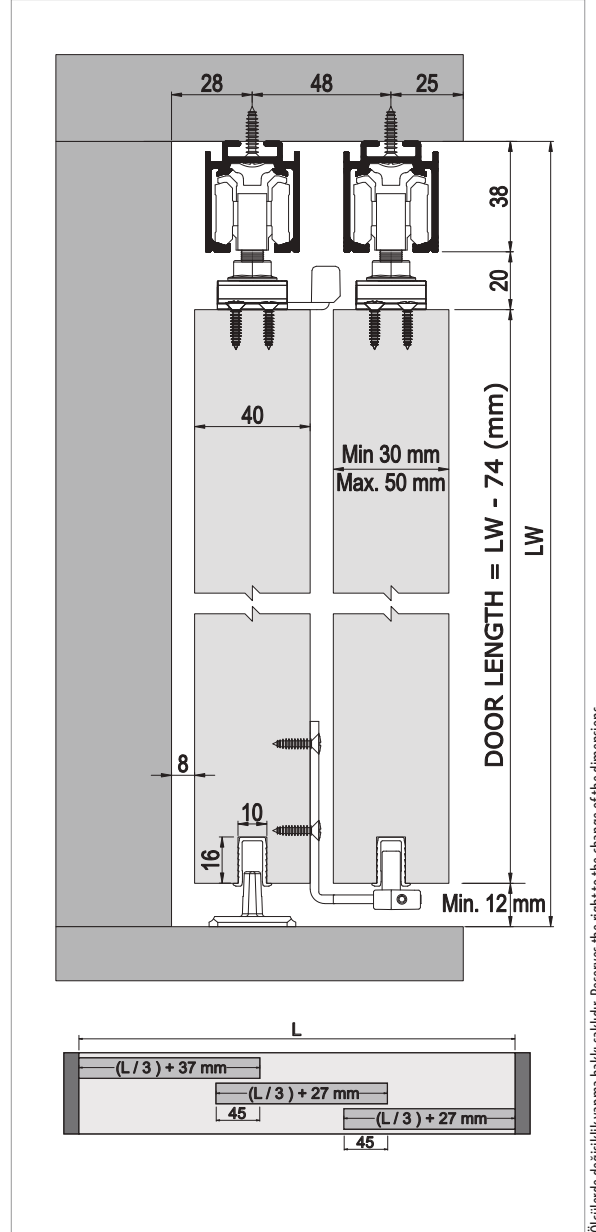

Ölçülerde değişiklik yapma hakkı saklıdır. Reserves the right to the change of the dimensions.

| Kod / Code No | Açıklama / Description | Renk / Colour | Birim / Unit | | | Profil mt. / Profiles mt. | Bağ / Bnd. |
|---------------|--|------------------------|----------------|---|-----|---------------------------|------------|
| 127-0402-1410 | MultiDoor 402 Teleskopik Sürme Kapı Sistemi / Telescopic Sliding Door System | Gri / Grey | 2 Kapı / 1 Set | 4 | 144 | - - - | - |
| 127-0401-1410 | MultiDoor 401 İlave Kapı Sistemi / Additional Door System | Gri / Grey | 1 Kapı / 1 Kit | 4 | 144 | - - - | - |
| 150-9775-1410 | Alüminyum Üst Ray Profili / Aluminium Top Rail Profile | Eloksal / Mat Anodized | mt. | - | - | 3,0 4,0 6,0 | 6 ad/pcs |
| 150-9162-1410 | Alüminyum Alt Klavuz Profili / Aluminium Bottom Slider Profile | Eloksal / Mat Anodized | mt. | - | - | - 3,0 6,0 | 20 ad/pcs |
| 150-9770-1410 | Alüminyum Üst Ray Profili / Aluminium Top Rail Profile | Eloksal / Mat Anodized | mt. | - | - | - - 6,0 | 6 ad/pcs |

MultiDoor 450

60 KG ÇİFT YÖNE YAVAŞLATICILI HALATLI TELESKOPİK SÜRME KAPI SİSTEMİ • SOFTLINE TELESCOPIC SLIDING DOOR SYSTEMS

Yeni Ürün
New Product



Bilgi / Information

- Minimum kapı genişliği 810 mm olmalıdır.
- Min. Door width 810 mm

Yavaşlatıcı Alternatifi / Soft Closer Alternative

- Sistem üzerinde çift yöne yavaşlatıcı mevcuttur.
- The system has two way soft closing.



127-0452 1 Set İçeriği / 1 Set Includes



127-0451 1 Takım İçeriği (Opsiyonel Ek Kapı) / 1 Kit Includes (Optional Additional Door)



Ray Profilleri / Rail Profiles

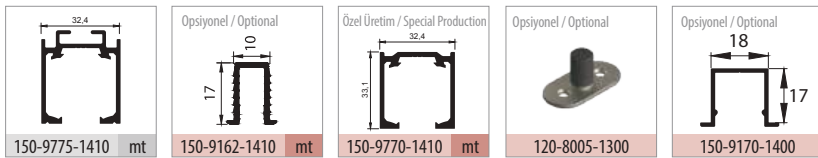

Teknik Detay / Technical Detail

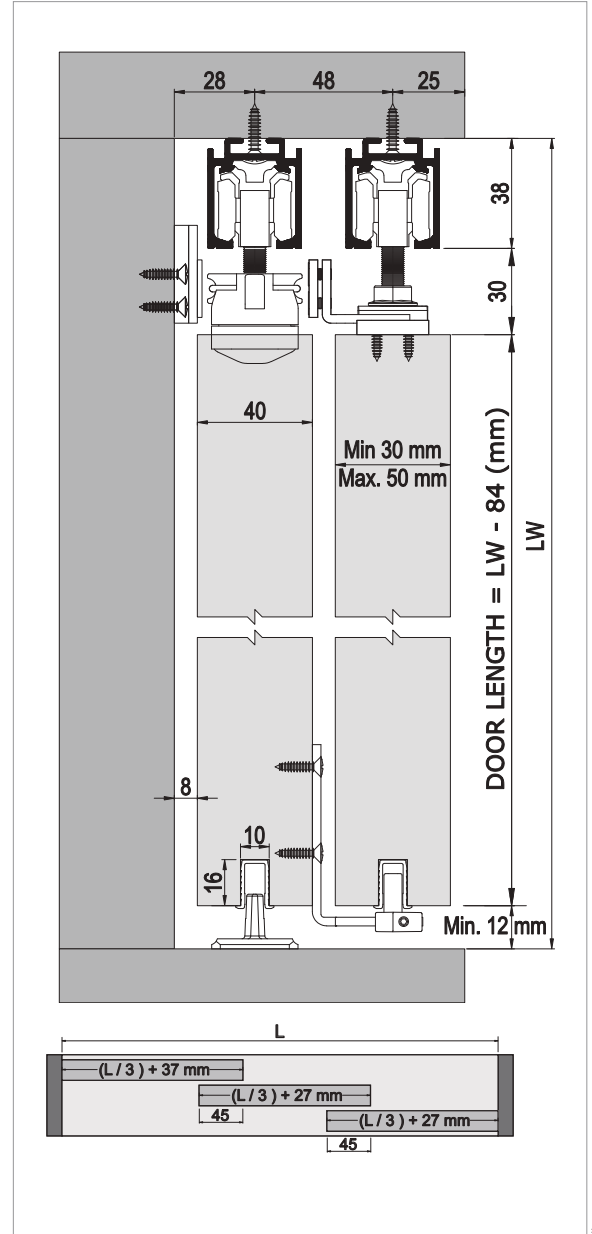

Ölçülerde değişiklik yapma hakkı saklıdır. Reserves the right to the change of the dimensions.

| Kod / Code No | Açıklama / Description | Renk / Colour | Birim / Unit | | | Profil mt. / Profiles mt. | Bağ / Bnd. |
|-------------------|--|------------------------|----------------|---|-----|---------------------------|------------|
| 127-0452-1410 | MultiDoor 452 Teleskopik Sürme Kapı Sistemi / Telescopic Sliding Door System | Gri / Grey | 2 Kapı / 1 Set | 4 | 144 | - | - |
| 127-0451-1410 | MultiDoor 451 İlave Kapı Sistemi / Additional Door System | Gri / Grey | 1 Kapı / 1 Kit | 4 | 144 | - | - |
| 127-0152-1300-510 | İlave Çelik Halat / Additional Wire Rope | Gri / Grey | mt. | - | - | - | - |
| 150-9775-1410 | Alüminyum Üst Ray Profili / Aluminium Top Rail Profile | Eloksal / Mat Anodized | mt. | - | - | 3,0 4,0 6,0 | 6 ad/pcs |
| 150-9162-1410 | Alüminyum Alt Klavuz Profili / Aluminium Bottom Slider Profile | Eloksal / Mat Anodized | mt. | - | - | - 3,0 6,0 | 20 ad/pcs |
| 150-9770-1410 | Alüminyum Üst Ray Profili / Aluminium Top Rail Profile | Eloksal / Mat Anodized | mt. | - | - | - - 6,0 | 6 ad/pcs |

Group 130

Underline®

Kapı Altı Giyotin Serisi
Door Seal Series

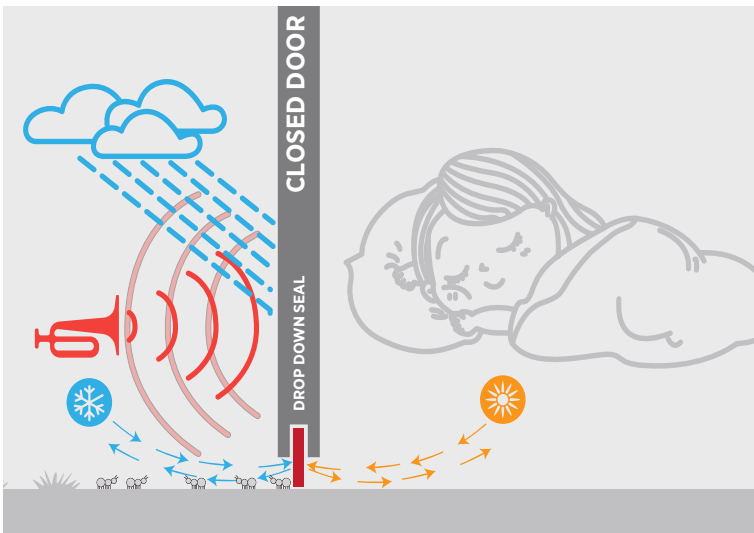
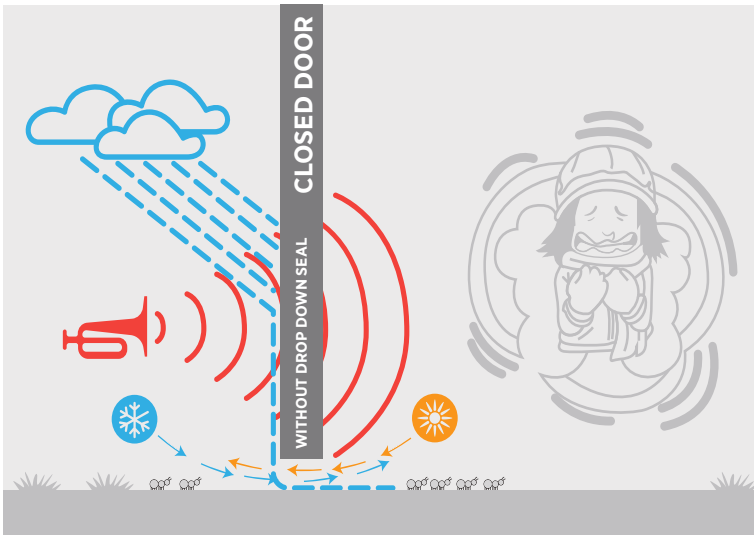

Bu serideki tüm ürünleri incelemek için QR kodu okutabilirsiniz.

You can search the QR code to see all the products in these series.

Underline

KAPI ALTI GIYOTIN SERİSİ • DOOR SEAL SERIES

Group **130**

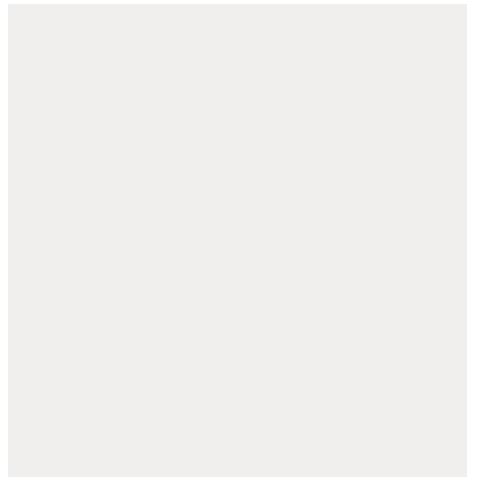
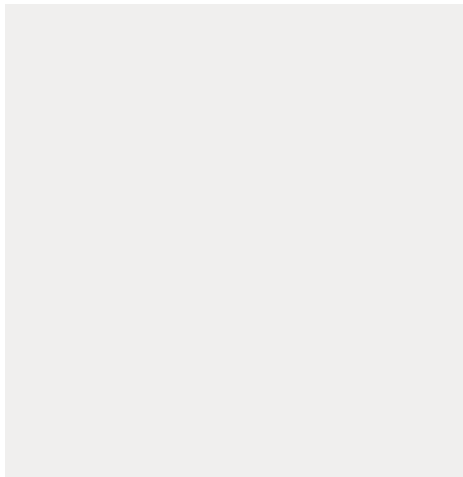
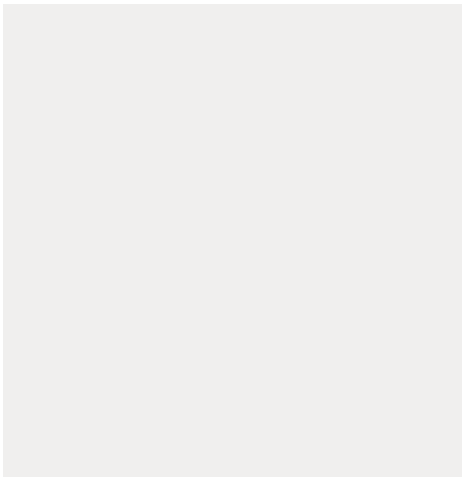
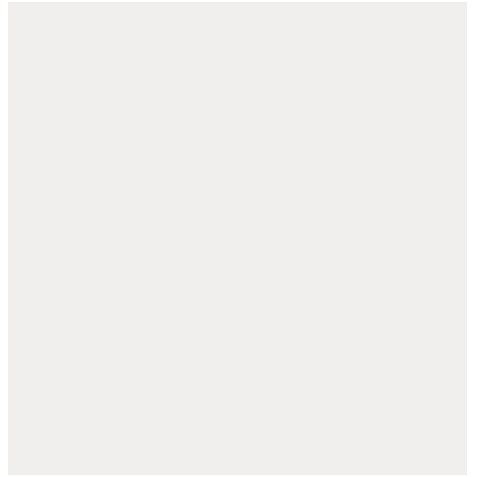
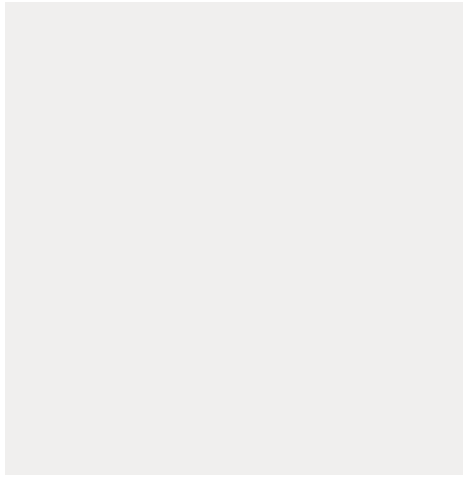
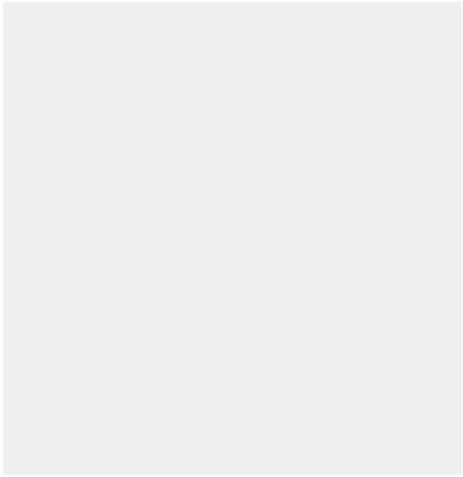
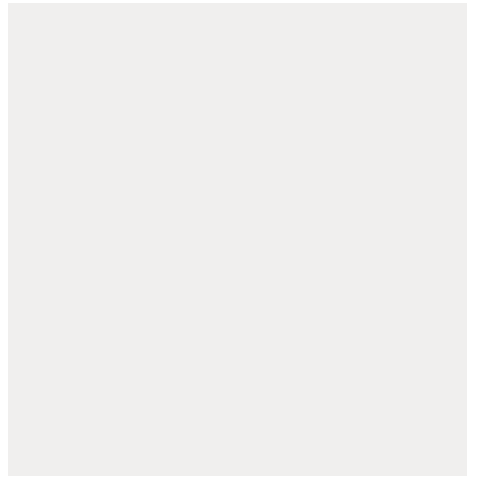

Underline 200

KAPI ALTI GIYOTINI • DOOR SEAL - INTERNAL



Bilgi / Information

- 0'dan 20 mm alt açıklığa kadar kapatabilme imkanı sunar.
- Mekanizma baskı ayarı yapılabilir.
- 10 cm. kadar kısaltma yapılabilir.
- Özel ölçü için lütfen müşteri temsilciniz ile irtibata geçiniz.
- Özel üretimlerde Minimum 200 adet sipariş kabul edilir.
- Usable for 0 - 20 mm drop
- Pressure can be adjusted
- Shortened up to 10 cm.
- Custom sizes, please contact your customer representative.
- Minimum 200 pcs orders are accepted in for special manufacturers.



Teknik Detay / Technical Detail

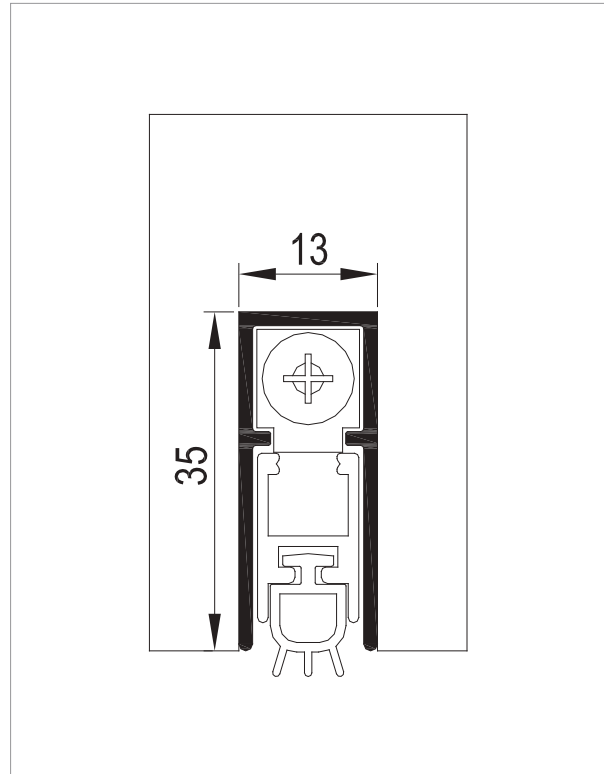

Ölçülerde değişiklik yapma hakkı saklıdır. Reserves the right to the change of the dimensions.

| Kod / Code No | Açıklama / Description | Renk / Colour | Boy / Size (mm) | Birim / Unit | | |
|--------------------|---|------------------------|-----------------|----------------|----|-----|
| 130-0200-1410-0530 | Kapı Altı Giyotini / Door Seal - Internal | Eloksal / Mat Anodized | 530 mm | 1 Adet / 1 Pcs | 10 | 360 |
| 130-0200-1410-0830 | Kapı Altı Giyotini / Door Seal - Internal | Eloksal / Mat Anodized | 830 mm | 1 Adet / 1 Pcs | 10 | 360 |
| 130-0200-1410-0930 | Kapı Altı Giyotini / Door Seal - Internal | Eloksal / Mat Anodized | 930 mm | 1 Adet / 1 Pcs | 10 | 360 |
| 130-0200-1410-1030 | Kapı Altı Giyotini / Door Seal - Internal | Eloksal / Mat Anodized | 1.030 mm | 1 Adet / 1 Pcs | 10 | 360 |
| 130-0200-1410-1130 | Kapı Altı Giyotini / Door Seal - Internal | Eloksal / Mat Anodized | 1.130 mm | 1 Adet / 1 Pcs | 10 | 360 |
| 130-0200-1410-1230 | Kapı Altı Giyotini / Door Seal - Internal | Eloksal / Mat Anodized | 1.230 mm | 1 Adet / 1 Pcs | 10 | 360 |

Underline 210

YANGIN DAYANIMLI KAPI ALTI GIYOTINI • DOOR SEAL FIRE PROTECTION



Bilgi / Information

- 0'dan 20 mm alt açıklığa kadar kapatabilme imkanı sunar.
- Mekanizma baskı ayarı yapılabilir.
- 10 cm. kadar kısaltma yapılabilir.
- Özel ölçü için lütfen müşteri temsilciniz ile irtibata geçiniz.
- Özel üretimlerde Minimum 200 adet sipariş kabul edilir.
- Usable for 0 - 20 mm drop
- Pressure can be adjusted
- Shortened up to 10 cm.
- Custom sizes, please contact your customer representative.
- Minimum 200 pcs orders are accepted in for special manufacturers.



Teknik Detay / Technical Detail

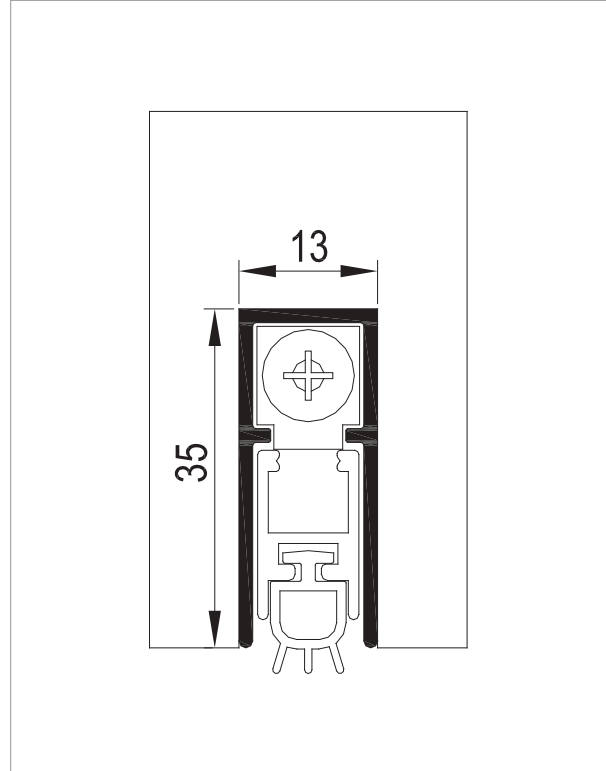

Ölçülerde değişiklik yapma hakkı saklıdır. Reserves the right to the change of the dimensions.

| Kod / Code No | Açıklama / Description | Renk / Colour | Boy / Size (mm) | Birim / Unit | | |
|--------------------|--|------------------------|-----------------|----------------|----|-----|
| 130-0210-1410-0830 | Yangına Dayanımlı Kapı Altı Giyotini / Door Seal (Fire Protection)- Internal | Eloksal / Mat Anodized | 830 mm | 1 Adet / 1 Pcs | 10 | 360 |
| 130-0210-1410-0930 | Yangına Dayanımlı Kapı Altı Giyotini / Door Seal (Fire Protection)- Internal | Eloksal / Mat Anodized | 930 mm | 1 Adet / 1 Pcs | 10 | 360 |
| 130-0210-1410-1030 | Yangına Dayanımlı Kapı Altı Giyotini / Door Seal (Fire Protection)- Internal | Eloksal / Mat Anodized | 1.030 mm | 1 Adet / 1 Pcs | 10 | 360 |
| 130-0210-1410-1130 | Yangına Dayanımlı Kapı Altı Giyotini / Door Seal (Fire Protection)- Internal | Eloksal / Mat Anodized | 1.130 mm | 1 Adet / 1 Pcs | 10 | 360 |
| 130-0210-1410-1230 | Yangına Dayanımlı Kapı Altı Giyotini / Door Seal (Fire Protection)- Internal | Eloksal / Mat Anodized | 1.230 mm | 1 Adet / 1 Pcs | 10 | 360 |

Underline 220

KAPI ALTI GIYOTINI-DIŞTAN • DOOR SEAL -EXTERNAL

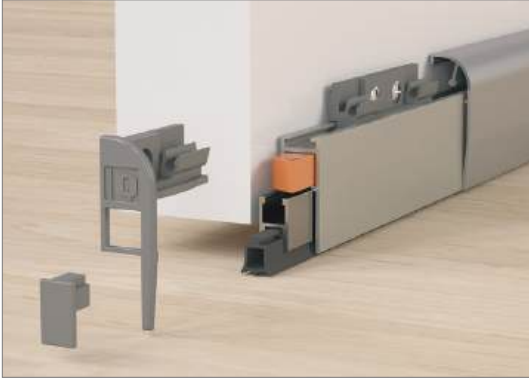

Bilgi / Information

- Tüm ahşap ve alüminyum kapı detaylarında kullanılabilir.
- 0'dan 20 mm alt açıklığa kadar kapatabilme imkanı sunar.
- Mekanizma baskı ayarı yapılabilir.
- 10 cm. kadar kısaltma yapılabilir.
- Özel ölçü için lütfen müşteri temsilciniz ile iletişime geçiniz.
- Özel üretimlerde Minimum 200 adet sipariş kabul edilir.
- Usable for wooden and aluminium doors
- Usable for 0 - 20 mm drop
- Pressure can be adjusted
- Shortened up to 10 cm.
- Custom sizes, please contact your customer representative.
- Minimum 200 pcs orders are accepted in for special manufacturers.



Teknik Detay / Technical Detail

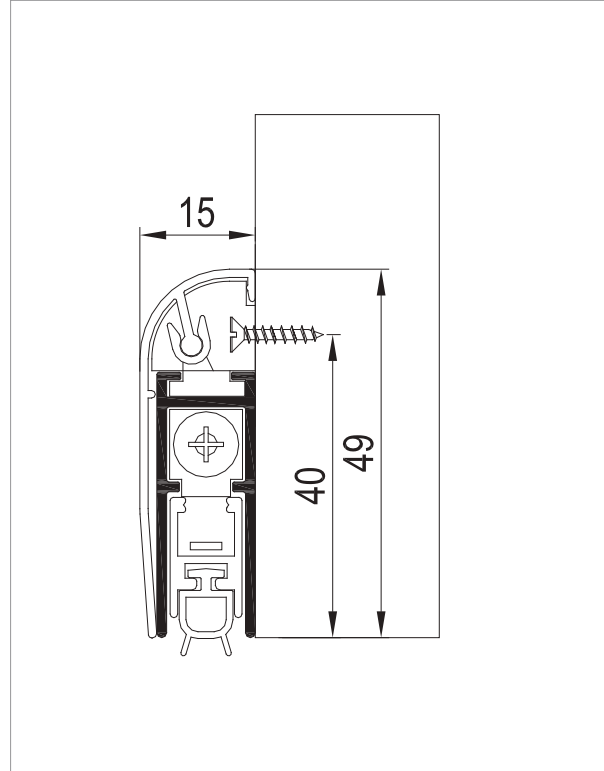

Ölçülerde değişiklik yapma hakkı saklıdır. Reserves the right to the change of the dimensions.

| Kod / Code No | Açıklama / Description | Renk / Colour | Boy / Size (mm) | Birim / Unit | | |
|--------------------|--|------------------------|-----------------|----------------|----|-----|
| 130-0220-1410-0530 | Kapı Altı Giyotini - Dıştan / Door Seal - External | Eloksal / Mat Anodized | 530 mm | 1 Adet / 1 Pcs | 10 | 360 |
| 130-0220-1410-0830 | Kapı Altı Giyotini - Dıştan / Door Seal - External | Eloksal / Mat Anodized | 830 mm | 1 Adet / 1 Pcs | 10 | 360 |
| 130-0220-1410-0930 | Kapı Altı Giyotini - Dıştan / Door Seal - External | Eloksal / Mat Anodized | 930 mm | 1 Adet / 1 Pcs | 10 | 360 |
| 130-0220-1410-1030 | Kapı Altı Giyotini - Dıştan / Door Seal - External | Eloksal / Mat Anodized | 1.030 mm | 1 Adet / 1 Pcs | 10 | 360 |
| 130-0220-1410-1130 | Kapı Altı Giyotini - Dıştan / Door Seal - External | Eloksal / Mat Anodized | 1.130 mm | 1 Adet / 1 Pcs | 10 | 360 |
| 130-0220-1410-1230 | Kapı Altı Giyotini - Dıştan / Door Seal - External | Eloksal / Mat Anodized | 1.230 mm | 1 Adet / 1 Pcs | 10 | 360 |

Underline 230

YANGINA DAYANIMLI KAPI ALTI GIYOTINI - DIŞTAN • DOOR SEAL FIRE PROTECTION-EXTERNAL



Bilgi / Information

- Tüm ahşap ve alüminyum kapı detaylarında kullanılabilir.
- 0'dan 20 mm alt açıklığa kadar kapatılma imkanı sunar.
- Mekanizma baskı ayarı yapılabilir.
- 10 cm. kadar kısaltma yapılabilir.
- Özel ölçü için lütfen müşteri temsilciniz ile irtibata geçiniz.
- Özel üretimlerde Minimum 200 adet sipariş kabul edilir.
- Usable for wooden and aluminium doors
- Usable for 0 - 20 mm drop
- Pressure can be adjusted
- Shortened up to 10 cm.
- Custom sizes, please contact your customer representative.
- Minimum 200 pcs orders are accepted in for special manufacturers.



Teknik Detay / Technical Detail



Yangın Dayanım Sertifikası / Fire Resistance Certificate

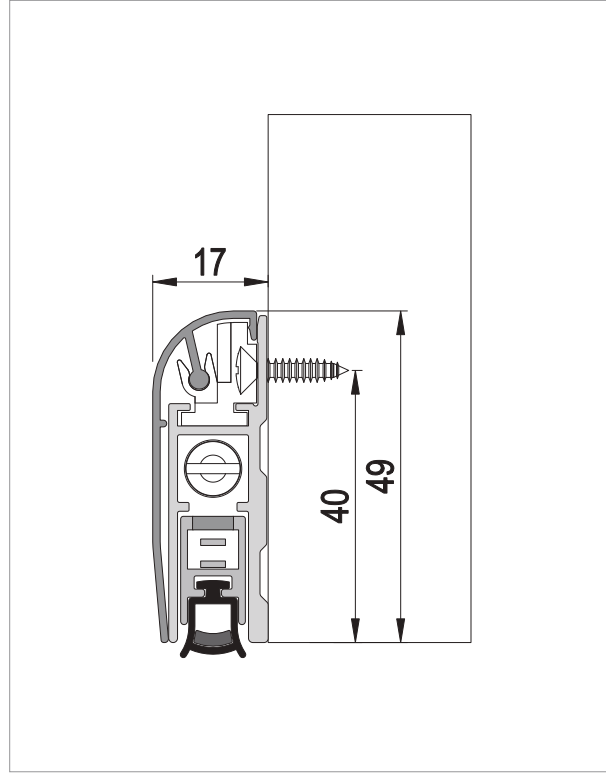

Ölçülerde değişiklik yapma hakkı saklıdır. Reserves the right to the change of the dimensions.

| Kod / Code No | Açıklama / Description | Renk / Colour | Boy / Size (mm) | Birim / Unit | | |
|--------------------|---|------------------------|-----------------|----------------|----|-----|
| 130-0230-1410-0830 | Yangına Dayanımlı Kapı Altı Giyotini-Dıştan / Door Seal (Fire Protection)- External | Eloksal / Mat Anodized | 830 mm | 1 Adet / 1 Pcs | 10 | 360 |
| 130-0230-1410-0930 | Yangına Dayanımlı Kapı Altı Giyotini-Dıştan / Door Seal (Fire Protection)- External | Eloksal / Mat Anodized | 930 mm | 1 Adet / 1 Pcs | 10 | 360 |
| 130-0230-1410-1030 | Yangına Dayanımlı Kapı Altı Giyotini-Dıştan / Door Seal (Fire Protection)- External | Eloksal / Mat Anodized | 1.030 mm | 1 Adet / 1 Pcs | 10 | 360 |
| 130-0230-1410-1130 | Yangına Dayanımlı Kapı Altı Giyotini-Dıştan / Door Seal (Fire Protection)- External | Eloksal / Mat Anodized | 1.130 mm | 1 Adet / 1 Pcs | 10 | 360 |
| 130-0230-1410-1230 | Yangına Dayanımlı Kapı Altı Giyotini-Dıştan / Door Seal (Fire Protection)- External | Eloksal / Mat Anodized | 1.230 mm | 1 Adet / 1 Pcs | 10 | 360 |



Bilgi / Information

- Tüm ahşap ve alüminyum kapı detaylarında kullanılabilir.
- 0'dan 13 mm alt açıklığa kadar kapatabilme imkanı sunar.
- Mekanizma baskı ayarı yapılabilir.
- 20 cm. kadar kısaltma yapılabilir.
- Özel ölçü için lütfen müşteri temsilciniz ile iletişime geçiniz.
- Özel üretimlerde minimum 200 adet sipariş kabul edilir.
- Usable for wooden and aluminium doors
- Usable for 0 - 13 mm drop
- Pressure can be adjusted
- Shortened up to 20 cm.
- Custom sizes, please contact your customer representative.
- Minimum 200 pcs orders are accepted in for special manufacturers.



Teknik Detay / Technical Detail

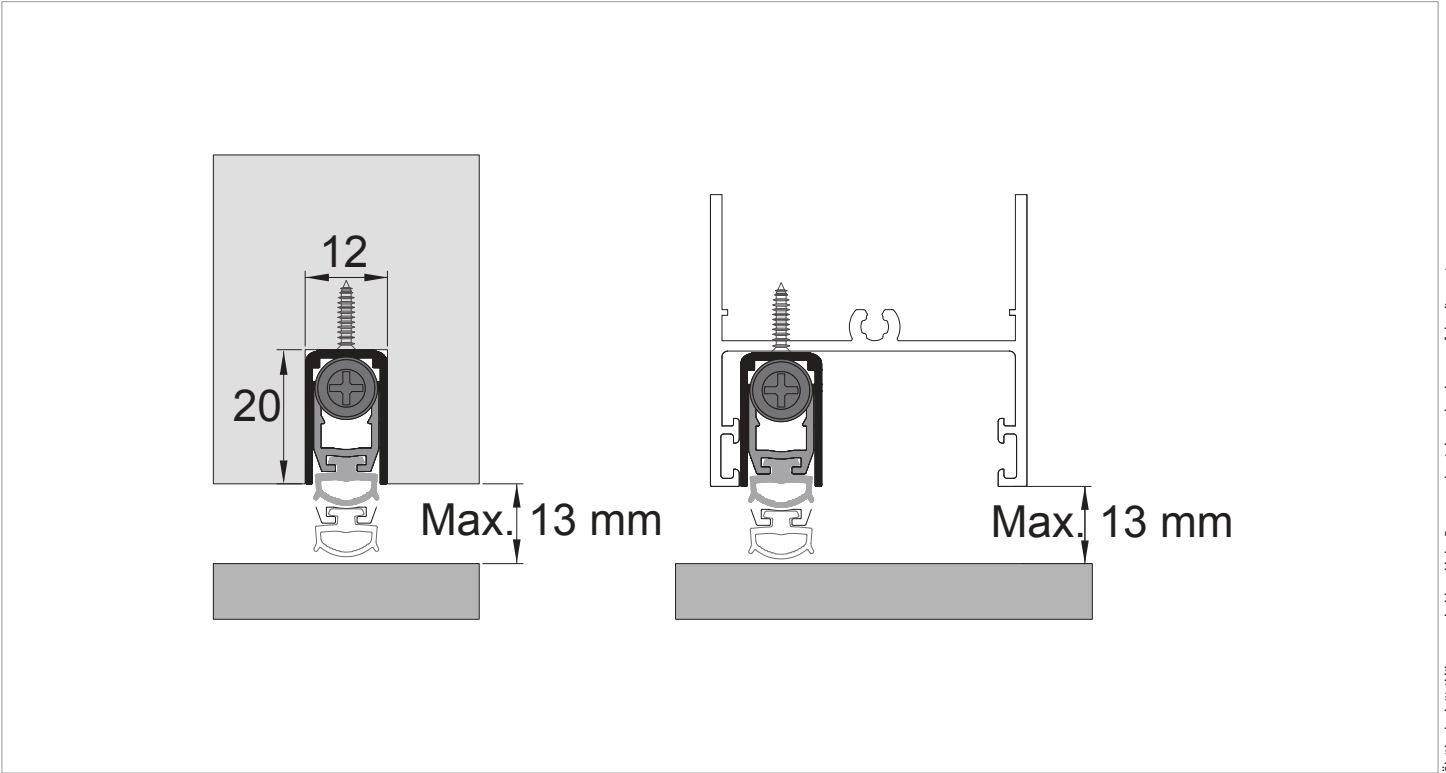

Ölçülerde değişiklik yapma hakkı saklıdır. Reserves the right to the change of the dimensions.

| Kod / Code No | Açıklama / Description | Renk / Colour | Boy / Size (mm) | Birim / Unit | | |
|--------------------|---|------------------------|-----------------|----------------|----|-----|
| 130-0300-1410-0460 | Underline 300 - Kapı Altı Giyotini / Door Seal - Internal | Eloksal / Mat Anodized | 460 mm | 1 Adet / 1 Pcs | 10 | 360 |
| 130-0300-1410-0630 | Underline 300 - Kapı Altı Giyotini / Door Seal - Internal | Eloksal / Mat Anodized | 630 mm | 1 Adet / 1 Pcs | 10 | 360 |
| 130-0300-1410-0830 | Underline 300 - Kapı Altı Giyotini / Door Seal - Internal | Eloksal / Mat Anodized | 830 mm | 1 Adet / 1 Pcs | 10 | 360 |
| 130-0300-1410-1030 | Underline 300 - Kapı Altı Giyotini / Door Seal - Internal | Eloksal / Mat Anodized | 1.030 mm | 1 Adet / 1 Pcs | 10 | 360 |
| 130-0300-1410-1230 | Underline 300 - Kapı Altı Giyotini / Door Seal - Internal | Eloksal / Mat Anodized | 1.230 mm | 1 Adet / 1 Pcs | 10 | 360 |



Underline 200

KAPI ALTI GIYOTINI • DOOR SEAL

albaturas.com

Group 131

Door Hardware

Kapı Donanımları



Bu serideki tüm ürünleri incelemek için QR kodu okutabilirsiniz.

You can search the QR code to see all the products in these series.

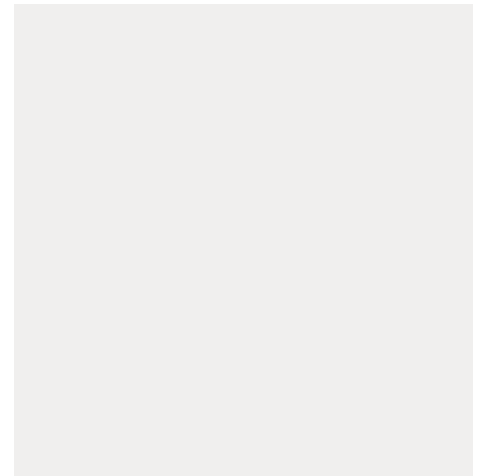
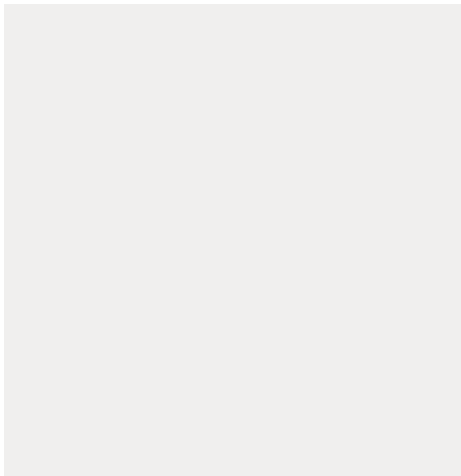
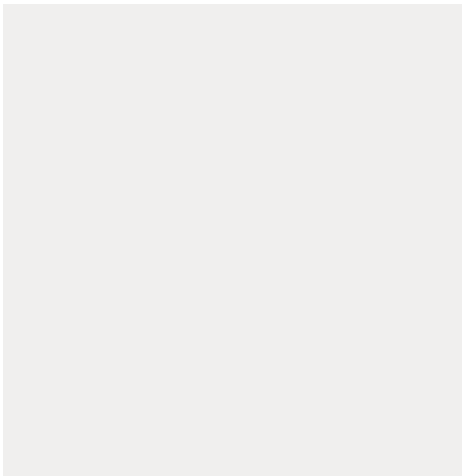
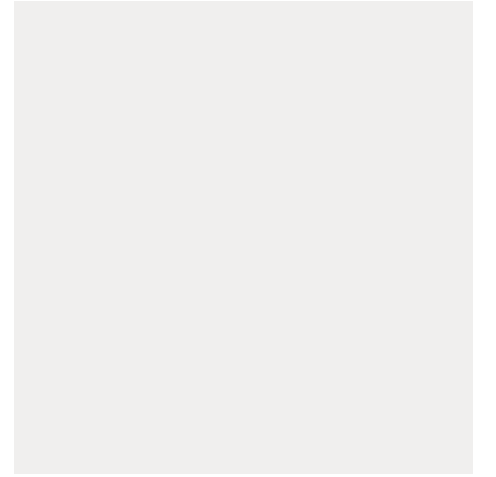

131-0100

KİLİT KARŞILIĞI CEBİ • LOCK POCKET

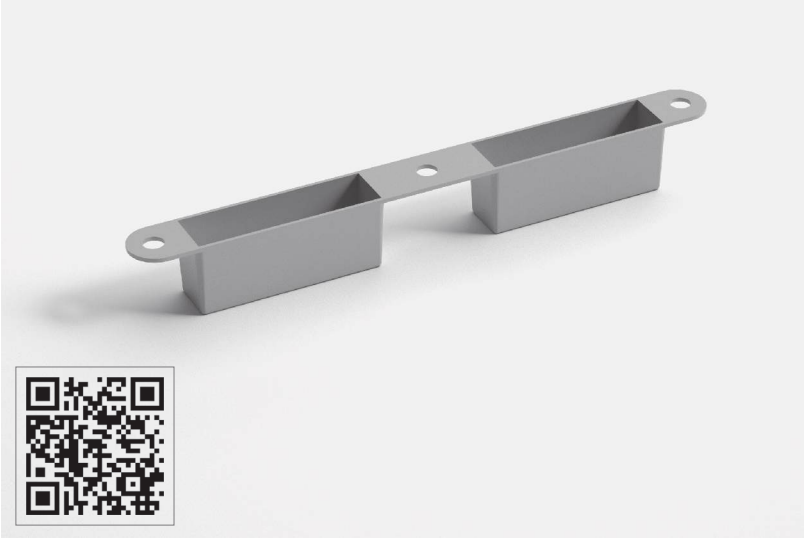

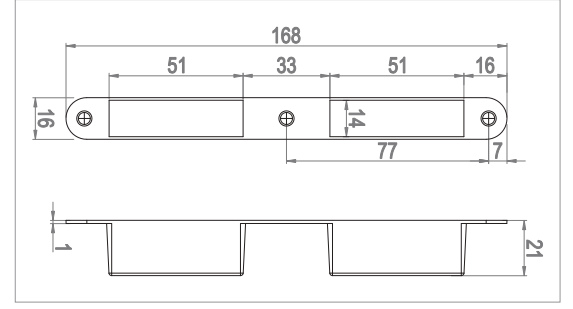

Teknik Detay / Technical Detail



Bilgi / Information

- Ahşap kapılarda kilit karşılığının altındaki detayı kapatmak amacı ile kullanılır.
- Kullanımda olan kilit DIN normlarına uygundur.
- It is used to close the details bottom of the door lock striker on the doors of wood
- Suitable for lock DIN standarts which use in the markets

| Kod / Code No | Açıklama / Description | Renk / Colour | Birim / Unit |  |  |
|---------------|------------------------------------|---------------|----------------|---|---|
| 131-0100-1660 | Kilit Karşılığı Cebi / Lock Pocket | Krem / Cream | 1 Adet / 1 Pcs | 100 | 6.000 |
| 131-0100-1650 | Kilit Karşılığı Cebi / Lock Pocket | Beyaz / White | 1 Adet / 1 Pcs | 100 | 6.000 |
| 131-0100-1670 | Kilit Karşılığı Cebi / Lock Pocket | Kahve / Brown | 1 Adet / 1 Pcs | 100 | 6.000 |
| 131-0100-1600 | Kilit Karşılığı Cebi / Lock Pocket | Gri / Grey | 1 Adet / 1 Pcs | 100 | 6.000 |

131-0110

KİLİT KARŞILIĞI CEBİ • LOCK POCKET



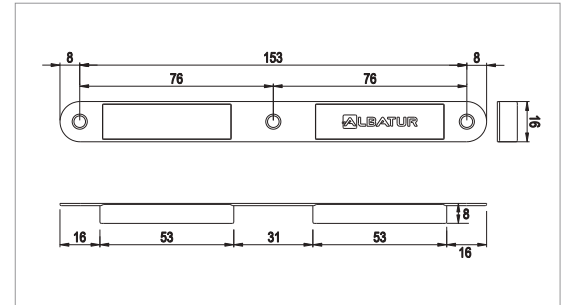

Teknik Detay / Technical Detail



Bilgi / Information

- Ahşap kapılarda kilit karşılığının altındaki detayı kapatmak amacı ile kullanılır.
- Kullanımda olan kilit DIN normlarına uygundur.
- It is used to close the details bottom of the door lock striker on the doors of wood
- Suitable for lock DIN standarts which use in the markets

| Kod / Code No | Açıklama / Description | Renk / Colour | Birim / Unit |  |  |
|---------------|------------------------------------|---------------|----------------|---|---|
| 131-0110-1660 | Kilit Karşılığı Cebi / Lock Pocket | Krem / Cream | 1 Adet / 1 Pcs | 100 | 6.000 |
| 131-0110-1650 | Kilit Karşılığı Cebi / Lock Pocket | Beyaz / White | 1 Adet / 1 Pcs | 100 | 6.000 |
| 131-0110-1670 | Kilit Karşılığı Cebi / Lock Pocket | Kahve / Brown | 1 Adet / 1 Pcs | 100 | 6.000 |

131-0120

KİLİT KARŞILIĞI CEBİ • LOCK POCKET

YeniÜrün
NewProduct

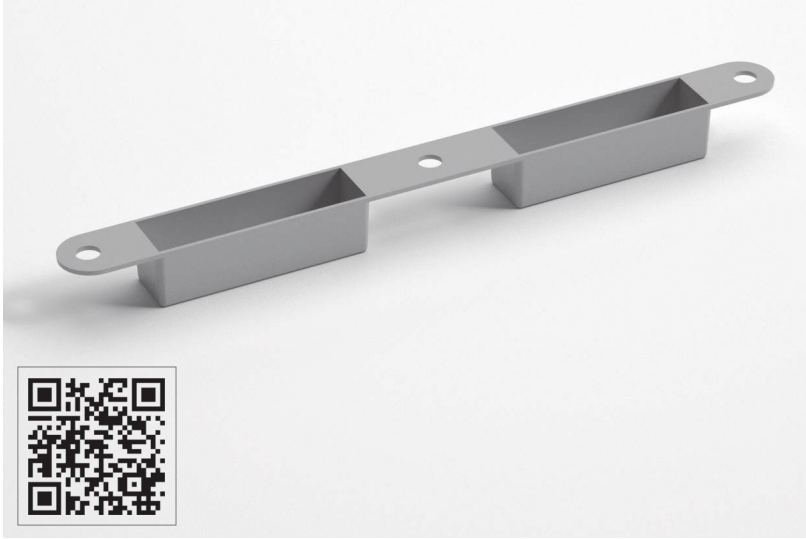

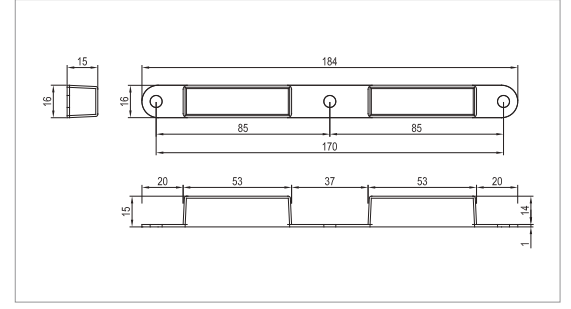

Teknik Detay / Technical Detail



Bilgi / Information

- Ahşap kapılarda kilit karşılığının altındaki detayı kapatmak amacı ile kullanılır.
- Kullanımda olan kilit DIN normlarına uygundur.
- It is used to close the details bottom of the door lock striker on the doors of wood
- Suitable for lock DIN standarts which use in the markets

| Kod / Code No | Açıklama / Description | Renk / Colour | Birim / Unit |  |  |
|---------------|------------------------------------|---------------|----------------|--|--|
| 131-0120-1600 | Kilit Karşılığı Cebi / Lock Pocket | Gri / Grey | 1 Adet / 1 Pcs | 100 | 6.000 |

131-0130

KİLİT KARŞILIĞI CEBİ • LOCK POCKET

YeniÜrün
NewProduct

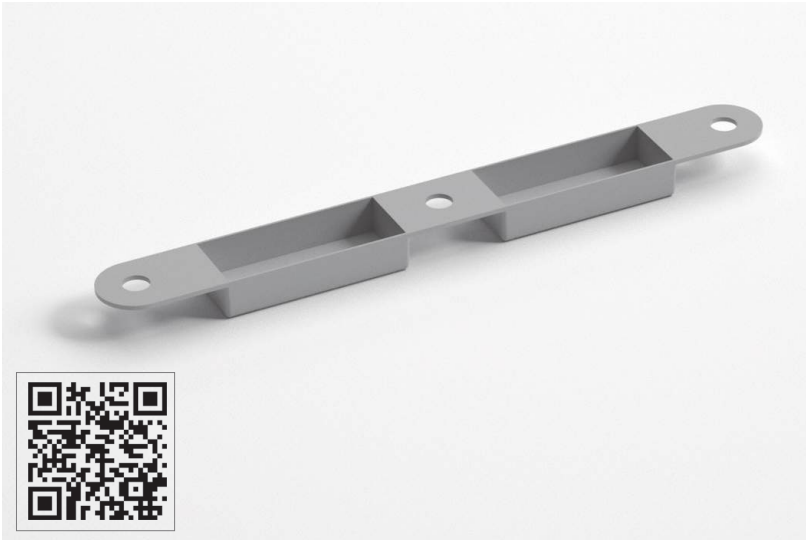

Teknik Detay / Technical Detail

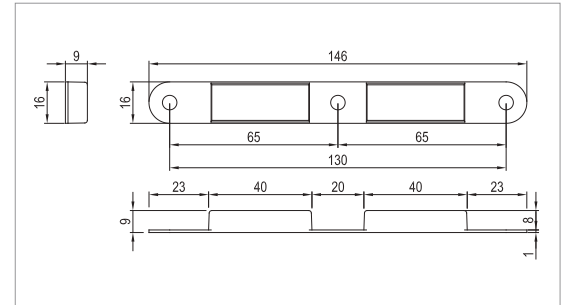

Bilgi / Information

- Ahşap kapılarda kilit karşılığının altındaki detayı kapatmak amacı ile kullanılır.
- Kullanımda olan kilit DIN normlarına uygundur.
- It is used to close the details bottom of the door lock striker on the doors of wood
- Suitable for lock DIN standarts which use in the markets

| Kod / Code No | Açıklama / Description | Renk / Colour | Birim / Unit |  |  |
|---------------|------------------------------------|---------------|----------------|---|---|
| 131-0130-1600 | Kilit Karşılığı Cebi / Lock Pocket | Gri / Grey | 1 Adet / 1 Pcs | 100 | 6.000 |

131-0200



OTOMATİK KAPI SÜRGÜSÜ (YÖNSÜZ) • AUTOMATIC DOOR BOLT (NONDIRECTIVE)

Yeni Ürün
New Product

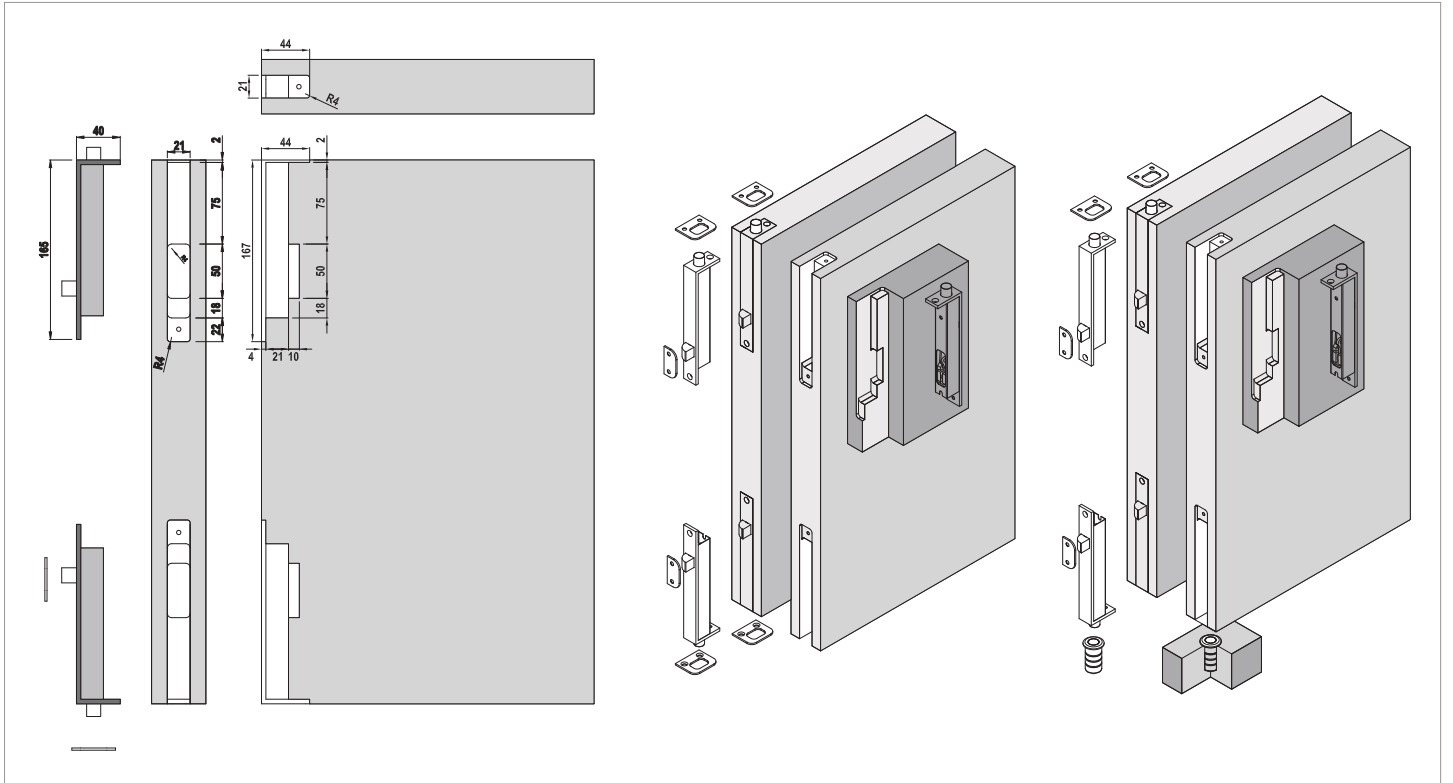

Teknik Detay / Technical Detail



| Kod / Code No | Açıklama / Description | Renk / Colour | Birim / Unit |  |  |
|---------------|---|---------------|----------------|---|---|
| 131-0200-1810 | Otomatik Kapı Sürgüsü (Yönsüz) / Automatic Door Bolt (Nondirective) | Altın / Gold | 1 Adet / 1 Pcs | 24 | 480 |
| 131-0200-1820 | Otomatik Kapı Sürgüsü (Yönsüz) / Automatic Door Bolt (Nondirective) | Saten / Satin | 1 Adet / 1 Pcs | 24 | 480 |

131-0210

YER SOKETİ • DUST PROOF STRIKE

Yeni Ürün
New Product



1 Set İçeriği / 1 Set Includes



131-0210-1820

1 Set İçeriği / 1 Set Includes



131-0210-1810



Teknik Detay / Technical Detail

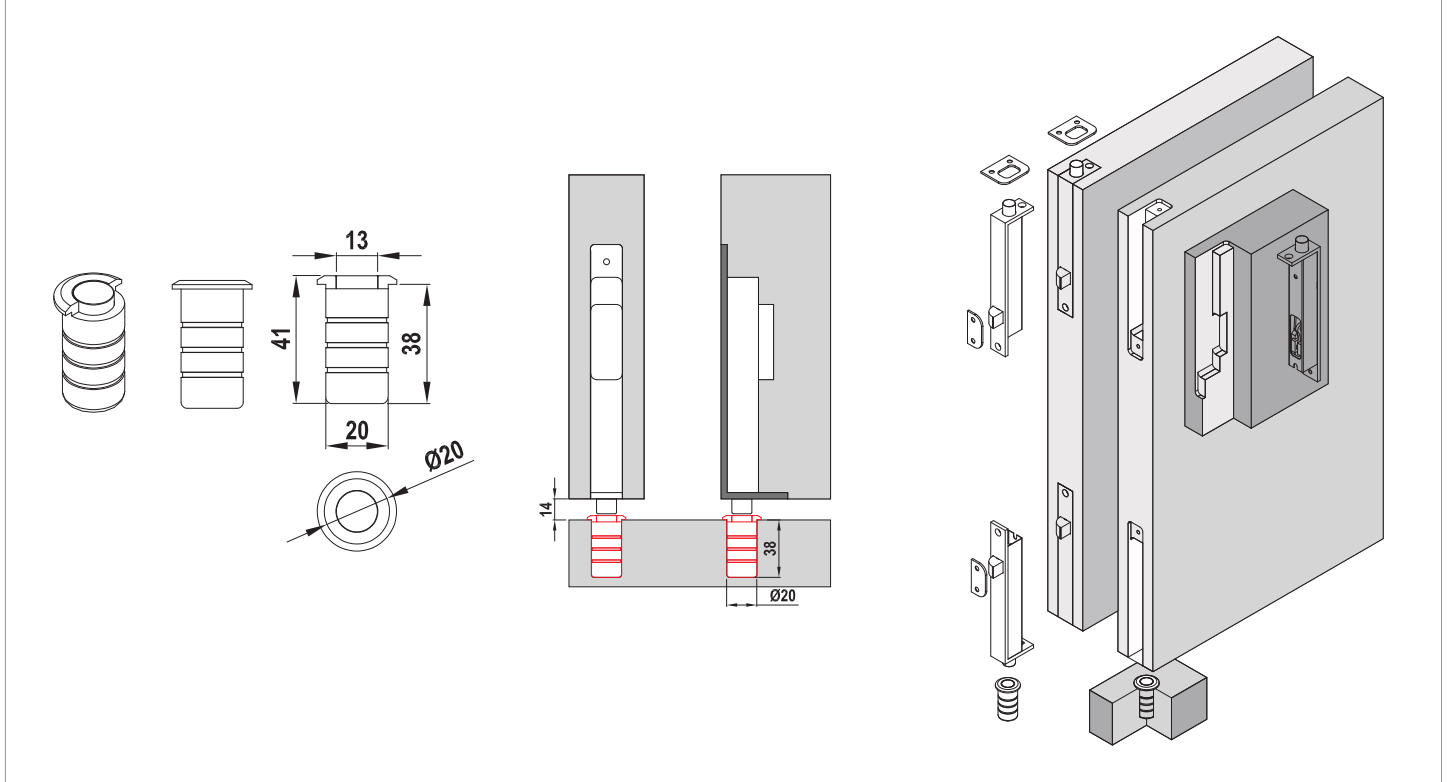

| Kod / Code No | Açıklama / Description | Renk / Colour | Birim / Unit | | |
|---------------|--------------------------------|---------------|----------------|----|-----|
| 131-0210-1810 | Yer Soketi • Dust Proof Strike | Altın / Gold | 1 Adet / 1 Pcs | 24 | 480 |
| 131-0210-1820 | Yer Soketi • Dust Proof Strike | Saten / Satin | 1 Adet / 1 Pcs | 24 | 480 |

Menteşe

ÇELİK MENTEŞE • STEEL HINGE



■ Teknik Detay / Technical Detail

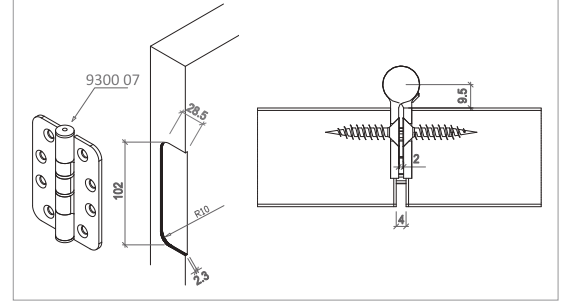

■ Bilgi / Information

• Taşıma kapasitesi, 1 kanat için 3 menteşe kullanılarak 80 kg kadardır.

• Carrying capacity : For 1 door 3 hinges using maximum to 80 kg

| Kod / Code No | Açıklama / Description | Renk / Colour | Birim / Unit |  |  |
|-------------------|-----------------------------|-----------------------|----------------|--|--|
| 122-9300-1410-507 | Çelik Menteşe / Steel Hinge | Galvaniz / Galvanized | 1 Adet / 1 Pcs | 50 | 4800 |

Menteşe

ÇELİK MENTEŞE • STEEL HINGE

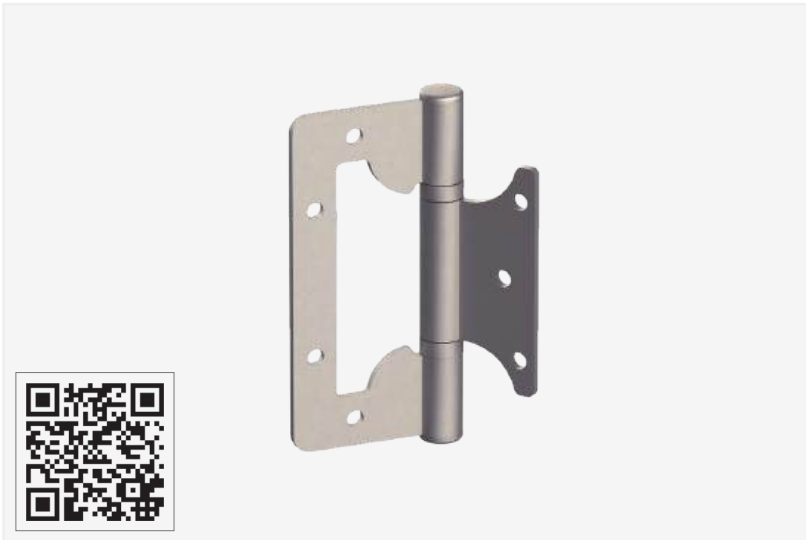

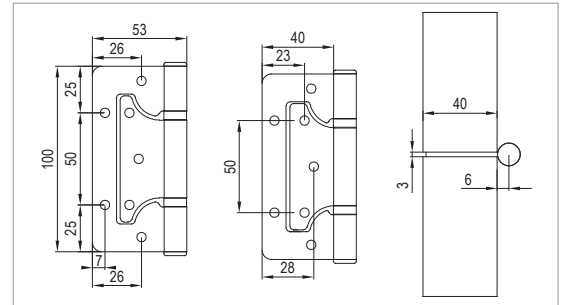

■ Teknik Detay / Technical Detail



■ Bilgi / Information

• Taşıma kapasitesi, 1 kanat için 3 menteşe kullanılarak 40 kg kadardır.

• Carrying capacity : For 1 door 3 hinges using maximum to 40 kg

| Kod / Code No | Açıklama / Description | Renk / Colour | Birim / Unit |  |  |
|-------------------|-----------------------------|-----------------------|----------------|---|---|
| 122-9061-1300-505 | Çelik Menteşe / Steel Hinge | Galvaniz / Galvanized | 1 Adet / 1 Pcs | 50 | 4800 |



Domino 180

180 DERECE AÇILIR KATLANIR KAPI DONANIMI

albaturas.com

Group 135

MagicLift[®]

Gardırop Donanımları Serisi

Wardrobe Equipments Series



Bu serideki tüm ürünleri incelemek için QR kodu okutabilirsiniz.

You can search the QR code to see all the products in these series.

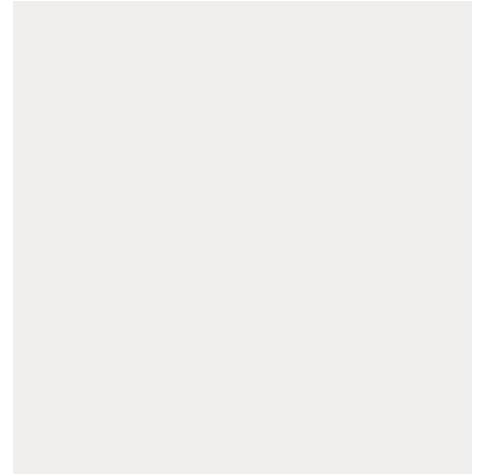
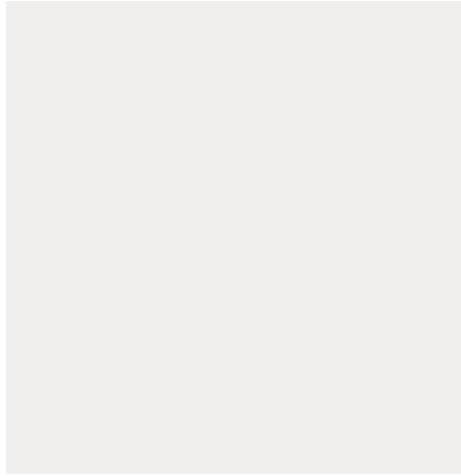
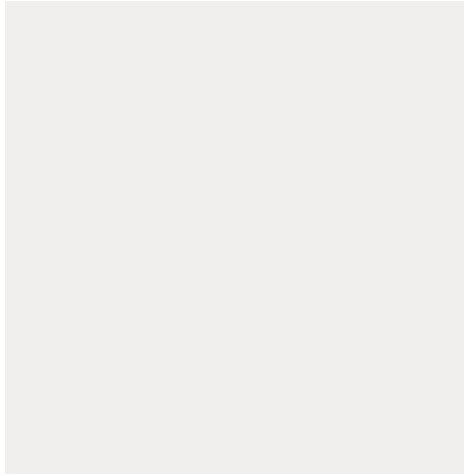
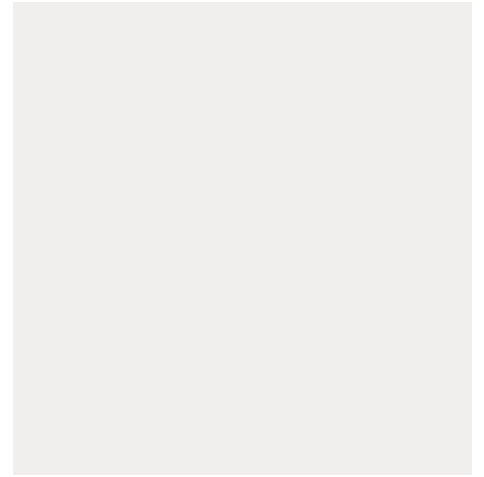
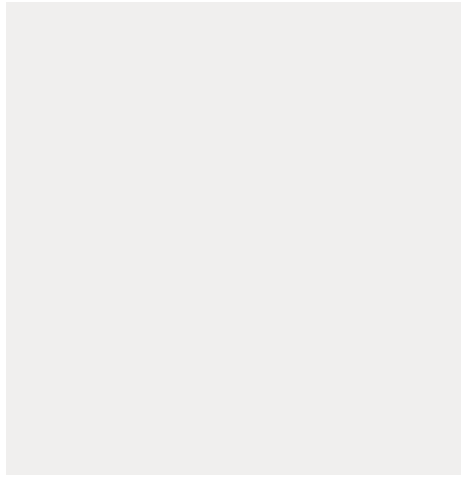
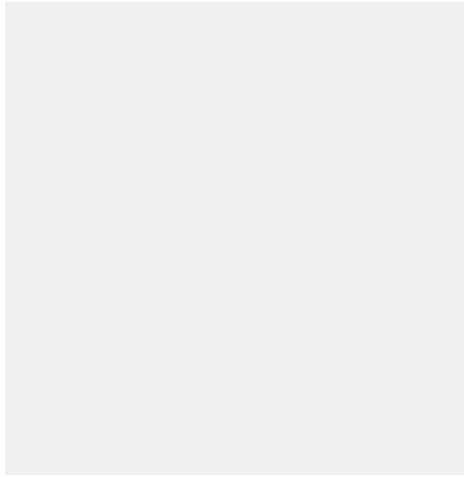
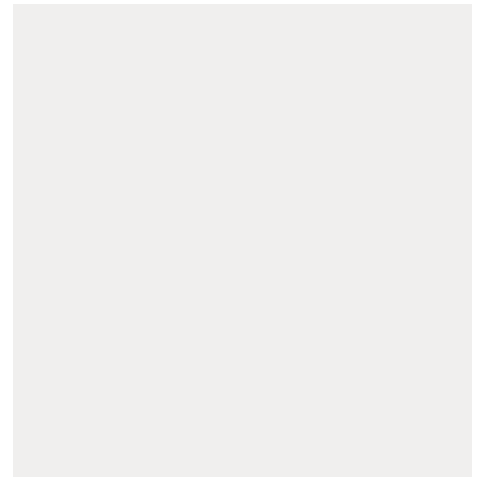
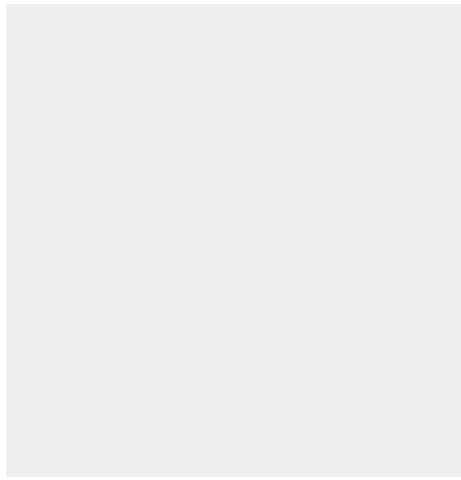

MagicLift 1100

15 KG GARDIROP ASANSÖRÜ • LIFT FOR WARDROBE



OIL
DAMPER



■ Bilgi / Information

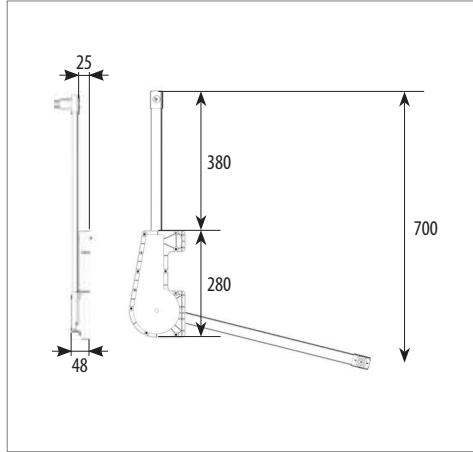
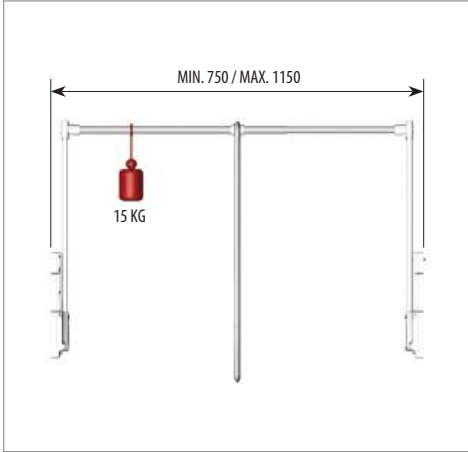
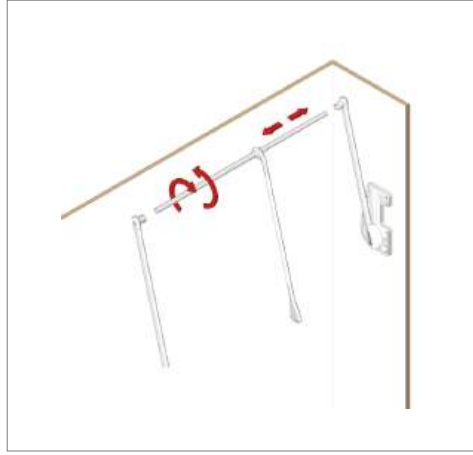

Ölçülerde değişiklik yapma hakkı saklıdır. Reserves the right to the change of the dimensions.

| Kod / Code No | Açıklama / Description | Renk / Colour | Birim / Unit | | |
|---------------|---|-----------------------|----------------|---|----|
| 135-1100-3610 | MagicLift 15 Kg - Gardirop asansörü / Lift For Wardrobe | Gri / Grey | 1 Adet / 1 Pcs | 6 | 72 |
| 135-1100-3620 | MagicLift 15 Kg - Gardirop asansörü / Lift For Wardrobe | Antrasit / Anthracite | 1 Adet / 1 Pcs | 6 | 72 |

MagicLift 1110

10 KG GARDIROP ASANSÖRÜ • LIFT FOR WARDROBE

Özel Üretim
Special Production



OIL
DAMPER

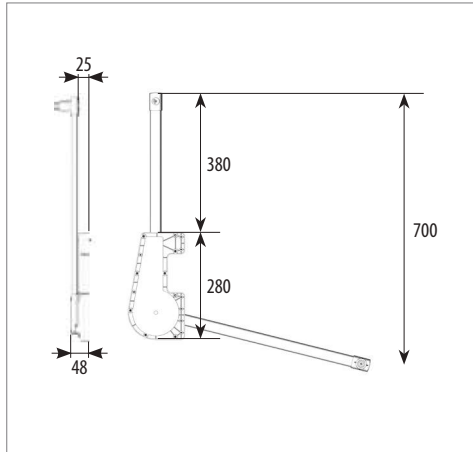
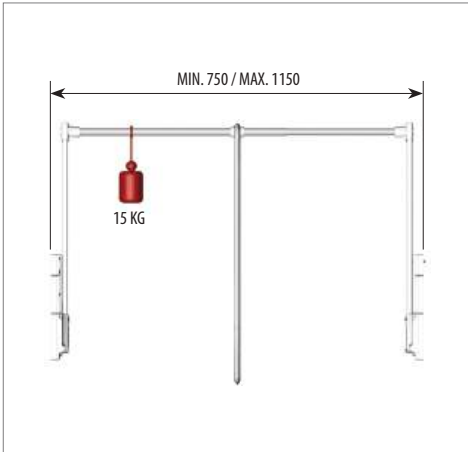
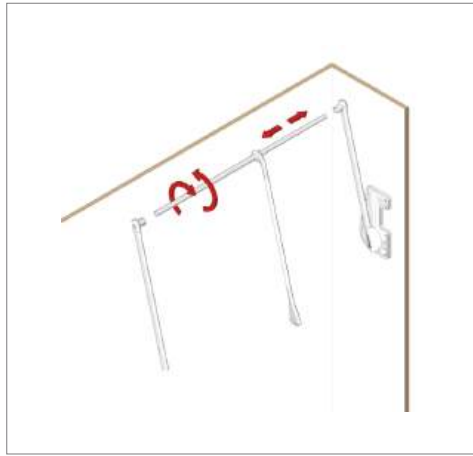

■ Bilgi / Information

Öçülerde deęişiklik yapma hakkı saklıdır. Reserves the right to the change of the dimensions.

| Kod / Code No | Açıklama / Description | Renk / Colour | Birim / Unit | | |
|---------------|---|-----------------------|----------------|---|----|
| 135-1110-3610 | MagicLift 10 Kg - Gardirop asansörü / Lift For Wardrobe | Gri / Grey | 1 Adet / 1 Pcs | 6 | 72 |
| 135-1110-3620 | MagicLift 10 Kg - Gardirop asansörü / Lift For Wardrobe | Antrasit / Anthracite | 1 Adet / 1 Pcs | 6 | 72 |

135-1101

GARDIROP ASANSÖRÜ MONTAJ APARATI • LIFT FOR WARDROBE MOUNTING APPARATUS



| Kod / Code No | Açıklama / Description | Renk / Colour | Birim / Unit | | |
|---------------|---|-----------------------|----------------|---|----|
| 135-1101-3610 | Gardırop Asansörü Montaj Aparatı • Lift For Wardrobe Mounting Apparatus | Gri / Grey | 1 Adet / 1 Pcs | 6 | 72 |
| 135-1101-3620 | Gardırop Asansörü Montaj Aparatı • Lift For Wardrobe Mounting Apparatus | Antrasit / Anthracite | 1 Adet / 1 Pcs | 6 | 72 |



MagicLift 1100

GARDIROP ASANSÖRÜ

albaturas.com

MagicLift 1200

12 KG GARDIROP ASANSÖRÜ • LIFT FOR WARDROBE

Yeni Ürün
New Product



OIL
DAMPER

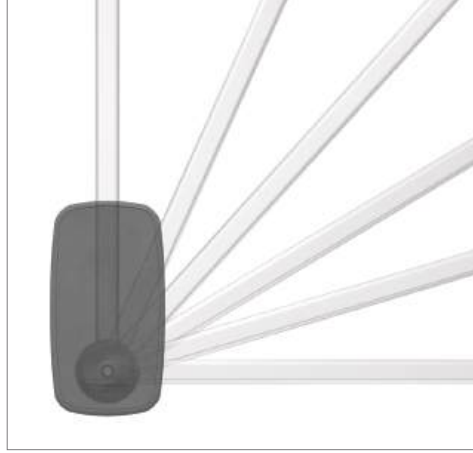
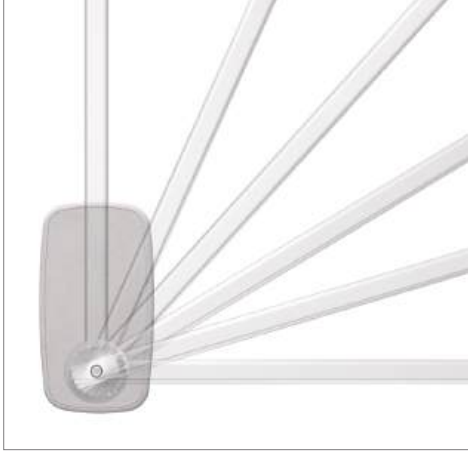
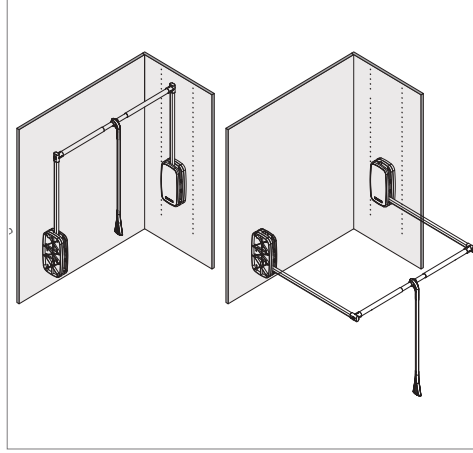
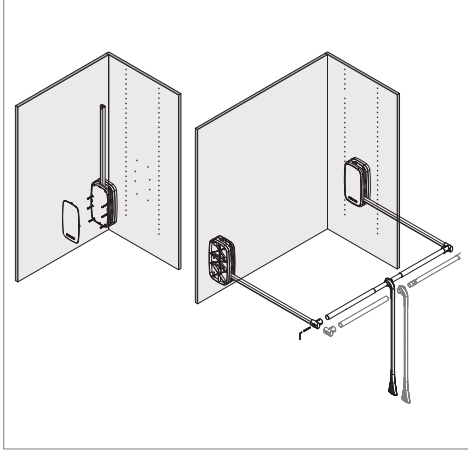
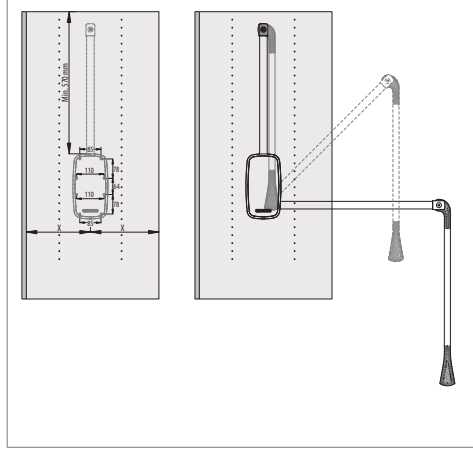
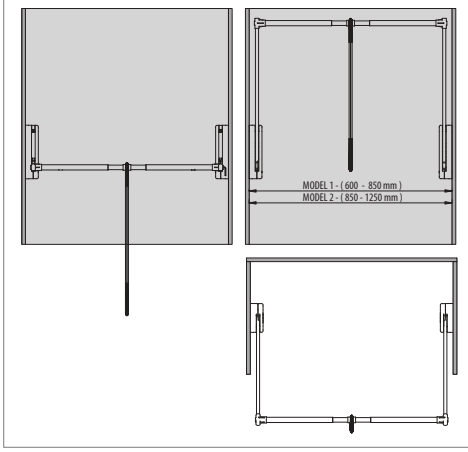

Bilgi / Information

Ölülerde değişiklik yapma hakkı saklıdır. Reserves the right to the change of the dimensions.

| Kod / Code No | Açıklama / Description | Renk / Colour | Birim / Unit | | |
|---------------|---|-----------------------|----------------|---|----|
| 135-1200-3610 | MagicLift 12 Kg - Gardirop asansörü / Lift For Wardrobe | Gri / Grey | 1 Adet / 1 Pcs | 6 | 72 |
| 135-1200-3620 | MagicLift 12 Kg - Gardirop asansörü / Lift For Wardrobe | Antrasit / Anthracite | 1 Adet / 1 Pcs | 6 | 72 |



albaturas.com

Group 140

Ventil® Aluminium

Alüminyum Dekoratif Menfez Serisi

Aluminium Air Ventilation Cover Series

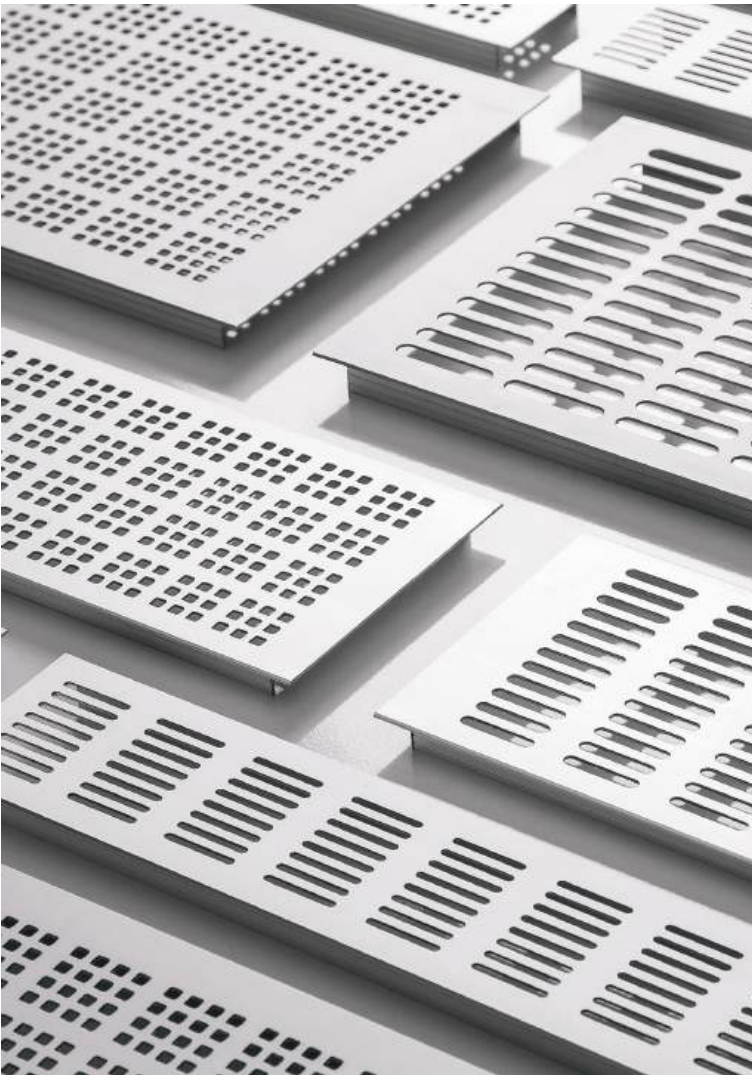

Bu serideki tüm ürünleri incelemek için QR kodu okutabilirsiniz.

You can search the QR code to see all the products in these series.

Ventil Aluminium

ALÜMİNYUM DEKORATİF MENFEZ • ALUMINIUM AIR VENTILATION COVER

Group **140**



Ventil **440**



Ventil **460**

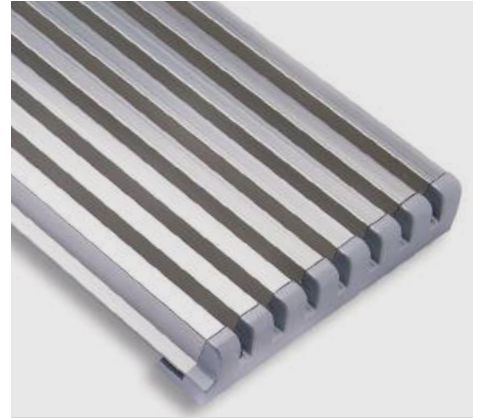

Ventil **480**

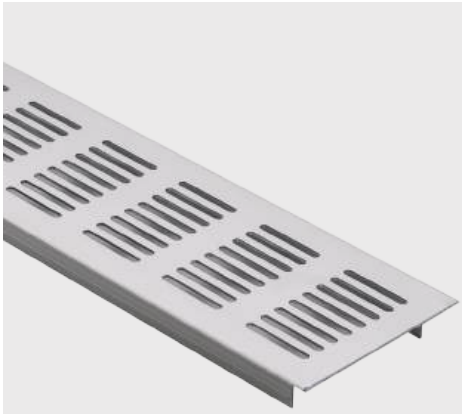

Ventil **900**

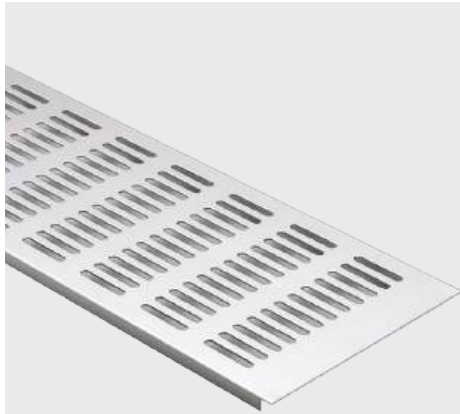

Ventil **700**

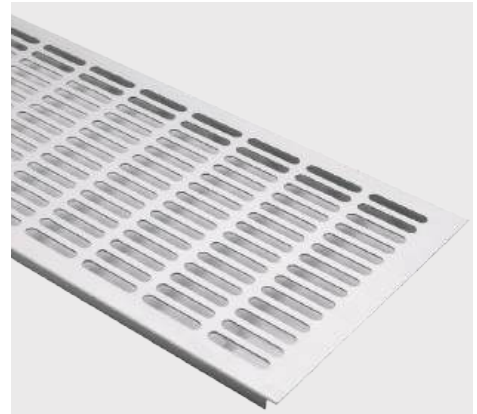

Ventil **750**



Ventil **950**

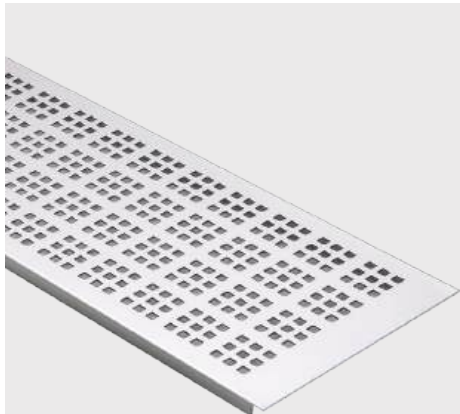

Ventil **800**

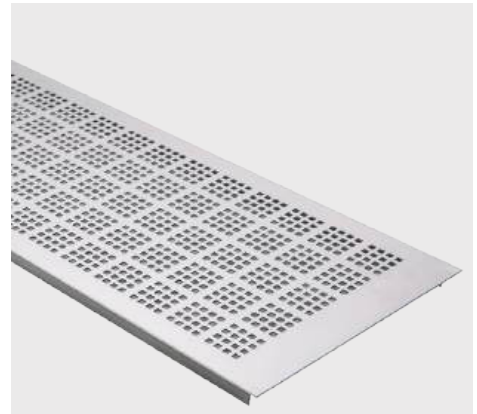

Ventil **850**

Ventil Aluminium

ALÜMİNYUM DEKORATİF MENFEZ • ALUMINIUM AIR VENTILATION COVER

140-0440 • BAR MENFEZ • AIR VENTILATION COVER



Bilgi / Information

- Eni 60 mm
- Width 60 mm

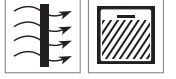

| Kod / Code No | Boy / Size | Renk / Colour | Birim / Unit |  |  |
|--------------------|------------|------------------------|----------------|---|---|
| 140-0440-1410-0423 | 423 mm | Eloksal / Mat Anodized | 1 Adet / 1 Pcs | 10 | 630 |
| 140-0440-1410-0610 | 610 mm | Eloksal / Mat Anodized | 1 Adet / 1 Pcs | 10 | 420 |
| 140-0440-1410-0900 | 900 mm | Eloksal / Mat Anodized | 1 Adet / 1 Pcs | 10 | 420 |
| 140-0440-1420-0423 | 423 mm | Parlak / Bright | 1 Adet / 1 Pcs | 10 | 630 |
| 140-0440-1420-0610 | 610 mm | Parlak / Bright | 1 Adet / 1 Pcs | 10 | 420 |
| 140-0440-1420-0900 | 900 mm | Parlak / Bright | 1 Adet / 1 Pcs | 10 | 420 |

140-0460 • BAR MENFEZ • AIR VENTILATION COVER



Bilgi / Information

- Eni 90 mm
- Width 90 mm

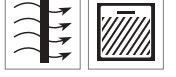

| Kod / Code No | Boy / Size | Renk / Colour | Birim / Unit |  |  |
|--------------------|------------|------------------------|----------------|---|---|
| 140-0460-1410-0423 | 423 mm | Eloksal / Mat Anodized | 1 Adet / 1 Pcs | 10 | 630 |
| 140-0460-1410-0610 | 610 mm | Eloksal / Mat Anodized | 1 Adet / 1 Pcs | 10 | 420 |
| 140-0460-1410-0900 | 900 mm | Eloksal / Mat Anodized | 1 Adet / 1 Pcs | 10 | 420 |
| 140-0460-1420-0423 | 423 mm | Parlak / Bright | 1 Adet / 1 Pcs | 10 | 630 |
| 140-0460-1420-0610 | 610 mm | Parlak / Bright | 1 Adet / 1 Pcs | 10 | 420 |
| 140-0460-1420-0900 | 900 mm | Parlak / Bright | 1 Adet / 1 Pcs | 10 | 420 |

140-0480 • BAR MENFEZ • AIR VENTILATION COVER



Bilgi / Information

- Eni 120 mm
- Width 120 mm

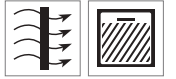

| Kod / Code No | Boy / Size | Renk / Colour | Birim / Unit |  |  |
|--------------------|------------|------------------------|----------------|---|---|
| 140-0480-1410-0423 | 423 mm | Eloksal / Mat Anodized | 1 Adet / 1 Pcs | 10 | 630 |
| 140-0480-1410-0610 | 610 mm | Eloksal / Mat Anodized | 1 Adet / 1 Pcs | 10 | 420 |
| 140-0480-1410-0900 | 900 mm | Eloksal / Mat Anodized | 1 Adet / 1 Pcs | 10 | 420 |
| 140-0480-1420-0423 | 423 mm | Parlak / Bright | 1 Adet / 1 Pcs | 10 | 630 |
| 140-0480-1420-0610 | 610 mm | Parlak / Bright | 1 Adet / 1 Pcs | 10 | 420 |
| 140-0480-1420-0900 | 900 mm | Parlak / Bright | 1 Adet / 1 Pcs | 10 | 420 |



Ventil Aluminium

ALÜMİNYUM DEKORATİF MENFEZ • ALUMINIUM AIR VENTILATION COVER

albaturas.com

Ventil Aluminium

ALÜMİNYUM DEKORATİF MENFEZ • ALUMINIUM AIR VENTILATION COVER

140-0900 • KOZA MENFEZ • AIR VENTILATION COVER

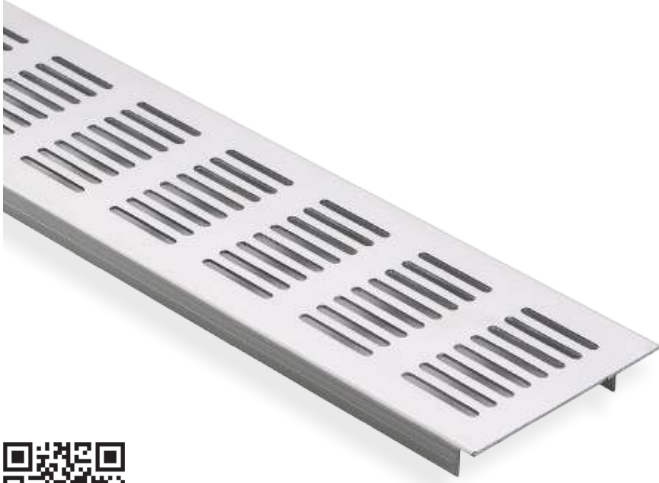

Bilgi / Information

- Eni 70 mm
- Birim adet fiyatlandır.
- Pakette 2 adet mevcuttur.

- Width 70 mm
- Unit prices.
- 2 Pcs in a bag.



| Kod / Code No | Boy / Size | Renk / Colour | Birim / Unit | | |
|--------------------|------------|------------------------|----------------|----|-------|
| 140-0900-1410-0200 | 200 mm | Eloksal / Mat Anodized | 1 Adet / 1 Pcs | 20 | 3.000 |
| 140-0900-1410-0270 | 270 mm | Eloksal / Mat Anodized | 1 Adet / 1 Pcs | 20 | 2.000 |
| 140-0900-1410-0423 | 423 mm | Eloksal / Mat Anodized | 1 Adet / 1 Pcs | 20 | 1.200 |
| 140-0900-1410-0500 | 500 mm | Eloksal / Mat Anodized | 1 Adet / 1 Pcs | 20 | 1.200 |
| 140-0900-1410-0610 | 610 mm | Eloksal / Mat Anodized | 1 Adet / 1 Pcs | 20 | 800 |
| 140-0900-1410-0763 | 763 mm | Eloksal / Mat Anodized | 1 Adet / 1 Pcs | 20 | 500 |
| 140-0900-1420-0270 | 270 mm | Parlak / Bright | 1 Adet / 1 Pcs | 20 | 2.000 |
| 140-0900-1420-0423 | 423 mm | Parlak / Bright | 1 Adet / 1 Pcs | 20 | 1.200 |
| 140-0900-1420-0500 | 500 mm | Parlak / Bright | 1 Adet / 1 Pcs | 20 | 1.200 |
| 140-0900-1420-0610 | 610 mm | Parlak / Bright | 1 Adet / 1 Pcs | 20 | 800 |

140-0700 • KOZA MENFEZ • AIR VENTILATION COVER

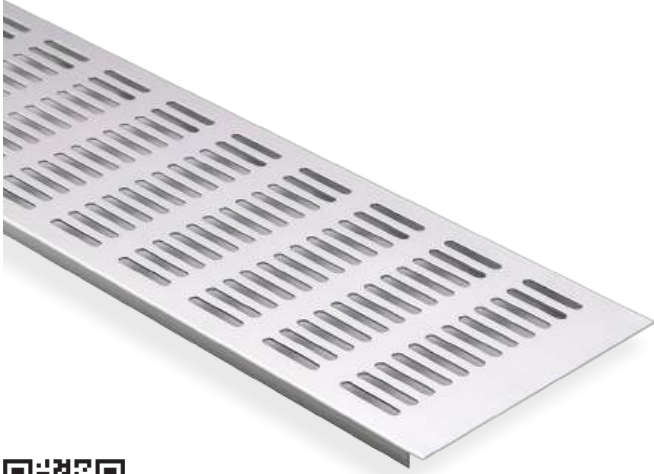

Bilgi / Information

- Eni 120 mm
- Birim adet fiyatlandır.
- Pakette 2 adet mevcuttur.

- Width 120 mm
- Unit prices.
- 2 Pcs in a bag.



| Kod / Code No | Boy / Size | Renk / Colour | Birim / Unit | | |
|--------------------|------------|------------------------|----------------|----|-------|
| 140-0700-1410-0200 | 200 mm | Eloksal / Mat Anodized | 1 Adet / 1 Pcs | 20 | 2.500 |
| 140-0700-1410-0270 | 270 mm | Eloksal / Mat Anodized | 1 Adet / 1 Pcs | 20 | 2.000 |
| 140-0700-1410-0423 | 423 mm | Eloksal / Mat Anodized | 1 Adet / 1 Pcs | 20 | 800 |
| 140-0700-1410-0500 | 500 mm | Eloksal / Mat Anodized | 1 Adet / 1 Pcs | 20 | 800 |
| 140-0700-1410-0610 | 610 mm | Eloksal / Mat Anodized | 1 Adet / 1 Pcs | 20 | 800 |
| 140-0700-1410-0763 | 763 mm | Eloksal / Mat Anodized | 1 Adet / 1 Pcs | 20 | 600 |
| 140-0700-1420-0270 | 270 mm | Parlak / Bright | 1 Adet / 1 Pcs | 20 | 2.000 |
| 140-0700-1420-0423 | 423 mm | Parlak / Bright | 1 Adet / 1 Pcs | 20 | 800 |
| 140-0700-1420-0500 | 500 mm | Parlak / Bright | 1 Adet / 1 Pcs | 20 | 800 |
| 140-0700-1420-0610 | 610 mm | Parlak / Bright | 1 Adet / 1 Pcs | 20 | 800 |

140-0750 • KOZA MENFEZ • AIR VENTILATION COVER



Bilgi / Information

- Eni 200 mm
- Birim adet fiyatlandır.
- Pakette 2 adet mevcuttur.

- Width 200 mm
- Unit prices.
- 2 Pcs in a bag.



| Kod / Code No | Boy / Size | Renk / Colour | Birim / Unit | | |
|--------------------|------------|------------------------|----------------|----|-----|
| 140-0750-1410-0270 | 270 mm | Eloksal / Mat Anodized | 1 Adet / 1 Pcs | 10 | 800 |
| 140-0750-1410-0423 | 423 mm | Eloksal / Mat Anodized | 1 Adet / 1 Pcs | 10 | 600 |
| 140-0750-1410-0500 | 500 mm | Eloksal / Mat Anodized | 1 Adet / 1 Pcs | 10 | 600 |
| 140-0750-1410-0610 | 610 mm | Eloksal / Mat Anodized | 1 Adet / 1 Pcs | 10 | 400 |
| 140-0750-1410-0763 | 763 mm | Eloksal / Mat Anodized | 1 Adet / 1 Pcs | 10 | 250 |
| 140-0750-1410-1000 | 1000 mm | Eloksal / Mat Anodized | 1 Adet / 1 Pcs | 4 | 120 |
| 140-0750-1410-2000 | 2000 mm | Eloksal / Mat Anodized | 1 Adet / 1 Pcs | 4 | 120 |

Ventil Aluminium

ALÜMİNYUM DEKORATİF MENFEZ • ALUMINIUM AIR VENTILATION COVER

140-0950 • KARE MENFEZ • AIR VENTILATION COVER





Bilgi / Information

- Eni 70 mm
- Birim adet fiyatlandır.
- Pakette 2 adet mevcuttur.

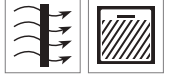
- Width 70 mm
- Unit prices.
- 2 Pcs in a bag.



| Kod / Code No | Boy / Size | Renk / Colour | Birim / Unit |  |  |
|--------------------|------------|------------------------|----------------|---|---|
| 140-0950-1410-0200 | 200 mm | Eloksal / Mat Anodized | 1 Adet / 1 Pcs | 20 | 3.000 |
| 140-0950-1410-0270 | 270 mm | Eloksal / Mat Anodized | 1 Adet / 1 Pcs | 20 | 2.000 |
| 140-0950-1410-0423 | 423 mm | Eloksal / Mat Anodized | 1 Adet / 1 Pcs | 20 | 1.200 |
| 140-0950-1410-0500 | 500 mm | Eloksal / Mat Anodized | 1 Adet / 1 Pcs | 20 | 1.200 |
| 140-0950-1410-0610 | 610 mm | Eloksal / Mat Anodized | 1 Adet / 1 Pcs | 20 | 800 |
| 140-0950-1410-0763 | 763 mm | Eloksal / Mat Anodized | 1 Adet / 1 Pcs | 20 | 500 |

140-0800 • KARE MENFEZ • AIR VENTILATION COVER

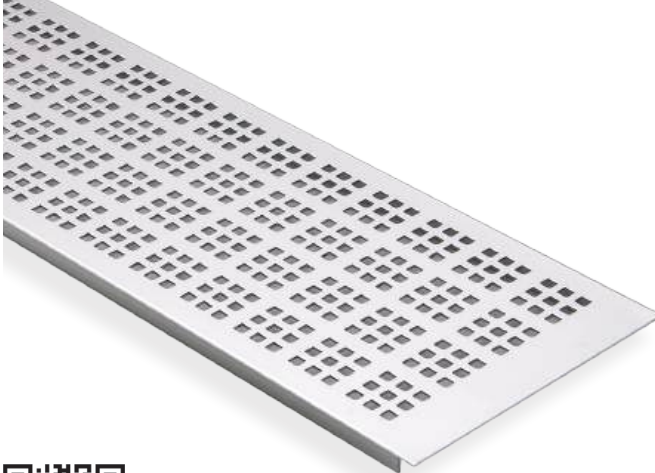

Bilgi / Information

- Eni 120 mm
- Birim adet fiyatlandır.
- Pakette 2 adet mevcuttur.

- Width 120 mm
- Unit prices.
- 2 Pcs in a bag.



| Kod / Code No | Boy / Size | Renk / Colour | Birim / Unit |  |  |
|--------------------|------------|------------------------|----------------|---|---|
| 140-0800-1410-0200 | 200 mm | Eloksal / Mat Anodized | 1 Adet / 1 Pcs | 20 | 2.500 |
| 140-0800-1410-0270 | 270 mm | Eloksal / Mat Anodized | 1 Adet / 1 Pcs | 20 | 2.000 |
| 140-0800-1410-0423 | 423 mm | Eloksal / Mat Anodized | 1 Adet / 1 Pcs | 20 | 800 |
| 140-0800-1410-0500 | 500 mm | Eloksal / Mat Anodized | 1 Adet / 1 Pcs | 20 | 800 |
| 140-0800-1410-0610 | 610 mm | Eloksal / Mat Anodized | 1 Adet / 1 Pcs | 20 | 800 |
| 140-0800-1410-0763 | 763 mm | Eloksal / Mat Anodized | 1 Adet / 1 Pcs | 20 | 600 |

140-0850 • KARE MENFEZ • AIR VENTILATION COVER



Bilgi / Information

- Eni 200 mm
- Birim adet fiyatlandır.
- Pakette 2 adet mevcuttur.

- Width 200 mm
- Unit prices.
- 2 Pcs in a bag.



| Kod / Code No | Boy / Size | Renk / Colour | Birim / Unit |  |  |
|--------------------|------------|------------------------|----------------|---|---|
| 140-0850-1410-0270 | 270 mm | Eloksal / Mat Anodized | 1 Adet / 1 Pcs | 10 | 800 |
| 140-0850-1410-0423 | 423 mm | Eloksal / Mat Anodized | 1 Adet / 1 Pcs | 10 | 600 |
| 140-0850-1410-0500 | 500 mm | Eloksal / Mat Anodized | 1 Adet / 1 Pcs | 10 | 600 |
| 140-0850-1410-0610 | 610 mm | Eloksal / Mat Anodized | 1 Adet / 1 Pcs | 10 | 400 |
| 140-0850-1410-0763 | 763 mm | Eloksal / Mat Anodized | 1 Adet / 1 Pcs | 10 | 250 |

Group 141

Ventil® Plastic

Plastik Dekoratif Menfez Serisi

Plastic Air Ventilation Cover Series



Bu serideki tüm ürünleri incelemek için QR kodu okutabilirsiniz.

You can search the QR code to see all the products in these series.

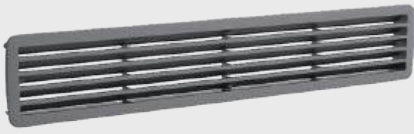

141-0680

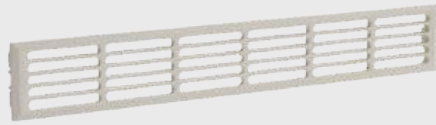

141-0650

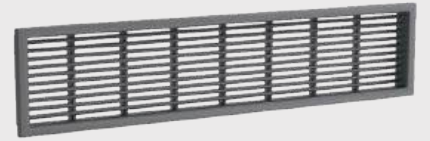

141-0630

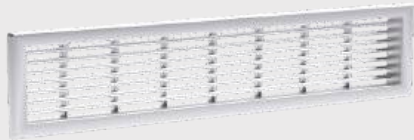

141-0640



141-0670

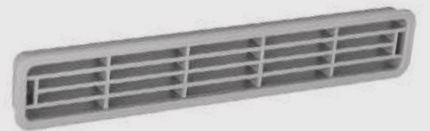

141-0600



141-0620



141-0625



141-0660



141-0610

Ventil 0680

PLASTİK • PLASTIC • 76 x 430 mm

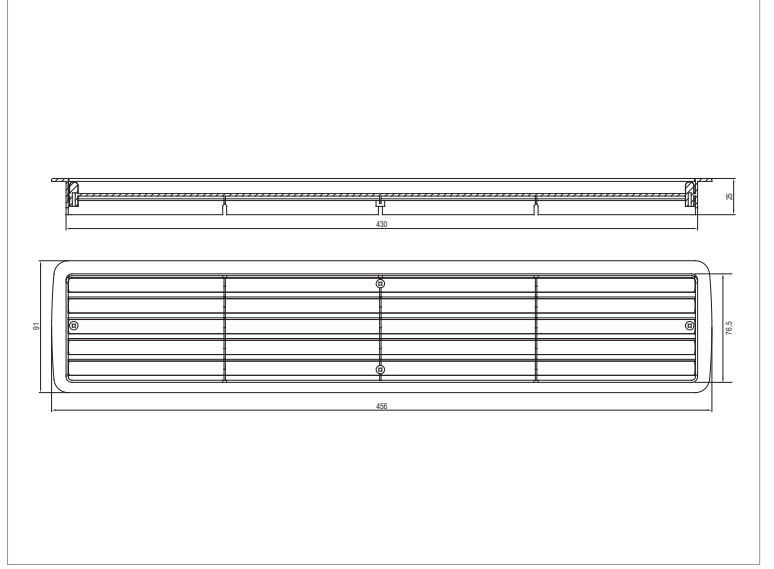

| Kod / Code No | Renk / Colour | Br. / Unit |  |  |
|---------------|-------------------|----------------|---|---|
| 141-0680-1700 | M.Gri / M.Grey | 1 Adet / 1 Pcs | 10 | 280 |
| 141-0680-1650 | Beyaz / White | 1 Adet / 1 Pcs | 10 | 280 |
| 141-0680-1670 | K.Kahve / D.Brown | 1 Adet / 1 Pcs | 10 | 280 |
| 141-0680-1600 | Gri / Grey | 1 Adet / 1 Pcs | 10 | 280 |
| 141-0680-1680 | Akçaağaç / Oak | 1 Adet / 1 Pcs | 10 | 280 |

Bilgi / Information

- Birim adet fiyatlandırılır. • Unit prices.
- Pakette 2 adet mevcuttur. • 2 Pcs in a bag.

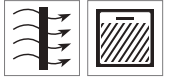

Ventil 0650

PLASTİK • PLASTIC • 70 x 466 mm

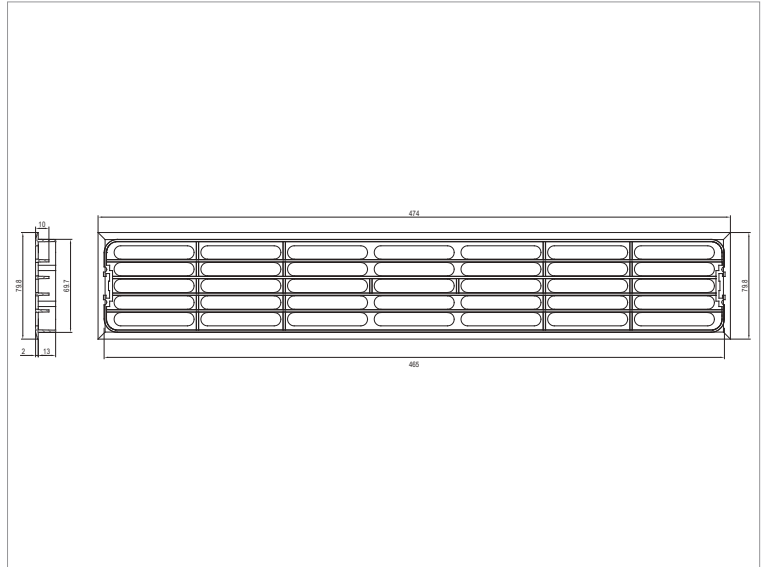

| Kod / Code No | Renk / Colour | Br. / Unit |  |  |
|---------------|-------------------|----------------|---|---|
| 141-0650-1700 | M.Gri / M.Grey | 1 Adet / 1 Pcs | 14 | 400 |
| 141-0650-1650 | Beyaz / White | 1 Adet / 1 Pcs | 14 | 400 |
| 141-0650-1670 | K.Kahve / D.Brown | 1 Adet / 1 Pcs | 14 | 400 |
| 141-0650-1630 | Siyah / Black | 1 Adet / 1 Pcs | 14 | 400 |

Bilgi / Information

- Birim adet fiyatlandırılır. • Unit prices.
- Pakette 2 adet mevcuttur. • 2 Pcs in a bag.



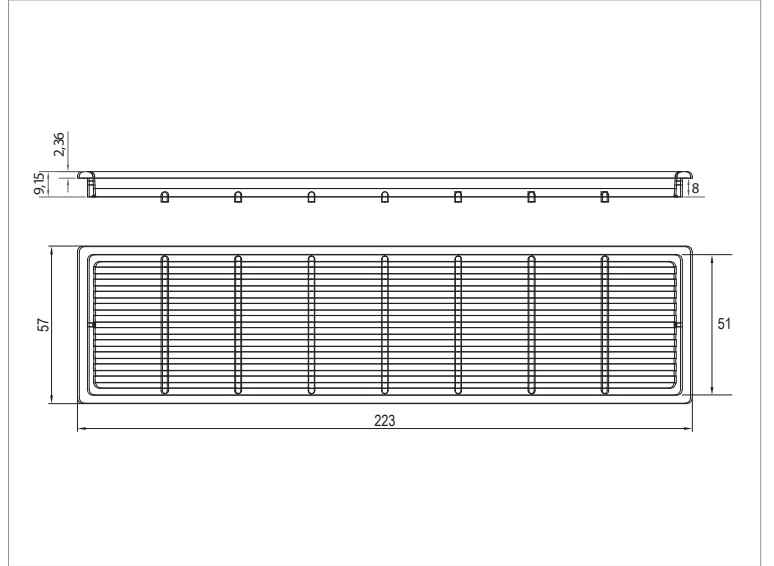

Ventil 0630

PLASTİK • PLASTIC • 51 x 215 mm



Bilgi / Information

- Birim adet fiyatlandırır.
- Unit Prices

| Kod / Code No | Renk / Colour | Br. / Unit |  |  |
|---------------|-----------------------|----------------|---|---|
| 141-0630-1800 | Krom / Chrome | 1 Adet / 1 Pcs | 50 | 2.000 |
| 141-0630-1810 | Mat Krom / Mat Chrome | 1 Adet / 1 Pcs | 50 | 2.000 |



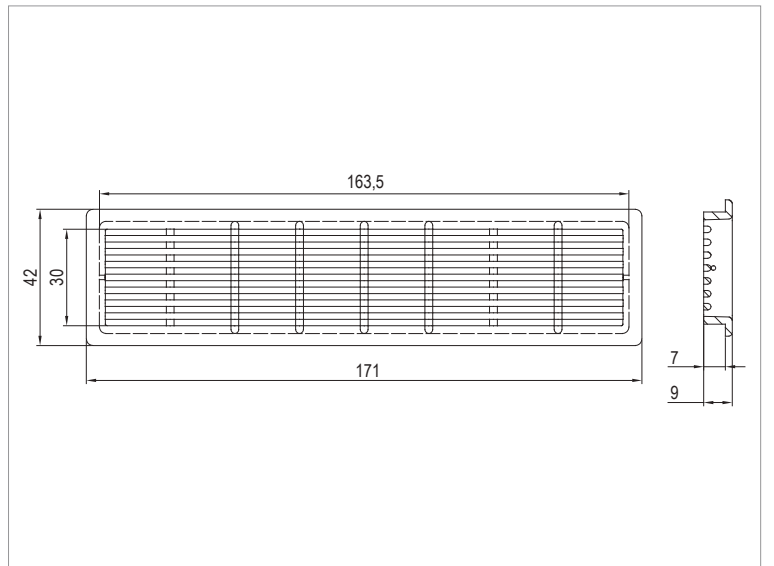
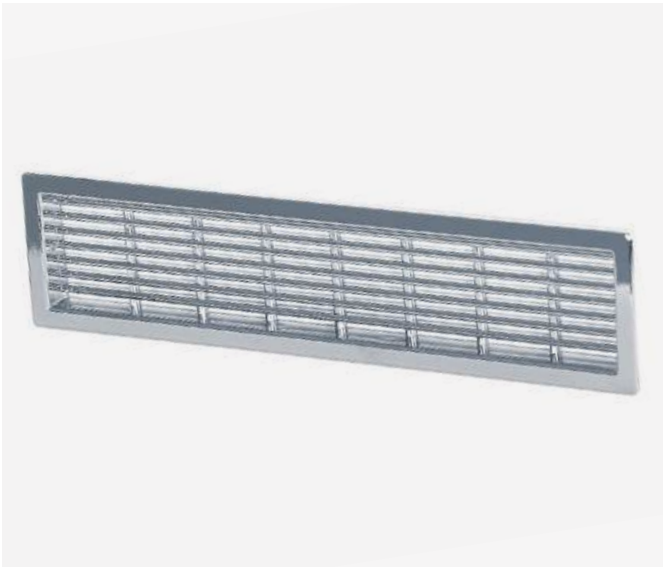

Ventil 0640

PLASTİK • PLASTIC • 35 x 164 mm



Bilgi / Information

- Birim adet fiyatlandırır.
- Unit Prices

| Kod / Code No | Renk / Colour | Br. / Unit |  |  |
|---------------|-----------------------|----------------|---|---|
| 141-0640-1800 | Krom / Chrome | 1 Adet / 1 Pcs | 50 | 2.000 |
| 141-0640-1810 | Mat Krom / Mat Chrome | 1 Adet / 1 Pcs | 50 | 2.000 |



Ventil 0670

PLASTİK • PLASTIC • 50 x 50 mm

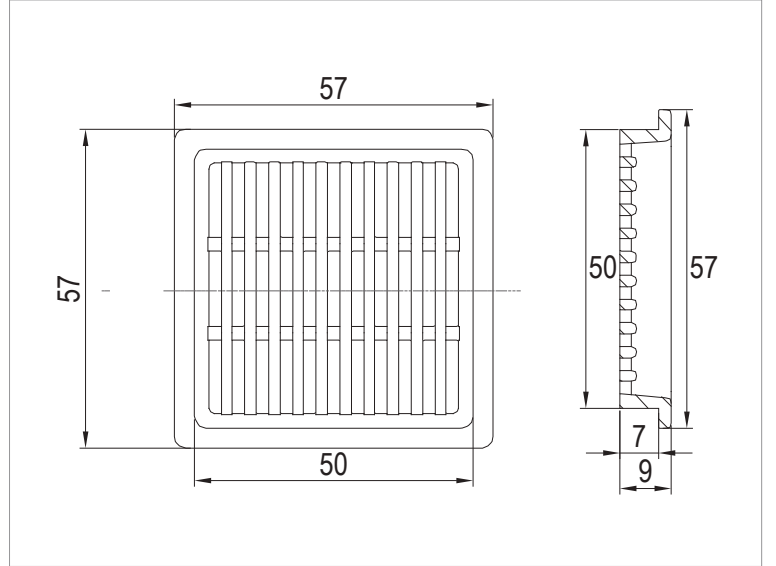

Bilgi / Information

- Birim adet fiyatlandırır.
- Unit Prices

| Kod / Code No | Renk / Colour | Br. / Unit | | |
|---------------|-----------------------|----------------|----|-------|
| 141-0670-1800 | Krom / Chrome | 1 Adet / 1 Pcs | 50 | 2.500 |
| 141-0670-1810 | Mat Krom / Mat Chrome | 1 Adet / 1 Pcs | 50 | 2.500 |

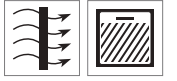

Ventil 0600

PLASTİK • PLASTIC • 200 x 30 mm

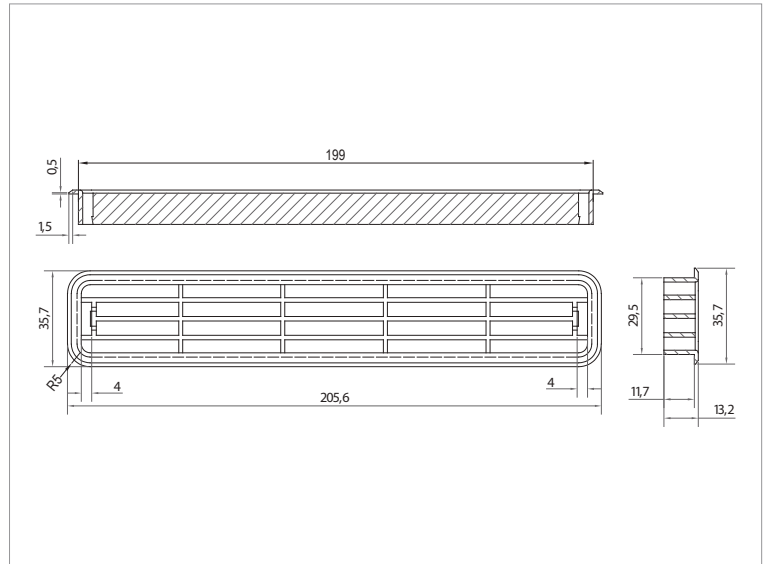

Bilgi / Information

- Birim adet fiyatlandırır.
- Unit Prices

| Kod / Code No | Renk / Colour | Br. / Unit | | |
|---------------|-------------------|----------------|-----|-------|
| 141-0600-1600 | M.Gri / M.Grey | 1 Adet / 1 Pcs | 100 | 6.000 |
| 141-0600-1660 | Krem / Cream | 1 Adet / 1 Pcs | 100 | 6.000 |
| 141-0600-1671 | Kahve / Brown | 1 Adet / 1 Pcs | 100 | 6.000 |
| 141-0600-1670 | K.Kahve / D.Brown | 1 Adet / 1 Pcs | 100 | 6.000 |
| 141-0600-1800 | Krom / Chrome | 1 Adet / 1 Pcs | 50 | 6.000 |
| 141-0600-1630 | Siyah / Black | 1 Adet / 1 Pcs | 100 | 6.000 |



Ventil 0620

PLASTİK • PLASTIC • Ø 34 mm

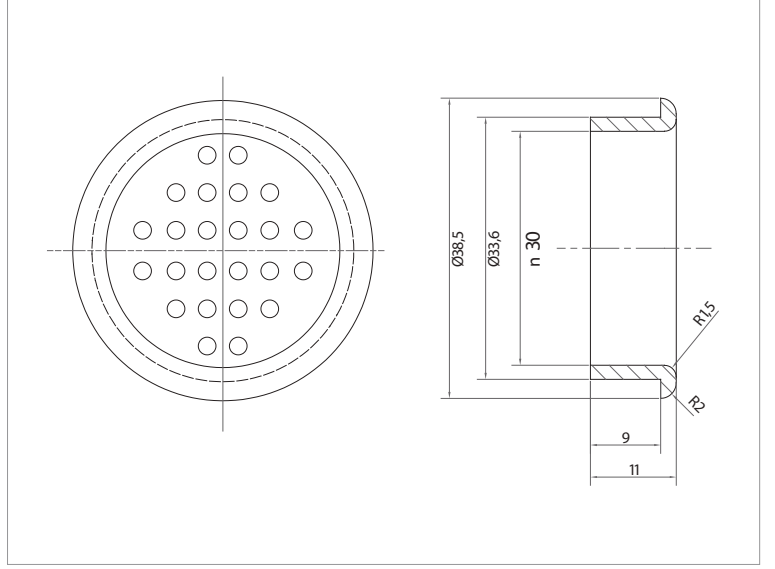

| Kod / Code No | Renk / Colour | Br. / Unit |  |  |
|---------------|-------------------|----------------|---|---|
| 141-0620-1650 | Beyaz / White | 1 Adet / 1 Pcs | 100 | 5.000 |
| 141-0620-1670 | K.Kahve / D.Brown | 1 Adet / 1 Pcs | 100 | 5.000 |
| 141-0620-1600 | Gri / Grey | 1 Adet / 1 Pcs | 100 | 5.000 |
| 141-0620-1800 | Krom / Chrome | 1 Adet / 1 Pcs | 100 | 5.000 |
| 141-0620-1630 | Siyah / Black | 1 Adet / 1 Pcs | 100 | 5.000 |

Bilgi / Information

- Birim adet fiyatlandırır.
- Unit Prices

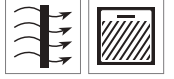

Ventil 0625

PLASTİK • PLASTIC • Ø 34 mm

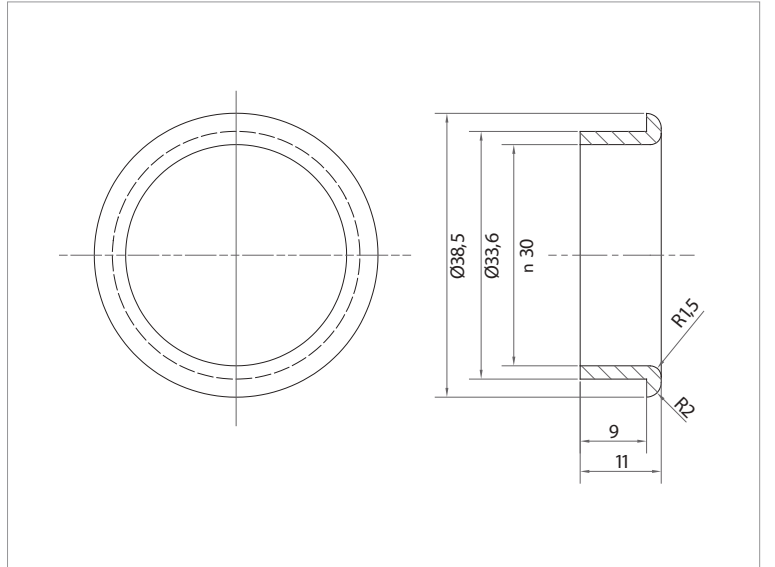

| Kod / Code No | Renk / Colour | Br. / Unit |  |  |
|---------------|-------------------|----------------|---|---|
| 141-0625-1650 | Beyaz / White | 1 Adet / 1 Pcs | 100 | 5.000 |
| 141-0625-1670 | K.Kahve / D.Brown | 1 Adet / 1 Pcs | 100 | 5.000 |
| 141-0625-1600 | Gri / Grey | 1 Adet / 1 Pcs | 100 | 5.000 |
| 141-0625-1800 | Krom / Chrome | 1 Adet / 1 Pcs | 100 | 5.000 |
| 141-0625-1630 | Siyah / Black | 1 Adet / 1 Pcs | 100 | 5.000 |

Bilgi / Information

- Birim adet fiyatlandırır.
- Unit Prices

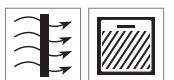

Ventil 0660

PLASTİK • PLASTIC • Ø 44 mm

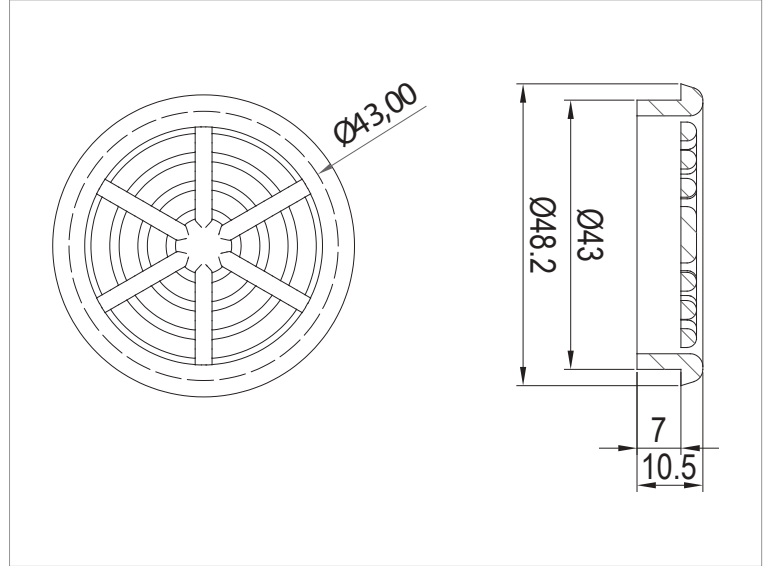

Bilgi / Information

- Birim adet fiyatlandırır.
- Unit Prices

| Kod / Code No | Renk / Colour | Br. / Unit |  |  |
|---------------|-------------------|----------------|---|---|
| 141-0660-1650 | Beyaz / White | 1 Adet / 1 Pcs | 100 | 5.000 |
| 141-0660-1670 | K.Kahve / D.Brown | 1 Adet / 1 Pcs | 100 | 5.000 |
| 141-0660-1600 | Gri / Grey | 1 Adet / 1 Pcs | 100 | 5.000 |
| 141-0660-1800 | Krom / Chrome | 1 Adet / 1 Pcs | 100 | 5.000 |

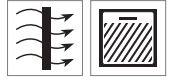

Ventil 0610

PLASTİK • PLASTIC • Ø 60 mm

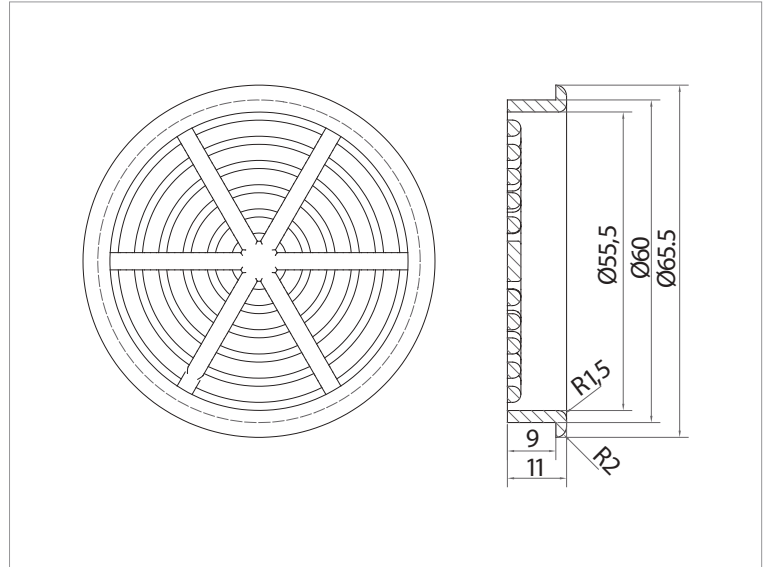

Bilgi / Information

- Birim adet fiyatlandırır.
- Unit Prices

| Kod / Code No | Renk / Colour | Br. / Unit |  |  |
|---------------|-------------------|----------------|---|---|
| 141-0610-1650 | Beyaz / White | 1 Adet / 1 Pcs | 100 | 4.000 |
| 141-0610-1670 | K.Kahve / D.Brown | 1 Adet / 1 Pcs | 100 | 4.000 |
| 141-0610-1600 | Gri / Grey | 1 Adet / 1 Pcs | 100 | 4.000 |
| 141-0610-1800 | Krom / Chrome | 1 Adet / 1 Pcs | 100 | 4.000 |

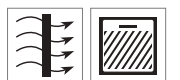



Ventil

DEKORATİF MENFEZ - AIR VENTILATION COVER

albaturas.com

Group 142

TurnTable®

Döner Tabla Mekanizma Serisi
Swivel Plate - Turnable Table Series



Bu serideki tüm ürünleri incelemek için
QR kodu okutabilirsiniz.

You can search the QR code to see all the
products in these series.

TurnTable

DÖNER TABLA MEKANİZMASI • SWIVEL PLATE - TURNABLE TABLE MECHANISM

Group **142**



TurnTable 60



TurnTable 61



TurnTable 62



TurnTable 65



TurnTable 67



TurnTable 68



TurnTable 70



TurnTable 75



TurnTable 81

TurnTable 60

DÖNER TABLA MEKANİZMASI • SWIVEL PLATE - TURNABLE TABLE MECHANISM



Teknik Detay / Technical Detail

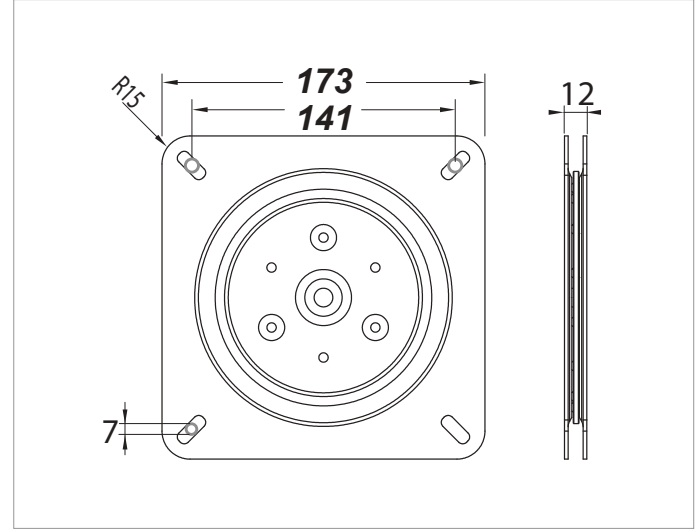

Ölçülerde değişiklik yapma hakkı saklıdır. Reserves the right to the change of the dimensions.



| Kod / Code No | Açıklama / Description | L/W mm | Renk / Colour | Birim / Unit | | |
|---------------|---|----------------------|-----------------------|----------------|----|-------|
| 142-0060-1300 | Döner Tabla Mekanizması / Swivel Plate - Turnable Table Mechanism | 173 x 173 mm H:12 mm | Galvaniz / Galvanized | 1 Adet / 1 Pcs | 10 | 1.280 |



Ölçülerde değişiklik yapma hakkı saklıdır. Reserves the right to the change of the dimensions.

TurnTable 61

DÖNER TABLA MEKANİZMASI • SWIVEL PLATE - TURNABLE TABLE MECHANISM



Teknik Detay / Technical Detail

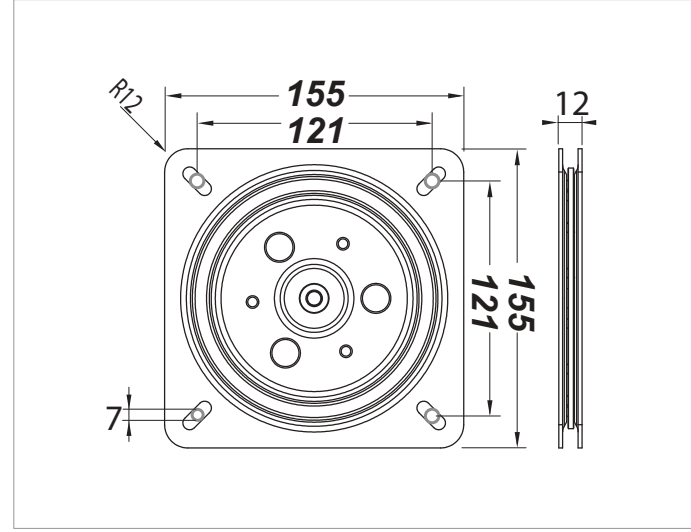

Ölçülerde değişiklik yapma hakkı saklıdır. Reserves the right to the change of the dimensions.

| Kod / Code No | Açıklama / Description | L/W mm | Renk / Colour | Birim / Unit | | |
|---------------|---|----------------------|---------------|----------------|----|-------|
| 142-0061-1220 | Döner Tabla Mekanizması / Swivel Plate - Turnable Table Mechanism | 155 x 155 mm H:12 mm | Siyah / Black | 1 Adet / 1 Pcs | 10 | 1.280 |

TurnTable 62

DÖNER TABLA MEKANİZMASI • SWIVEL PLATE - TURNABLE TABLE MECHANISM



Teknik Detay / Technical Detail

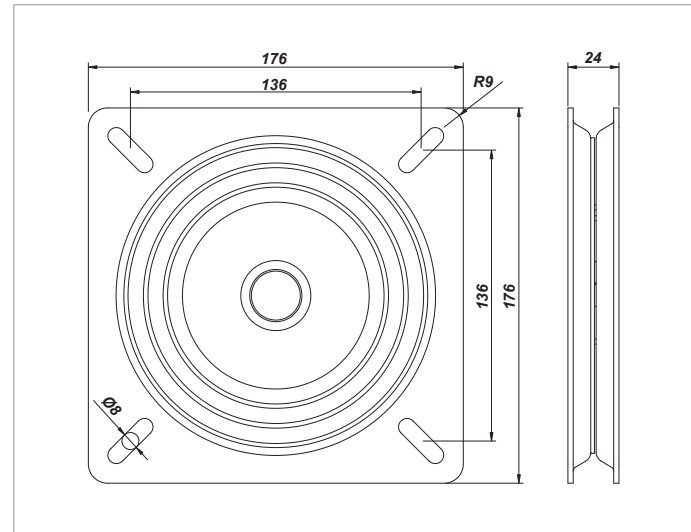

Ölçülerde değişiklik yapma hakkı saklıdır. Reserves the right to the change of the dimensions.

Bilgi / Information

- Ürünümüz ölçüsel olarak güncellenmiştir.
- Dimension of our product has been updated.

| Kod / Code No | Açıklama / Description | L/W mm | Renk / Colour | Birim / Unit | | |
|---------------|---|----------------------|---------------|----------------|---|-----|
| 142-0062-1220 | Döner Tabla Mekanizması / Swivel Plate - Turnable Table Mechanism | 176 x 176 mm H:24 mm | Siyah / Black | 1 Adet / 1 Pcs | 5 | 640 |

TurnTable 65

DÖNER TABLA MEKANİZMASI • SWIVEL PLATE - TURNABLE TABLE MECHANISM



■ Teknik Detay / Technical Detail

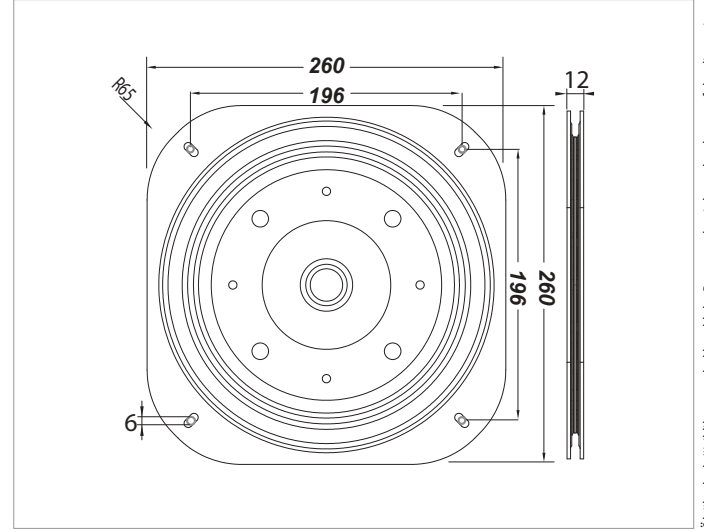

Ölçülerde değişiklik yapma hakkı saklıdır. Reserves the right to the change of the dimensions.

| Kod / Code No | Açıklama / Description | L/W mm | Renk / Colour | Birim / Unit | | |
|---------------|---|----------------------|-----------------------|----------------|----|-----|
| 142-0065-1300 | Döner Tabla Mekanizması / Swivel Plate - Turnable Table Mechanism | 260 x 260 mm H:12 mm | Galvaniz / Galvanized | 1 Adet / 1 Pcs | 10 | 800 |

TurnTable 67

DÖNER TABLA MEKANİZMASI • SWIVEL PLATE - TURNABLE TABLE MECHANISM



■ Teknik Detay / Technical Detail

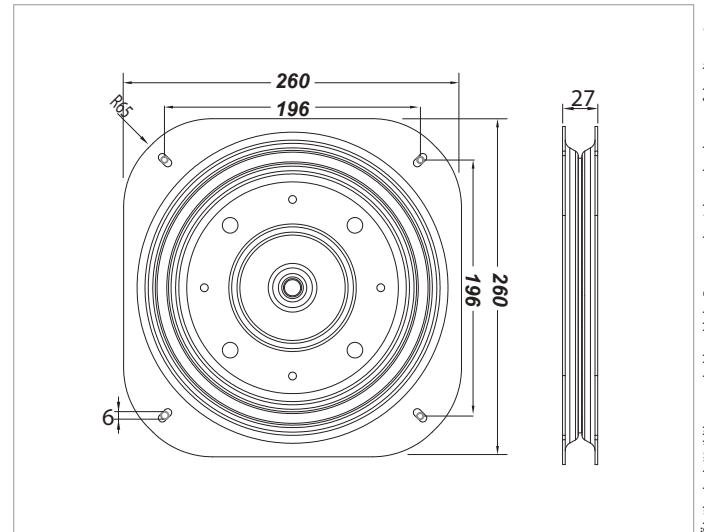

Ölçülerde değişiklik yapma hakkı saklıdır. Reserves the right to the change of the dimensions.

| Kod / Code No | Açıklama / Description | L/W mm | Renk / Colour | Birim / Unit | | |
|---------------|---|----------------------|-----------------------|----------------|---|-----|
| 142-0067-1300 | Döner Tabla Mekanizması / Swivel Plate - Turnable Table Mechanism | 260 x 260 mm H:27 mm | Galvaniz / Galvanized | 1 Adet / 1 Pcs | 5 | 400 |

TurnTable 68

DÖNER TABLA MEKANİZMASI • SWIVEL PLATE - TURNABLE TABLE MECHANISM



■ Teknik Detay / Technical Detail

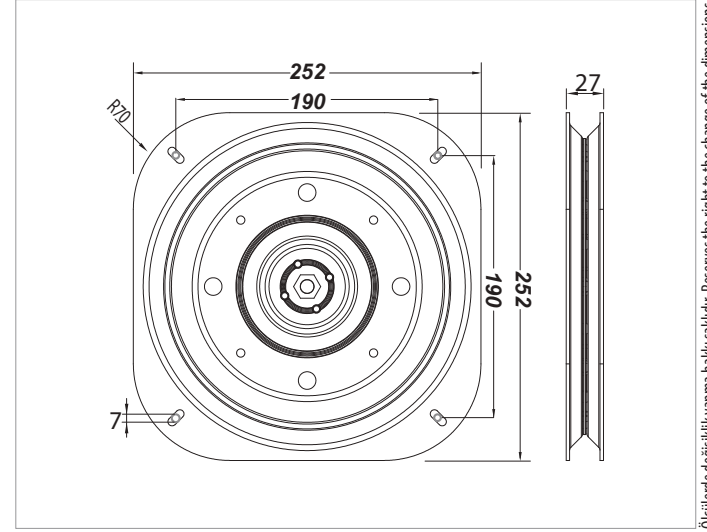

Ölçülerde değişiklik yapma hakkı saklıdır. Reserves the right to the change of the dimensions.

| Kod / Code No | Açıklama / Description | L/W mm | Renk / Colour | Birim / Unit | | |
|---------------|---|----------------------|---------------|----------------|---|-----|
| 142-0068-1220 | Döner Tabla Mekanizması / Swivel Plate - Turnable Table Mechanism | 252 x 252 mm H:27 mm | Siyah / Black | 1 Adet / 1 Pcs | 5 | 240 |

TurnTable 70

KONUM SABİTLEYİCİ • SWIVEL LOCATION STABILIZER



■ Teknik Detay / Technical Detail

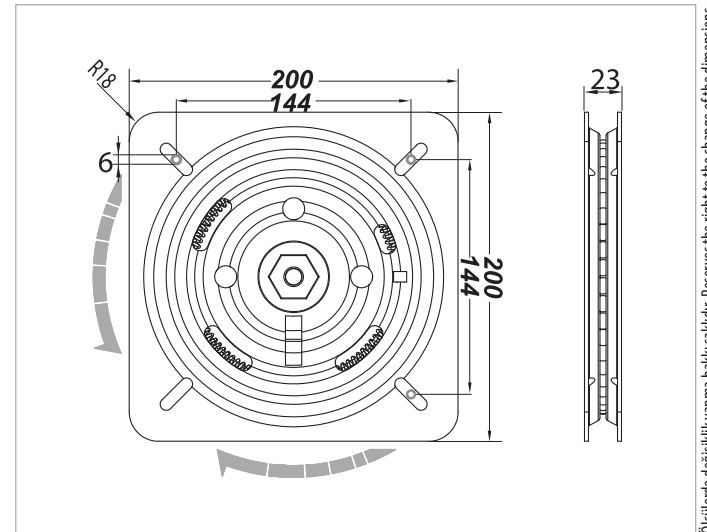

Ölçülerde değişiklik yapma hakkı saklıdır. Reserves the right to the change of the dimensions.

| Kod / Code No | Açıklama / Description | L/W mm | Renk / Colour | Birim / Unit | | |
|---------------|--|----------------------|---------------|----------------|---|-----|
| 142-0070-1220 | Konum Sabitleyici / Swivel Location Stabilizer | 200 x 200 mm H:23 mm | Siyah / Black | 1 Adet / 1 Pcs | 6 | 288 |

TurnTable 75

DÖNER TABLA MEKANİZMASI • SWIVEL PLATE - TURNABLE TABLE MECHANISM



Teknik Detay / Technical Detail

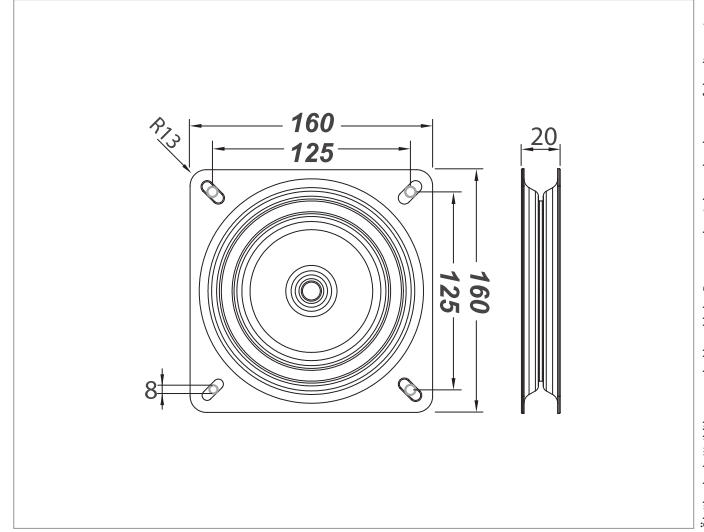

Ölçülerde değişiklik yapma hakkı saklıdır. Reserves the right to the change of the dimensions.

| Kod / Code No | Açıklama / Description | L/W mm | Renk / Colour | Birim / Unit | | |
|---------------|---|----------------------|---------------|----------------|---|-----|
| 142-0075-1220 | Döner Tabla Mekanizması / Swivel Plate - Turnable Table Mechanism | 160 x 160 mm H:20 mm | Siyah / Black | 1 Adet / 1 Pcs | 5 | 480 |

TurnTable 81

KONUM SABİTLEYİCİ • SWIVEL LOCATION STABILIZER



Teknik Detay / Technical Detail

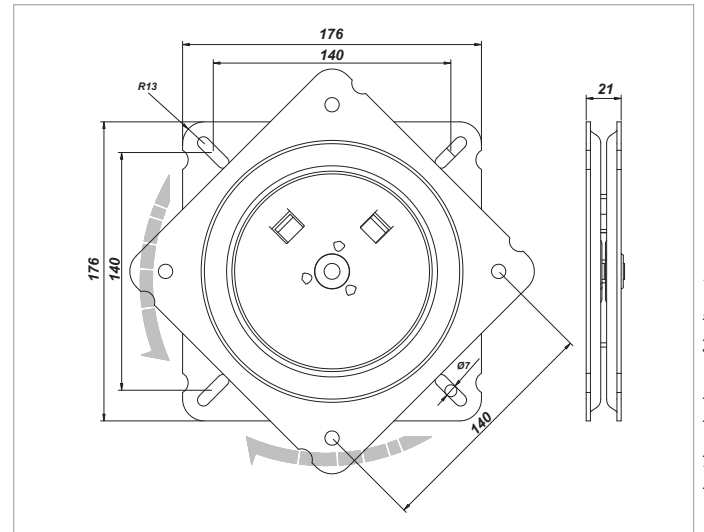

Ölçülerde değişiklik yapma hakkı saklıdır. Reserves the right to the change of the dimensions.

| Kod / Code No | Açıklama / Description | L/W mm | Renk / Colour | Birim / Unit | | |
|---------------|--|----------------------|-----------------------|----------------|---|-----|
| 142-0081-1300 | Konum Sabitleyici / Swivel Location Stabilizer | 176 x 176 mm H:21 mm | Galvaniz / Galvanized | 1 Adet / 1 Pcs | 5 | 640 |

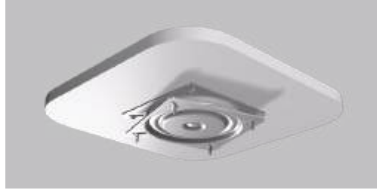

TurnTable Series

DÖNER TABLA MEKANİZMASI • SWIVEL PLATE - TURNABLE TABLE MECHANISM

Group 143

Master+

Mobilya Aksesuarları
Furniture Accessories



Bu serideki tüm ürünleri incelemek için QR kodu okutabilirsiniz.

You can search the QR code to see all the products in these series.



151-0001

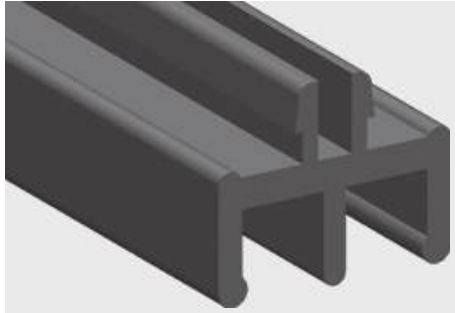

151-0002



143-1328-001



143-1328-002

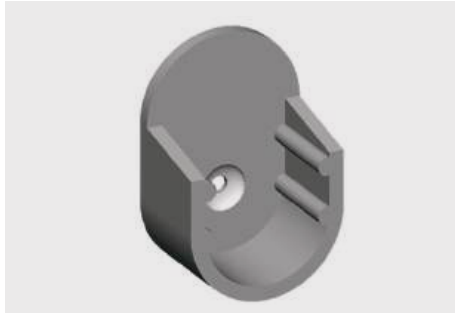

143-2413

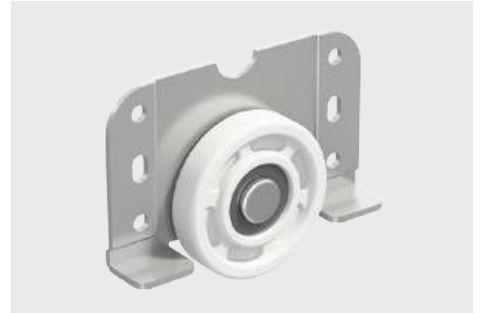

143-7056



143-1000



143-1010



143-1020



143-1030



143-1040



143-1050



143-1060



143-1070

PVC Profil

PVC PROFILE

151-0001

ALT PVC PROFİL • BOTTOM PVC PROFILE



■ Teknik Detay / Technical Detail

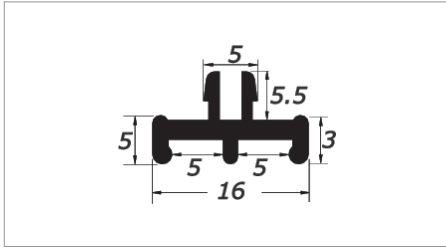

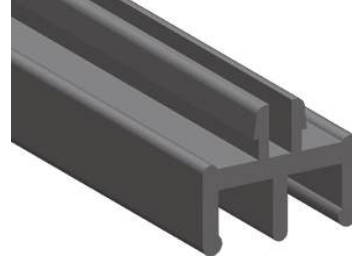

151-0002

ÜST PVC PROFİL • Top PVC PROFILE

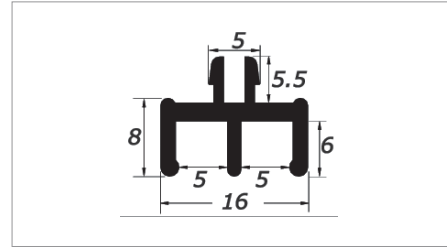

■ Teknik Detay / Technical Detail



| Kod / Code No | Açıklama / Description | L (mt) | Renk / Colour | Birim / Unit |  |  |
|--------------------|-------------------------------------|----------|---------------|----------------|---|---|
| 151-0001-1600-3000 | Alt PVC Profil / Bottom PVC Profile | 3,00 mt | Gri / Grey | 1 Adet / 1 Pcs | 50 | 50 |
| 151-0002-1600-3000 | Üst PVC Profil / Top PVC Profile | 3,00 mt | Gri / Grey | 1 Adet / 1 Pcs | 50 | 50 |

Tezgah Önü Tapası

BANCO RETURN TO PLUG

143-1328-001

TEZGAH ÖNÜ TAPASI • BANCO RETURN TO PLUG



■ Teknik Detay / Technical Detail

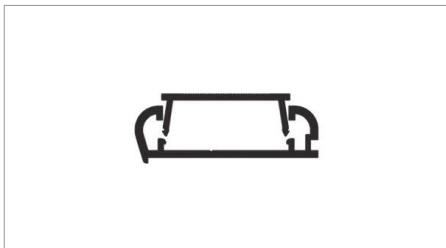



143-1328-002

TEZGAH ÖNÜ TAPASI • BANCO RETURN TO PLUG

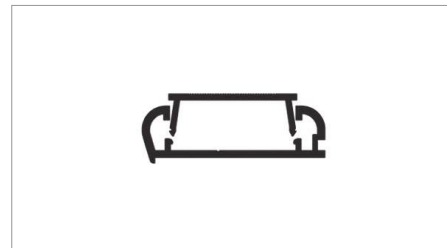

■ Teknik Detay / Technical Detail



| Kod / Code No | Açıklama / Description | Renk / Colour | Birim / Unit |  |  |
|---------------|--|-----------------|----------------|---|---|
| 143-1328-1700 | Tezgah Önü Tapası / Banco Return to Plug | Gri / Grey | 1 Adet / 1 Pcs | 20 | 1.920 |
| 143-1328-1800 | Tezgah Önü Tapası / Banco Return to Plug | Parlak / Bright | 1 Adet / 1 Pcs | 20 | 1.920 |

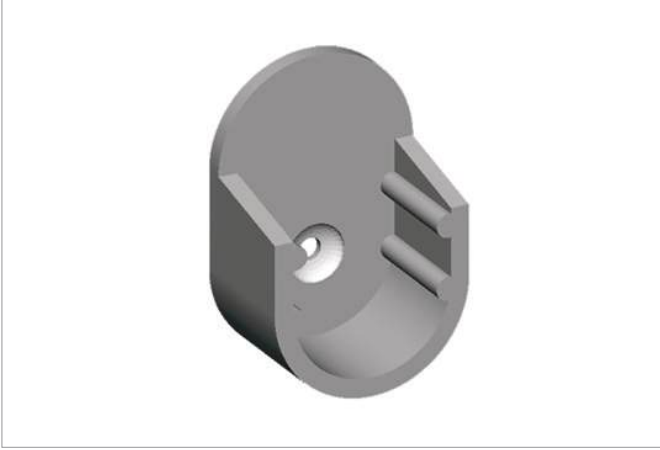

143-2413

PLASTİK ASKI BORU FLANŞI • HANGER PIPE FLANGE

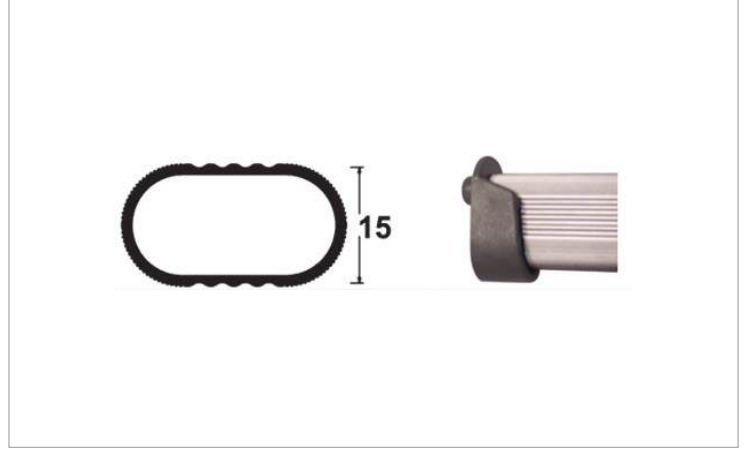

■ Teknik Detay / Technical Detail



| Kod / Code No | Açıklama / Description | Renk / Colour | Birim / Unit |  |  |
|---------------|---|---------------|----------------|--|--|
| 143-2413-1600 | Plastik Askı Boru Flanşı / Hanger Pipe Flange | Gri / Grey | 1 Adet / 1 Pcs | 200 | 19.200 |

143-7056

120 KG BAZA TAŞIYICI TEKER • BED BASE CARRIER ROLLER





■ Teknik Detay / Technical Detail



■ Bilgi / Information

- 1 takım 4 adet mekanizmadan oluşur.
- 1 set 4 pcs.



| Kod / Code No | Açıklama / Description | Renk / Colour | Birim / Unit |  |  |
|---------------|---|---------------|----------------|---|---|
| 143-7056-1200 | 120 Kg Baza Taşıyıcı Teker / Carrier Roller | Gri / Grey | 4 Adet / 1 Set | 24 | 768 |

143-1000

PANEL BİLEŞENİ • PANEL COMPONENT

link+

Yeni Ürün
New Product



Teknik Detay / Technical Detail

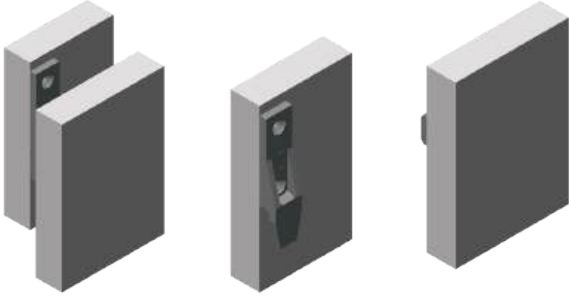
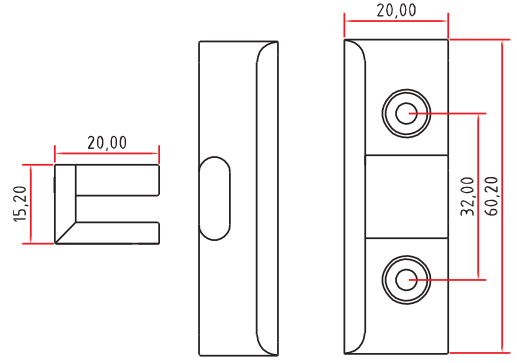

| Kod / Code No | Açıklama / Description | Renk / Colour | Birim / Unit | | |
|---------------|----------------------------------|---------------|----------------|-----|------|
| 143-1000-1630 | Panel Bileşeni / Panel Component | Siyah / Black | 1 Adet / 1 Pcs | 100 | 6000 |

143-1010

PANEL BİLEŞENİ • PANEL COMPONENT

link+

Yeni Ürün
New Product



Teknik Detay / Technical Detail

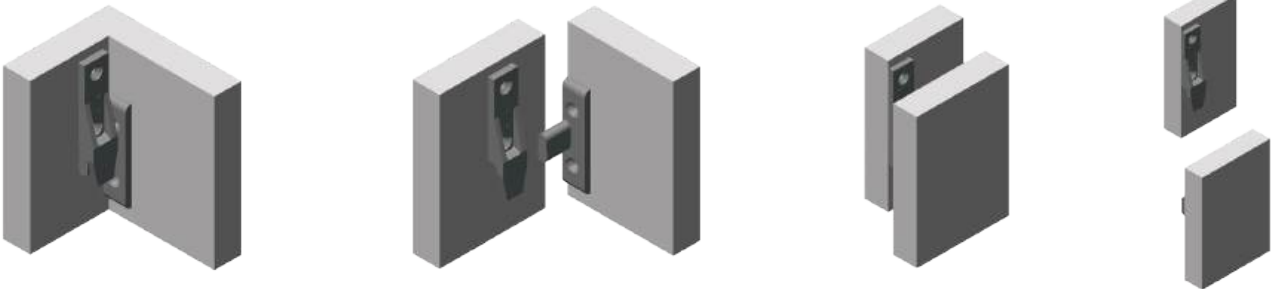
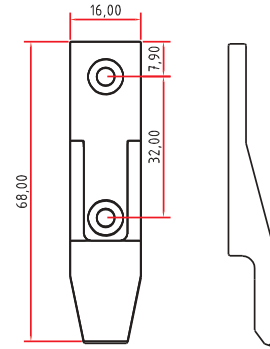

| Kod / Code No | Açıklama / Description | Renk / Colour | Birim / Unit | | |
|---------------|----------------------------------|---------------|----------------|-----|------|
| 143-1010-1630 | Panel Bileşeni / Panel Component | Siyah / Black | 1 Adet / 1 Pcs | 100 | 6000 |

143-1020

PANEL BİLEŞENİ • PANEL COMPONENT



YeniÜrün
NewProduct

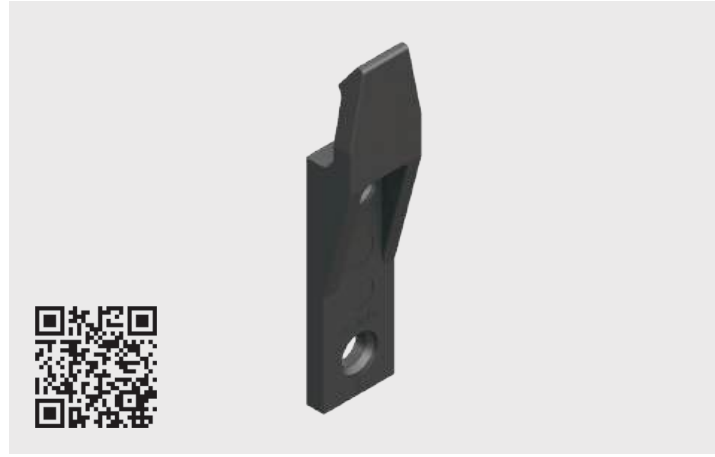

Teknik Detay / Technical Detail

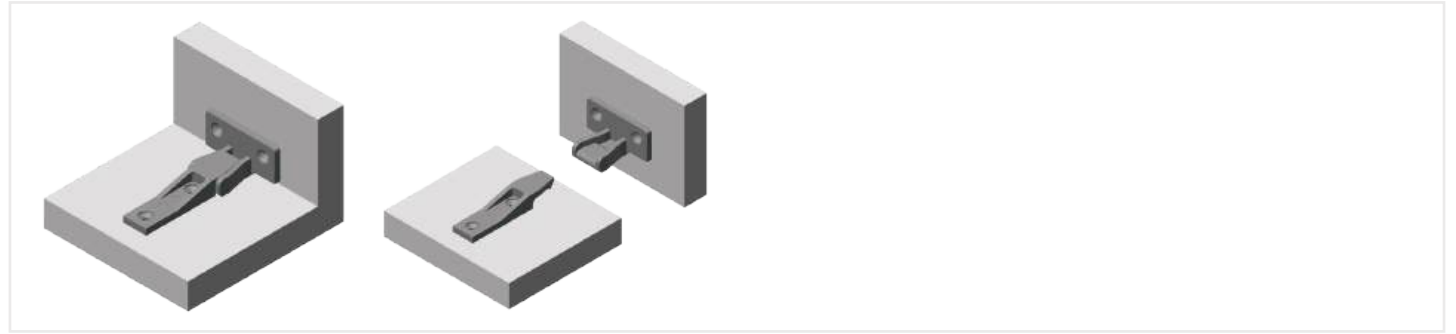
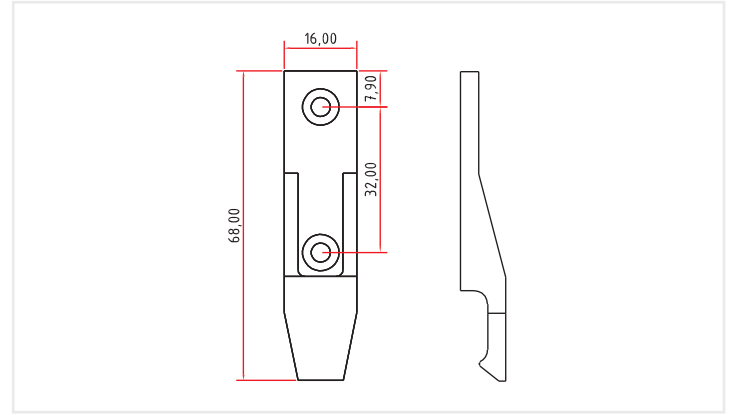

| Kod / Code No | Açıklama / Description | Renk / Colour | Birim / Unit | | |
|---------------|----------------------------------|---------------|----------------|-----|------|
| 143-1020-1630 | Panel Bileşeni / Panel Component | Siyah / Black | 1 Adet / 1 Pcs | 100 | 6000 |

143-1030

PANEL BİLEŞENİ • PANEL COMPONENT



YeniÜrün
NewProduct

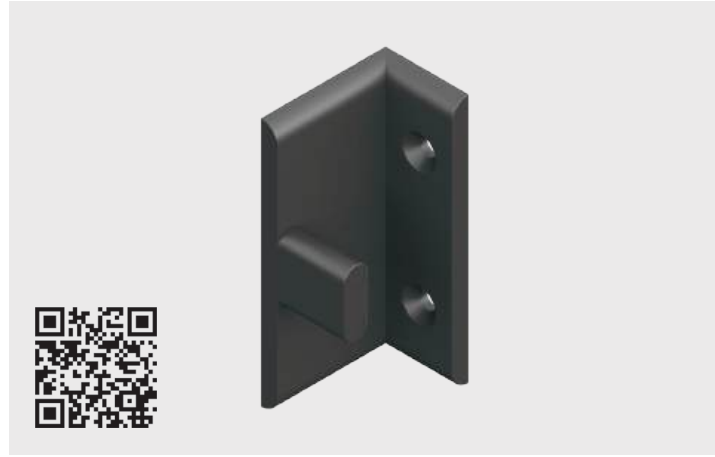

Teknik Detay / Technical Detail

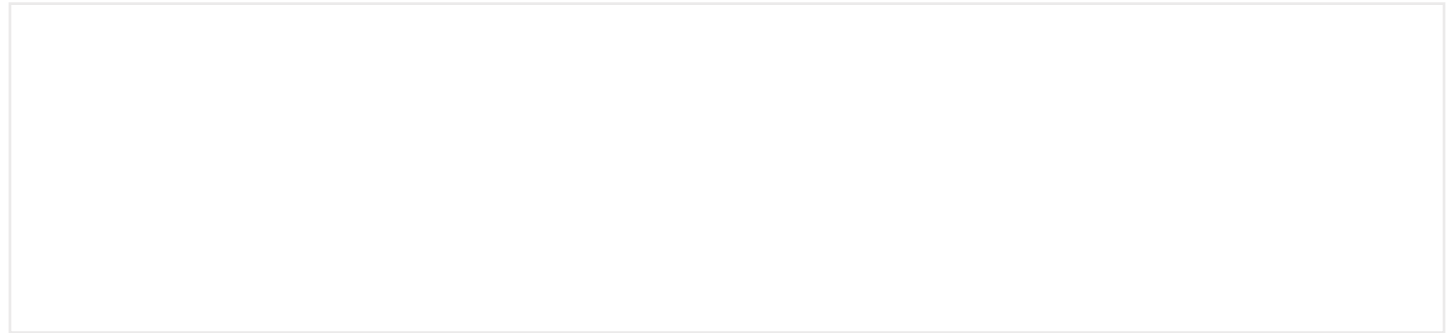
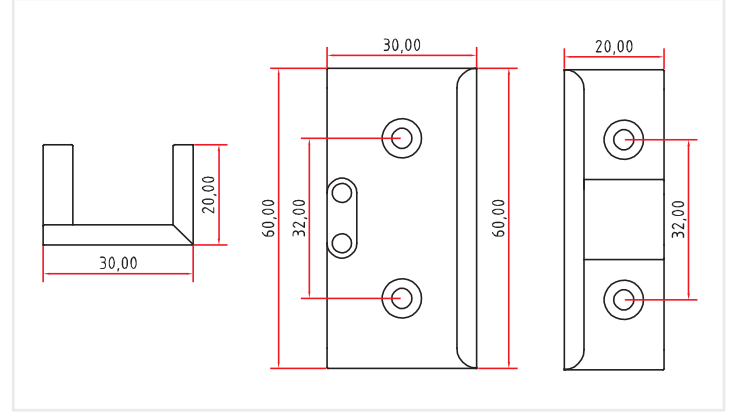

| Kod / Code No | Açıklama / Description | Renk / Colour | Birim / Unit | | |
|---------------|----------------------------------|---------------|----------------|-----|------|
| 143-1030-1630 | Panel Bileşeni / Panel Component | Siyah / Black | 1 Adet / 1 Pcs | 100 | 6000 |

143-1040

PANEL BİLEŞENİ • PANEL COMPONENT

link+

Yeni Ürün
New Product



Teknik Detay / Technical Detail

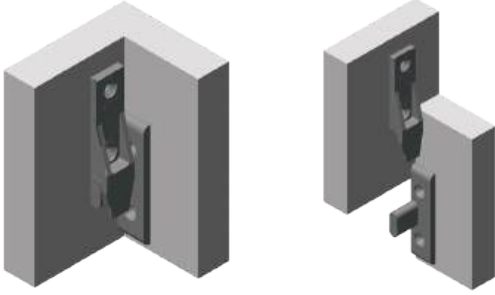
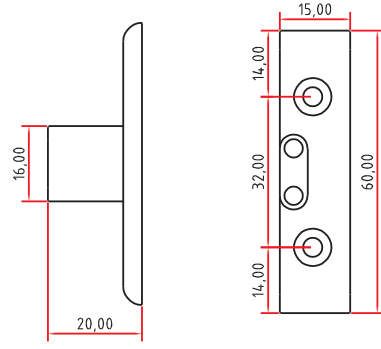

| Kod / Code No | Açıklama / Description | Renk / Colour | Birim / Unit | | |
|---------------|----------------------------------|---------------|----------------|-----|------|
| 143-1040-1630 | Panel Bileşeni / Panel Component | Siyah / Black | 1 Adet / 1 Pcs | 100 | 6000 |

143-1050

PANEL BİLEŞENİ • PANEL COMPONENT

link+

Yeni Ürün
New Product



Teknik Detay / Technical Detail

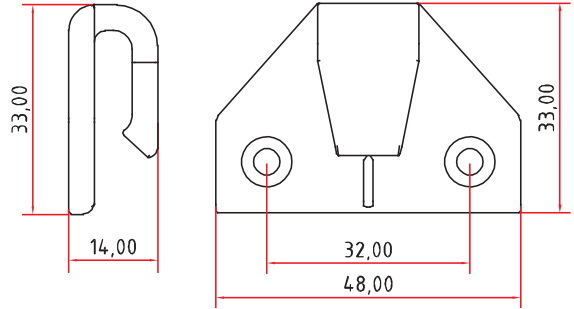

| Kod / Code No | Açıklama / Description | Renk / Colour | Birim / Unit | | |
|---------------|----------------------------------|---------------|----------------|-----|------|
| 143-1050-1630 | Panel Bileşeni / Panel Component | Siyah / Black | 1 Adet / 1 Pcs | 100 | 6000 |

143-1060

PANEL BİLEŞENİ • PANEL COMPONENT



Yeni Ürün
New Product

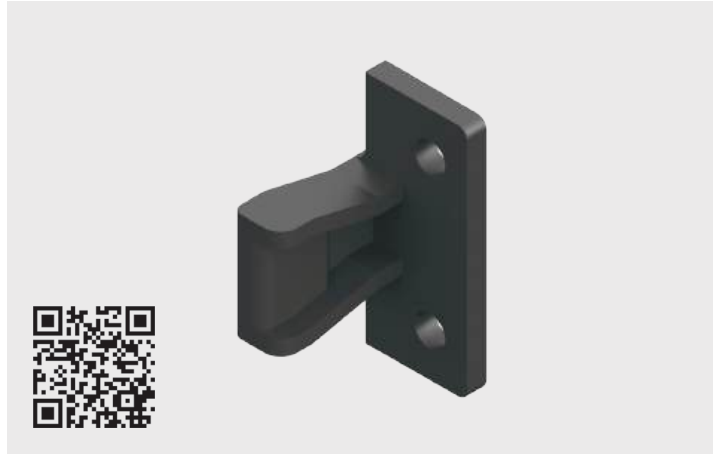

Teknik Detay / Technical Detail

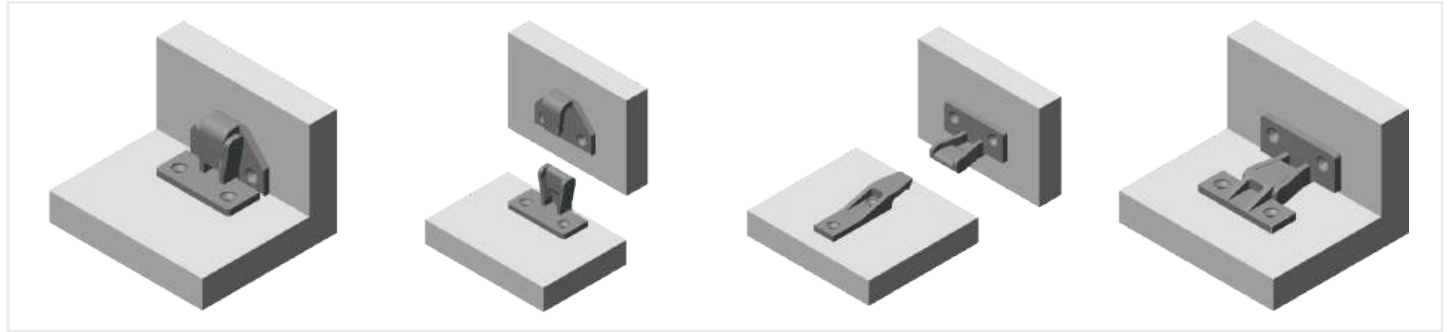
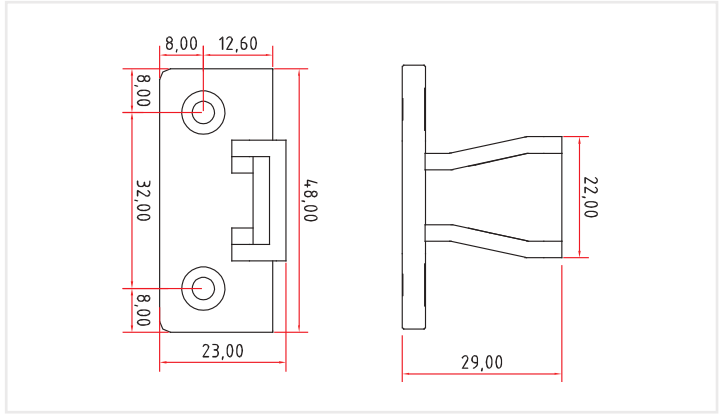

| Kod / Code No | Açıklama / Description | Renk / Colour | Birim / Unit | | |
|---------------|----------------------------------|---------------|----------------|-----|------|
| 143-1060-1630 | Panel Bileşeni / Panel Component | Siyah / Black | 1 Adet / 1 Pcs | 100 | 6000 |

143-1070

PANEL BİLEŞENİ • PANEL COMPONENT



Yeni Ürün
New Product



Teknik Detay / Technical Detail

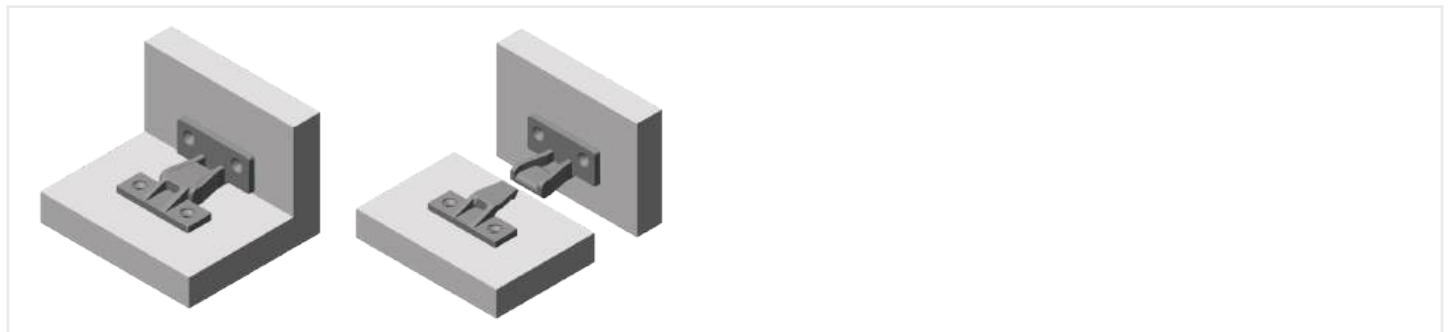
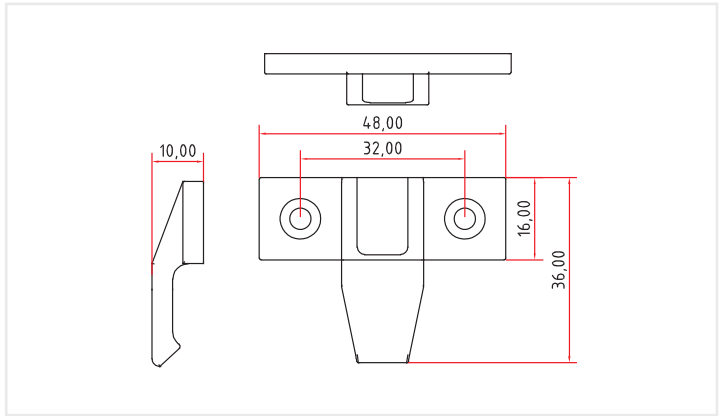

| Kod / Code No | Açıklama / Description | Renk / Colour | Birim / Unit | | |
|---------------|----------------------------------|---------------|----------------|-----|------|
| 143-1070-1630 | Panel Bileşeni / Panel Component | Siyah / Black | 1 Adet / 1 Pcs | 100 | 6000 |

Group 144

Feet

Koltuk ve Baza Ayakları Serisi
Furniture Feet Series



Bu serideki tüm ürünleri incelemek için QR kodu okutabilirsiniz.

You can search the QR code to see all the products in these series.

Feet

KOLTUK VE BAZA AYAKLARI • FURNITURE FEET

Group **144**



Feet **0001**



Feet **0129**



Feet **0115**



Feet **0120**



Feet **0121**



Feet **0127**



Feet **0131**



Feet **0123**



Feet **0124**



Feet **0125**



Feet **0126**



Feet **0132**



Feet **0147**

Feet

KOLTUK VE BAZA AYAKLARI SERİSİ • FURNITURE FEET SERIES

Özel Üretim
Special Production

144-0001 • ALÜMİNYUM TELESKOPİK STAND • ALUMINIUM TELESCOPIC STAND

Bilgi / Information

- * Siparişe özel Minimum 2000 adet üretilmektedir.
- * Koli içeriği 9 adettir.
- * Lütfen teklif isteyiniz.
- * Produced minimum 2.000 pcs for special order.
- * Content of the box 9 pieces.
- * Please ask to us for price offer.



| Kod / Code No | Açıklama / Description | Renk / Colour | Birim / Unit |  |  |
|---------------|--|------------------------|----------------|--|--|
| 144-0001-1410 | Alüminyum Çok Amaçlı Stand / Aluminium Teleskopik Stands | Eloksal / Mat Anodized | 1 Adet / 1 Pcs | 6 | 72 |



■ 144-0129 • AYARLI BAZA MEKANİZMASI • FURNITURE FEET



| Kod / Code No | Renk / Colour | H (cm) | Birim / Unit | | |
|--------------------|-----------------------|--------|----------------|----|-------|
| 144-0129-1300-0060 | Galvaniz / Galvanized | 6 cm | 1 Adet / 1 Pcs | 50 | 1.600 |
| 144-0129-1300-0080 | Galvaniz / Galvanized | 8 cm | 1 Adet / 1 Pcs | 50 | 1.600 |
| 144-0129-1300-0100 | Galvaniz / Galvanized | 10 cm | 1 Adet / 1 Pcs | 50 | 1.600 |
| 144-0129-1300-0120 | Galvaniz / Galvanized | 12 cm | 1 Adet / 1 Pcs | 50 | 1.600 |

■ 144-0115 • ALÜMİNYUM SUNTA DESTEK AYAK • ALUMINIUM FURNITURE FEET • W 25 x 25 mm



| Kod / Code No | Renk / Colour | H (cm) | Birim / Unit | | |
|--------------------|------------------------|--------|----------------|-----|-------|
| 144-0115-1410-0050 | Eloksal / Mat Anodized | 5 cm | 1 Adet / 1 Pcs | 100 | 3.200 |
| 144-0115-1410-0060 | Eloksal / Mat Anodized | 6 cm | 1 Adet / 1 Pcs | 100 | 3.200 |
| 144-0115-1410-0080 | Eloksal / Mat Anodized | 8 cm | 1 Adet / 1 Pcs | 100 | 2.400 |
| 144-0115-1410-0100 | Eloksal / Mat Anodized | 10 cm | 1 Adet / 1 Pcs | 100 | 2.400 |
| 144-0115-1410-0120 | Eloksal / Mat Anodized | 12 cm | 1 Adet / 1 Pcs | 100 | 1.800 |
| 144-0115-1410-0150 | Eloksal / Mat Anodized | 15 cm | 1 Adet / 1 Pcs | 100 | 1.800 |
| 144-0115-1410-0200 | Eloksal / Mat Anodized | 20 cm | 1 Adet / 1 Pcs | 80 | 1.440 |

■ 144-0120 • ALÜMİNYUM BAZA KÖŞE AYAK • ALUMINIUM FURNITURE FEET • W 25 x 25 mm



| Kod / Code No | Renk / Colour | H (cm) | Birim / Unit | | |
|--------------------|------------------------|--------|----------------|-----|-------|
| 144-0120-1410-0060 | Eloksal / Mat Anodized | 6 cm | 1 Adet / 1 Pcs | 100 | 3.200 |
| 144-0120-1410-0080 | Eloksal / Mat Anodized | 8 cm | 1 Adet / 1 Pcs | 100 | 2.400 |
| 144-0120-1410-0100 | Eloksal / Mat Anodized | 10 cm | 1 Adet / 1 Pcs | 100 | 2.400 |
| 144-0120-1410-0120 | Eloksal / Mat Anodized | 12 cm | 1 Adet / 1 Pcs | 100 | 1.800 |
| 144-0120-1410-0150 | Eloksal / Mat Anodized | 15 cm | 1 Adet / 1 Pcs | 60 | 1.080 |
| 144-0120-1410-0200 | Eloksal / Mat Anodized | 20 cm | 1 Adet / 1 Pcs | 60 | 1.080 |
| 144-0120-1410-0220 | Eloksal / Mat Anodized | 22 cm | 1 Adet / 1 Pcs | 60 | 1.080 |
| 144-0120-1410-0250 | Eloksal / Mat Anodized | 25 cm | 1 Adet / 1 Pcs | 60 | 1.080 |

■ 144-0121 • ALÜMİNYUM BAZA ORTA AYAK • ALUMINIUM FURNITURE FEET • W 25 x 25 mm



| Kod / Code No | Renk / Colour | H (cm) | Birim / Unit | | |
|--------------------|------------------------|--------|----------------|----|-------|
| 144-0121-1410-0060 | Eloksal / Mat Anodized | 6 cm | 1 Adet / 1 Pcs | 50 | 1.600 |
| 144-0121-1410-0080 | Eloksal / Mat Anodized | 8 cm | 1 Adet / 1 Pcs | 50 | 1.600 |
| 144-0121-1410-0100 | Eloksal / Mat Anodized | 10 cm | 1 Adet / 1 Pcs | 50 | 1.200 |
| 144-0121-1410-0120 | Eloksal / Mat Anodized | 12 cm | 1 Adet / 1 Pcs | 50 | 1.200 |
| 144-0121-1410-0150 | Eloksal / Mat Anodized | 15 cm | 1 Adet / 1 Pcs | 50 | 900 |
| 144-0121-1410-0200 | Eloksal / Mat Anodized | 20 cm | 1 Adet / 1 Pcs | 50 | 900 |
| 144-0121-1410-0220 | Eloksal / Mat Anodized | 22 cm | 1 Adet / 1 Pcs | 50 | 900 |
| 144-0121-1410-0250 | Eloksal / Mat Anodized | 25 cm | 1 Adet / 1 Pcs | 50 | 900 |

■ 144-0127 • ALÜMİNYUM BAZA AYAK • ALUMINIUM FURNITURE FEET • Ø 30 mm



| Kod / Code No | Renk / Colour | H (cm) | Birim / Unit | | |
|--------------------|------------------------|--------|----------------|-----|-------|
| 144-0127-1410-0060 | Eloksal / Mat Anodized | 6 cm | 1 Adet / 1 Pcs | 100 | 3.200 |
| 144-0127-1410-0080 | Eloksal / Mat Anodized | 8 cm | 1 Adet / 1 Pcs | 100 | 2.400 |
| 144-0127-1410-0100 | Eloksal / Mat Anodized | 10 cm | 1 Adet / 1 Pcs | 100 | 2.400 |
| 144-0127-1410-0120 | Eloksal / Mat Anodized | 12 cm | 1 Adet / 1 Pcs | 100 | 1.800 |
| 144-0127-1410-0150 | Eloksal / Mat Anodized | 15 cm | 1 Adet / 1 Pcs | 100 | 1.800 |
| 144-0127-1410-0200 | Eloksal / Mat Anodized | 20 cm | 1 Adet / 1 Pcs | 50 | 900 |
| 144-0127-1410-0220 | Eloksal / Mat Anodized | 22 cm | 1 Adet / 1 Pcs | 50 | 900 |
| 144-0127-1410-0250 | Eloksal / Mat Anodized | 25 cm | 1 Adet / 1 Pcs | 50 | 900 |

■ 144-0131 • ALÜMİNYUM BAZA AYAK • ALUMINIUM FURNITURE FEET
W 38 x 38 mm

| Kod / Code No | Renk / Colour | H (cm) | Birim / Unit | | |
|--------------------|------------------------|--------|----------------|-----|-------|
| 144-0131-1410-0050 | Eloksal / Mat Anodized | 5 cm | 1 Adet / 1 Pcs | 100 | 1.800 |
| 144-0131-1410-0060 | Eloksal / Mat Anodized | 6 cm | 1 Adet / 1 Pcs | 100 | 1.800 |
| 144-0131-1410-0080 | Eloksal / Mat Anodized | 8 cm | 1 Adet / 1 Pcs | 100 | 1.800 |
| 144-0131-1410-0100 | Eloksal / Mat Anodized | 10 cm | 1 Adet / 1 Pcs | 100 | 1.800 |
| 144-0131-1410-0120 | Eloksal / Mat Anodized | 12 cm | 1 Adet / 1 Pcs | 100 | 1.800 |
| 144-0131-1410-0150 | Eloksal / Mat Anodized | 15 cm | 1 Adet / 1 Pcs | 50 | 900 |
| 144-0131-1410-0200 | Eloksal / Mat Anodized | 20 cm | 1 Adet / 1 Pcs | 50 | 900 |
| 144-0131-1410-0220 | Eloksal / Mat Anodized | 22 cm | 1 Adet / 1 Pcs | 50 | 900 |
| 144-0131-1410-0250 | Eloksal / Mat Anodized | 25 cm | 1 Adet / 1 Pcs | 50 | 900 |

■ 144-0123 • ALÜMİNYUM BAZA AYAK • ALUMINIUM FURNITURE FEET • W 25 x 25 mm



| Kod / Code No | Renk / Colour | H (cm) | Birim / Unit | | |
|--------------------|------------------------|--------|----------------|----|-------|
| 144-0123-1410-0060 | Eloksal / Mat Anodized | 6 cm | 1 Adet / 1 Pcs | 50 | 1.600 |
| 144-0123-1410-0080 | Eloksal / Mat Anodized | 8 cm | 1 Adet / 1 Pcs | 50 | 1.600 |
| 144-0123-1410-0100 | Eloksal / Mat Anodized | 10 cm | 1 Adet / 1 Pcs | 50 | 1.600 |
| 144-0123-1410-0120 | Eloksal / Mat Anodized | 12 cm | 1 Adet / 1 Pcs | 50 | 1.200 |
| 144-0123-1410-0150 | Eloksal / Mat Anodized | 15 cm | 1 Adet / 1 Pcs | 50 | 1.200 |
| 144-0123-1410-0200 | Eloksal / Mat Anodized | 20 cm | 1 Adet / 1 Pcs | 50 | 1.200 |

■ 144-0124 • ALÜMİNYUM ORTA AYAK • ALUMINIUM FURNITURE FEET • W 25 x 25 mm



| Kod / Code No | Renk / Colour | H (cm) | Birim / Unit | | |
|--------------------|------------------------|--------|----------------|----|-------|
| 144-0124-1410-0060 | Eloksal / Mat Anodized | 6 cm | 1 Adet / 1 Pcs | 50 | 1.600 |
| 144-0124-1410-0080 | Eloksal / Mat Anodized | 8 cm | 1 Adet / 1 Pcs | 50 | 1.600 |
| 144-0124-1410-0100 | Eloksal / Mat Anodized | 10 cm | 1 Adet / 1 Pcs | 50 | 1.600 |
| 144-0124-1410-0120 | Eloksal / Mat Anodized | 12 cm | 1 Adet / 1 Pcs | 50 | 1.200 |
| 144-0124-1410-0150 | Eloksal / Mat Anodized | 15 cm | 1 Adet / 1 Pcs | 50 | 1.200 |
| 144-0124-1410-0200 | Eloksal / Mat Anodized | 20 cm | 1 Adet / 1 Pcs | 50 | 1.200 |

■ 144-0125 • ALÜMİNYUM AYARLI BAZA AYAK • FURNITURE FEET • Ø 30 mm



| Kod / Code No | Renk / Colour | H (cm) | Birim / Unit |  |  |
|--------------------|------------------------|--------|----------------|---|---|
| 144-0125-1410-0060 | Eloksal / Mat Anodized | 6 cm | 1 Adet / 1 Pcs | 50 | 1.600 |
| 144-0125-1410-0080 | Eloksal / Mat Anodized | 8 cm | 1 Adet / 1 Pcs | 50 | 1.600 |
| 144-0125-1410-0100 | Eloksal / Mat Anodized | 10 cm | 1 Adet / 1 Pcs | 50 | 1.600 |
| 144-0125-1410-0120 | Eloksal / Mat Anodized | 12 cm | 1 Adet / 1 Pcs | 50 | 1.200 |
| 144-0125-1410-0150 | Eloksal / Mat Anodized | 15 cm | 1 Adet / 1 Pcs | 50 | 1.200 |
| 144-0125-1410-0200 | Eloksal / Mat Anodized | 20 cm | 1 Adet / 1 Pcs | 50 | 1.200 |

■ 144-0126 • ALÜMİNYUM AYARLI BAZA ORTA AYAK • FURNITURE FEET • Ø 30 mm



| Kod / Code No | Renk / Colour | H (cm) | Birim / Unit |  |  |
|--------------------|------------------------|--------|----------------|---|---|
| 144-0126-1410-0060 | Eloksal / Mat Anodized | 6 cm | 1 Adet / 1 Pcs | 50 | 1.600 |
| 144-0126-1410-0080 | Eloksal / Mat Anodized | 8 cm | 1 Adet / 1 Pcs | 50 | 1.600 |
| 144-0126-1410-0100 | Eloksal / Mat Anodized | 10 cm | 1 Adet / 1 Pcs | 50 | 1.600 |
| 144-0126-1410-0120 | Eloksal / Mat Anodized | 12 cm | 1 Adet / 1 Pcs | 50 | 1.200 |
| 144-0126-1410-0150 | Eloksal / Mat Anodized | 15 cm | 1 Adet / 1 Pcs | 50 | 1.200 |
| 144-0126-1410-0200 | Eloksal / Mat Anodized | 20 cm | 1 Adet / 1 Pcs | 50 | 1.200 |

■ 144-0132 • ALÜMİNYUM BAZA AYAK • ALUMINIUM FURNITURE FEET • W 40 x 40 mm



| Kod / Code No | Renk / Colour | H (cm) | Birim / Unit |  |  |
|--------------------|------------------------|--------|----------------|---|---|
| 144-0132-1410-0060 | Eloksal / Mat Anodized | 6 cm | 1 Adet / 1 Pcs | 60 | 1.920 |
| 144-0132-1410-0080 | Eloksal / Mat Anodized | 8 cm | 1 Adet / 1 Pcs | 60 | 1.920 |
| 144-0132-1410-0100 | Eloksal / Mat Anodized | 10 cm | 1 Adet / 1 Pcs | 60 | 1.920 |
| 144-0132-1410-0120 | Eloksal / Mat Anodized | 12 cm | 1 Adet / 1 Pcs | 60 | 1.440 |
| 144-0132-1410-0150 | Eloksal / Mat Anodized | 15 cm | 1 Adet / 1 Pcs | 60 | 1.440 |
| 144-0132-1410-0200 | Eloksal / Mat Anodized | 20 cm | 1 Adet / 1 Pcs | 60 | 1.440 |

■ 144-0147 • ALÜMİNYUM BAZA AYAK • ALUMINIUM FURNITURE FEET • Ø 50 mm



| Kod / Code No | Renk / Colour | H (cm) | Birim / Unit |  |  |
|--------------------|------------------------|--------|----------------|---|---|
| 144-0147-1410-0060 | Eloksal / Mat Anodized | 6 cm | 1 Adet / 1 Pcs | 60 | 1.920 |
| 144-0147-1410-0080 | Eloksal / Mat Anodized | 8 cm | 1 Adet / 1 Pcs | 40 | 1.280 |
| 144-0147-1410-0100 | Eloksal / Mat Anodized | 10 cm | 1 Adet / 1 Pcs | 40 | 1.280 |
| 144-0147-1410-0120 | Eloksal / Mat Anodized | 12 cm | 1 Adet / 1 Pcs | 40 | 960 |
| 144-0147-1410-0150 | Eloksal / Mat Anodized | 15 cm | 1 Adet / 1 Pcs | 40 | 960 |
| 144-0147-1410-0200 | Eloksal / Mat Anodized | 20 cm | 1 Adet / 1 Pcs | 20 | 480 |

Group 150











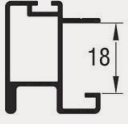
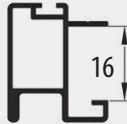
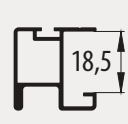
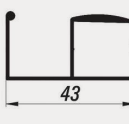
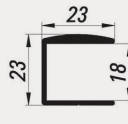
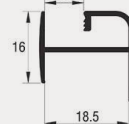
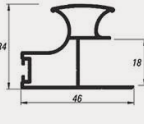
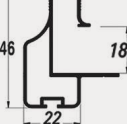
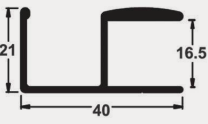
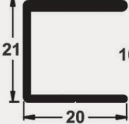
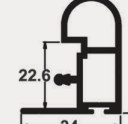
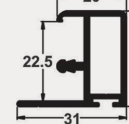
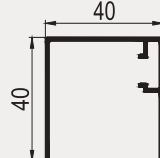
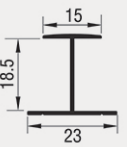
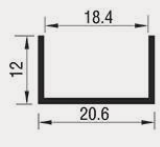

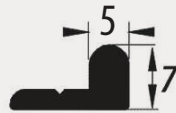
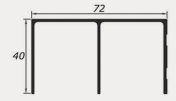
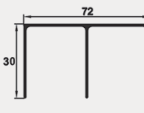
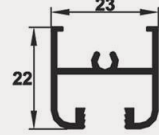
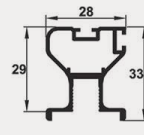
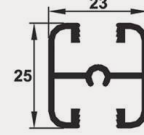
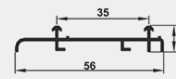
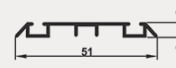
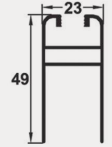
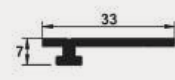
Alüminyum Profiller

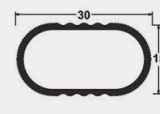
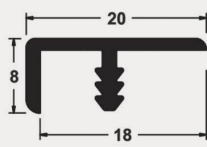
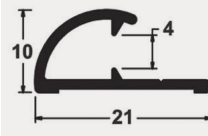
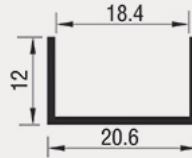
Aluminium Profiles

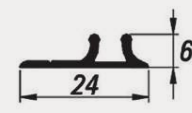

Alüminyum Profiller

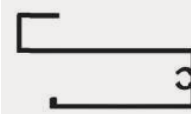
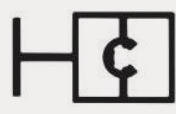
ALUMINIUM PROFILES

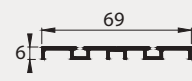
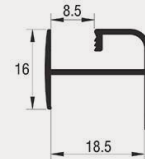
| | | | | | |
|---|---|---|--|---|---|
|  <p>150-2900</p> |  <p>150-2905</p> |  <p>150-2800</p> |  <p>150-2523</p> |  <p>150-2524</p> |  <p>150-2940</p> |
|  <p>150-2600</p> |  <p>150-2500</p> |  <p>150-2710</p> |  <p>150-2711</p> |  <p>150-2810</p> |  <p>150-2811</p> |
|  <p>150-2911</p> |  <p>150-2930</p> |  <p>150-2920</p> |  <p>150-7109</p> |  <p>150-7130</p> |  <p>150-1853</p> |
|  <p>150-1802</p> |  <p>150-1852</p> |  <p>150-1804</p> |  <p>150-1806</p> |  <p>150-1803</p> |  <p>150-1813</p> |
|  <p>150-1807</p> |  <p>150-4405</p> |  <p>150-4420</p> |  <p>150-2413</p> |  <p>150-1327</p> |  <p>150-3615</p> |
|  <p>150-2920</p> |  <p>150-4425</p> |  <p>150-4400</p> |  <p>150-4410</p> |  <p>150-7102</p> |  <p>150-1420</p> |
|  <p>150-2000</p> |  <p>150-2001</p> |  <p>150-2002</p> |  <p>150-2003</p> |  <p>150-2005</p> |  <p>150-2940</p> |

Not : Bu sayfada bulunan profiller stok tutulmamaktadır.

Siparişe özel olarak üretilmektedir.

Alüminyum renk tercihleri için müşteri temsilcilerimizle görüşebilirsiniz.

Minimum sipariş tutarı her profil için 500 kg karşılığı olmalıdır.

Termin süreleri için ayrıca bilgi talep edebilirsiniz.

Note : Profiles are on this page has not keeping stock.

It is produced specially for the orders.

You can contact our customer representatives for special colour alternatives.

Minimum orders quantity should be 500 kg for each profile.

For the production time you can request information from us.

Group 160

160-7000

Pivot Kapı Mekanizması

Pivot Hinge Set



Bu serideki tüm ürünleri incelemek için QR kodu okutabilirsiniz.

You can search the QR code to see all the products in these series.

160-7000

200 KG PIVOT KAPI MEKANİZMASI • PIVOT HINGE SET

Yeni Ürün
New Product



Bilgi / Information

- Minimum kapı panel kalınlığı 40 mm. olmalıdır.
- Door panel's thickness should be minimum 40 mm.
- Kapı kanatları için tasarlanmış pivot mekanizmasıdır.
- Pivot mechanism designed for door leaves.



160-7000 1 Set İçeriği / 1 Set Includes

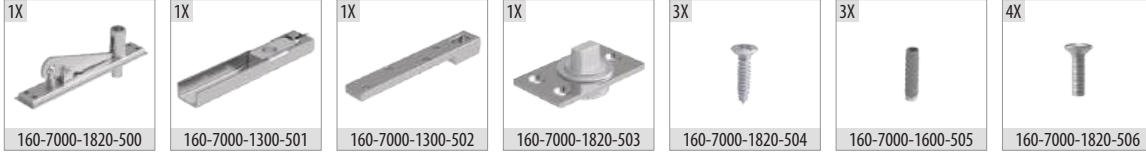

Teknik Detay / Technical Detail

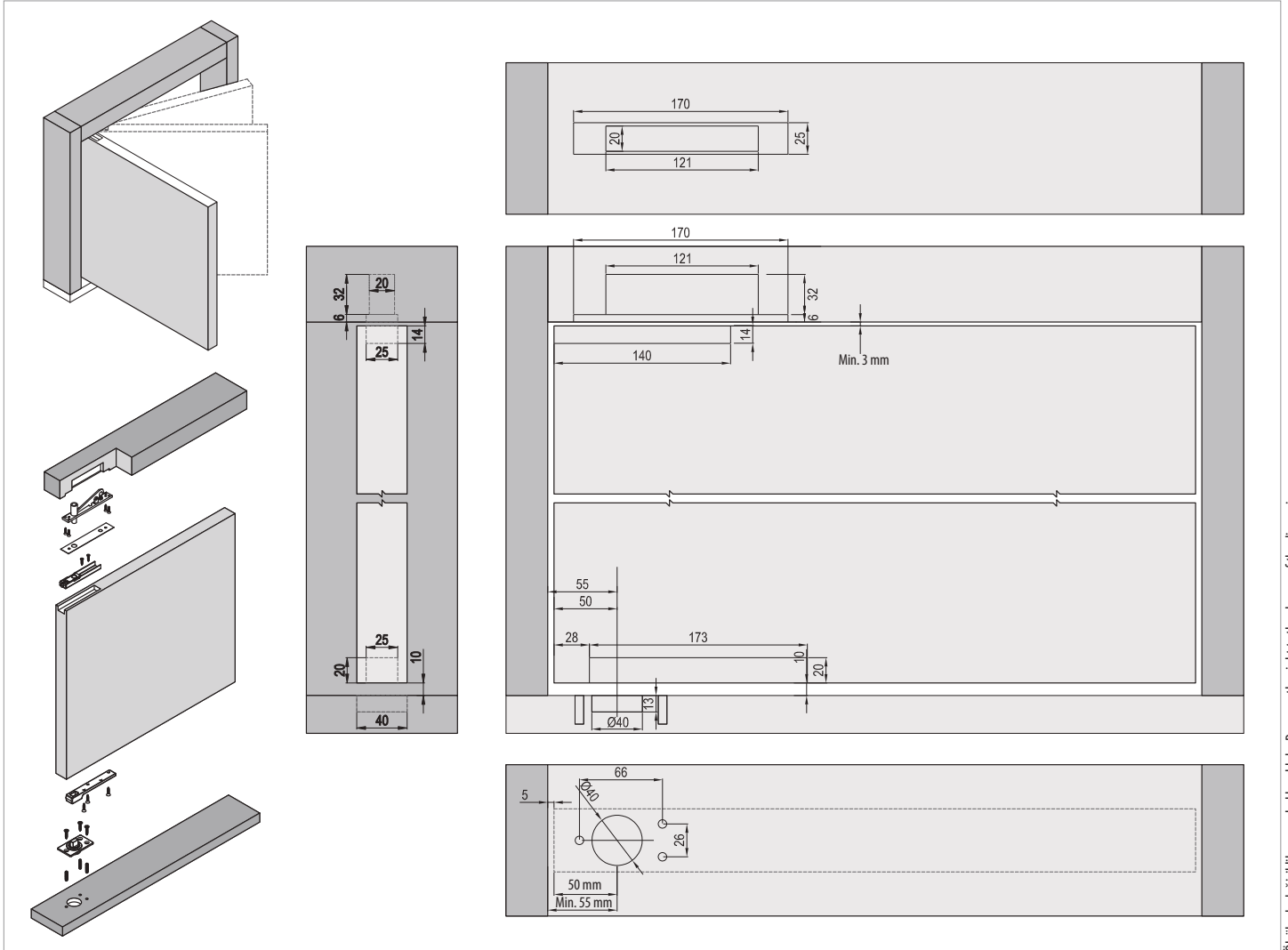

Ölçülerde değişiklik yapma hakkı saklıdır. Reserves the right to the change of the dimensions.

| Kod / Code No | Açıklama / Description | Renk / Colour | Birim / Unit | | |
|---------------|--|-----------------------|--------------|----|-----|
| 160-7000-1820 | Pivot Kapı Mekanizması / Pivot Hinge Set | Galvaniz / Galvanized | 1 Set | 12 | 120 |

SETBOX

PAKETLEME • PACKAGING



Mekanizma ve Profiller aynı ambalaj içerisinde bulunur.
Mechanism and Profiles are in the same package.



Özel dizayn edilmiş straforlar ile dayanıklılık sağlanır.
Durability is provided with specially designed styrofoam.



Perakende satışlar için şık kutu görünümü sunar.
Offers a stylish box view for retail sales.



Malzeme tanımlama etiketi ile izlenebilirlik sağlanır.
Provides traceability with material identification label.



Pratik depolama ve stok kolaylığı sağlar.
Provides practical storage and stock convenience.



Kolay ulaşılabilirlik ve ergonomik taşıma sağlar.
Provides easy accessibility and ergonomic transport.

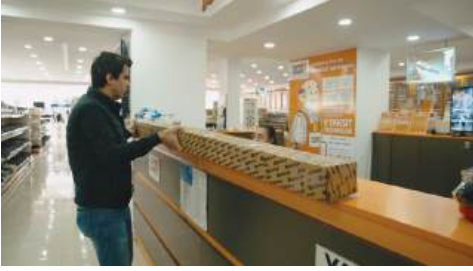

Perakende satışlarda kolaylık sağlar.
It provides convenience in retail sales.



QR kod ile stok hatalarını önler.
Prevents inventory errors with QR code.



Lojistik esnasında hasar ve deformasyonları önler.
Prevents damage and deformations during logistics.



Dayanıklı ambalaj ve hasarsız ürün imkanı sunar.
It offers durable packaging and undamaged product.



Eksiksiz ürün ve montaj kolaylığı sağlar.
Provides complete product and ease of assembly.



E-ticaret imkanı sunar.
Offers e-commerce opportunity.



SETBOX

PAKETLEME • PACKAGING

STANDART PAKETLEME / STANDARD PACKAGING



Standart Sevkiyat Düzenimiz ;

Mekanizma ve ray profilleri, ürüne göre değişen bağ ve koli adetlerinde müşterilerimize sevk edilmektedir.

Standard shipment process ;

Mechanism and rail profiles are packaging and shipping to our customers in changing laps and carton ties and parcels various according to the product.

SETBOX PAKETLEME / SETBOX PACKAGING



Değerli İş Ortağımız ;

Sizlere yeni hizmetimiz SETBOX'ı tanıtmak istiyoruz. Paketleme ve sevkiyat süreçlerinize hız katacağını düşündüğümüz SETBOX sistemi, tek paket içerisinde 1 dolaplık ürünü içermektedir.

SETBOX Paketleme ;

Sürme sistemler için düşünülmüş bu paketleme modelinde, ray profilleri ve mekanizma tek karton ambalaj içerisinde, köpüklerle desteklenmiş olarak 1 set halinde sevk edilmektedir.

Kısaca ; Dolap için 1 setbox içerisinde ; 2 kapak mekanizma + üst ray + alt ray bulunmaktadır.

Neden SETBOX ;

- Bildiğiniz gibi sürgü sistemleri çok bileşenli ürünlerdir. Tek paketleme sayesinde hatasız ve noksansız sevkiyat gerçekleştirilebilir.
- Depolama açısından kolaylık sağlar.
- Değişken ve benzer ray profillerindeki stok karışıklığını önler. Stoklama maliyetlerinizi düşürür.
- Sevkiyat hazırlık sürenizi kısaltır.
- Ürünlerinizi koli ve köpük ambalajı sayesinde daha uzun süreli muhafaza edebilir ve dış darbelerle göre koruyabilirsiniz.
- İnternet üzerinden E-satış yapan firmalar için sevkiyat kolaylığı sağlar.

Detay Bilgiler ;

- Farklı boy ve ürün seçenekleri sebebiyle ürünler siparişe özel paketlenmektedir.
- Stokta hazır ürün bulunmamaktadır.
- Ray boyları 2 mt , 2.5 mt, 3 mt olarak uygulanabilir.
- Kapılarda 1 kapı sistemi ve üst ray paketlenir. İstenirse alın kapama profili paket içerisine ilave edilebilir.
- Setbox sistemi ürün fiyatı üzerine paket maliyeti eklenerek sunulur.

Ürüne özel minimum paketleme miktarı ve fiyat teklifi için müşteri temsilciniz ile temasa geçebilirsiniz.

Dear Business Partner ;

We would like to introduce our new service SETBOX. SETBOX system which we think will add speed to your packaging and shipment process, includes 1 set sliding systems product in one package

SETBOX Packaging ;

In this packaging model for sliding systems , will be shipping 1 set mechanism with rail profiles and inside one carton package and supporting with foam.

Shortly; For wardrobe 1 setbox including ; 2 door mechanism + Top rail + bottom rail

Why SETBOX ;

- As you know, sliding systems are multi-component products
- Easy to storage
- Its prevent to stock confusing for similar and variable profiles. It will reduce of your stocking cost
- Will be positive effect and will be shorten to your shipment time
- You can protect your products for longer periods of time and protect them against to external damage because of carton and foam packaging
- Setbox product give advantage for shipment in online sales

Detailed Informations ;

- The orders can be make special packaging because of different size product and mechanism
- There is no ready product in our stock
- Rail size can be apply 2 mt , 2.5 mt , 3 mt
- For door , 1 door mechanism and Top rail packaging together. If need Closure Profile can be add inside the setbox
- Setbox system product included packaging cost.

You can contact your customer representative for special product minimum specific packaging and price offer.



Çalışma Koşulları

WORKING CONDITIONS

■ Genel Bilgiler

- Ürünlerimiz; patentli, faydalı model ve endüstriyel tasarım tescil belgelidir.
- Fiyatlarımıza KDV dahil değildir.
- ALBATUR önceden haber vermeksizin fiyat ve satış şartlarını değiştirme hakkını saklı tutar.
- Her yeni fiyat listesi bir öncekini geçersiz kılar.
- Siparişini teyid ederek kesinleşirmiş müşterimiz, çalışma koşullarımızı kabul etmiş sayılır.
- Bu fiyat listesinde oluşabilecek tipografik hatalardan firmamız sorumlu değildir.
- ALBATUR önceden haber vermeksizin ürünlerinde dizayn, renk ve hammadde özelliklerini değiştirme hakkını saklı tutar.
- Ürün broşürümüzde, albaturas.com web sitemizde ve kataloglarda verilen teknik ölçüler tavsiye niteliğinde olup, ür-ge sonrasında değişkenlik gösterebilir.
- ALBATUR 'un yazılı izni olmadan katalog ürünlerine ait herhangi bir görüntü kopyalanamaz veya kullanılamaz.
- Ürün paketlemelerinde koli, bağ, palet ölçü ve miktarlarını değiştirme hakkımız saklıdır.
- Firmamız sistemin bir parçası olan ürünlere ilişkin teklî satış yapmama hakkına sahiptir.
- Ödemesi alınmamış siparişler için sevk günündeki fiyatlar geçerlidir.

■ Sipariş Alış Düzeni ve Sevkiyat Düzeni

- Siparişler, yazılı olarak mail veya fax yoluyla firmamıza ulaştırmalı ve teyid almalıdır. Aksi durumda oluşabilecek zarar ve gecikmeden firmamız sorumlu değildir.
- Koli, kutu ve paketleme adetlerine uygun olarak siparişler verilmelidir. Aksi durumda gelen siparişler bağ ve koliye tamamlanmaktadır.
- Stokta bulunmayan ürünler için hammadde tedariki yapılır ve üretim planına alınır.
- Özel siparişlerde ödeme alındıktan sonra üretim yapılır.
- Özel siparişlerde teknik detaylar, renk ve ölçü tam olmalıdır. ALBATUR'dan kaynaklanabilecek kusur dışında iade kabul edilmez.
- Siparişler ödeme önceliği ve sipariş tarihi dikkate alınarak sevk edilir.

■ Ödeme Düzeni

- Satışlarımız kredi kartı, havale veya DBS Sistemiyle ile tahsil edilir.
- Ödemesi alınmayan siparişler sevk edilemez.
- Karşılıksız çeklerin ödemesi 7 günü geçtiği takdirde aylık %3 finansman farkı uygulanır.
- Tüm siparişlerde sipariş bedelinin ödenmesi öncelikli edim olup, sipariş miktarının tümünün veya bir kısmının teslim edilmediği gerekçesi ile ödeme yapmaktan imtina edilemez.
- Siparişlerin sevk edilen tutarı kadar tahsilat yapılır. Sipariş miktarının tamamlanması istenilerek ödemeler şarta bağlanmaz.
- Siparişlerde; ALBATUR kataloğundaki sipariş kodu, varsa rengi, ölçüleri eksiksiz ve tam olmalıdır.

■ Nakliye Düzeni

- Ürünlerin teslim yeri Bursa'daki üretim tesisleridir.
- Müşteri ile karşılıklı mutabık kalınan kargo veya nakliye firmalarına verilmiş mallar müşteriye teslim edilmiş sayılır.
- Siparişlerin, nakliye bedeli ve sorumluluğu müşteriye aittir. Nakliye sırasında doğacak aksaklıklardan ALBATUR sorumlu tutulamaz.
- Müşteri tarafından nakliye şirketi belirtilmediği takdirde, anlaşmalı olduğumuz nakliye firmaları ile sevkiyat yapılmaktadır.
- İstenildiği takdirde ürünler müşteri adına bedeli mukabili sigorta ettirilebilir.
- Müşterimiz, ürünlerini nakliye şirketinden teslim alırken eksik veya hasar durumunu mutlaka kontrol etmelidir. Eğer bir aksaklık var ise nakliye görevlisine o anda tutanak tutturmalıdır. Teslimat fişi imzalandıktan sonra nakliye şirketleri hasar tazmini yapmamaktadır. Müşteri, hasarını nakliye şirketinden talep etmelidir. Tutanağı düzenlenmiş eksik veya hasarlı ürün teslimlerindeki sigorta konularında gerekli bilgilendirme, talep edilmesi durumunda firmamızdan alınabilir.

■ İade Düzeni

- İmalat hatalı ürünler ALBATUR'a bildirilmeli ve onayı alınarak 15 gün içinde iade edilmelidir.
İade edilmeyen ürünler tekrar geri alınmaz ve değiştirilemez.
İade edilecek ürünler ALBATUR'un anlaşmalı kargo veya nakliye firmaları ile yapılmalıdır.
- Sistem ürünlerimizin tüm parçaları firmamızdan temin edilmeyen ürünlerde yaşanabilecek aksaklıklardan firmamız sorumlu değildir.
- Siparişe özel üretilen ürünler iade alınmaz.
- Ürün modeli, dizaynı değişmiş veya listeden çıkarılmış ürünler iade alınmaz.
- İade gönderilmeden önce firmamızdan iade onayı alınmalıdır.
Onay alınmayan ve önceden bilgisi verilmeden gönderilen iade ürünlerin firmamızca giriş kabulü yapılmaz.

Unit 1 - Kullanım Şekli - Category of use No grade identified for these products

Unit 2 - Dayanıklılık (Çalışma/Tur Süreleri) - Durability / Durability is measured by the number of openings (cycles) performed by the gear under standard test conditions. All parts must remain in serviceable condition throughout the test and no adjustment is allowed. Fittings are required to pass the Initial Friction Test (Unit 9) both before and after the durability test. The six grades are :

| | | | | | |
|------------------------|------------------------|-------------------------|-------------------------|-------------------------|--------------------------|
| grade 1 : 2 500 cycles | grade 2 : 5 000 cycles | grade 3 : 10 000 cycles | grade 4 : 25 000 cycles | grade 5 : 50 000 cycles | grade 6 : 100 000 cycles |
|------------------------|------------------------|-------------------------|-------------------------|-------------------------|--------------------------|

Unit 3 - Kapı Ağırlığı - Door Weight / Four grades are identified : The four grades are :

| | | |
|-----------------------|-----------------------------|--------------------------------|
| grade 1 : up to 50 kg | grade 2 : from 51 to 100 kg | grade 3 : from 101kg to 330 kg |
|-----------------------|-----------------------------|--------------------------------|

Unit 4 - Yangın Direnci - Fire Resistance / Two grades of fire resistance are identified :

| | |
|---|--|
| grade 0 :not approved for use on fire door assemblies | grade 1 : suitable for use on fire door assemblies |
|---|--|

Unit 5 - Emniyet -Safety / No requirements

Unit 6 - Korozyon Dayanımı - Corrosion resistance - Five possible grades are identified, clasified in accordance with EN 1670 , Grade 0 also applies to products for which a defined corrosion resistance is not relevant and to those that have not been tested

| | | | | |
|--|--------------------------|-------------------------------|---------------------------|--------------------------------|
| grade 0 : no defined corosion resistance | grade 1 : low resistance | grade 2 : moderate resistance | grade 3 : high resistance | grade 4 : very high resistance |
|--|--------------------------|-------------------------------|---------------------------|--------------------------------|

Unit 7 - Güvenlik - Security / No requirements

Unit 8 - Katagori - Category of door / Three types of door are covered by the standard :

| | | |
|---------------------------------|--------------------------------|----------------------------------|
| grade 1 : straight sliding door | grade 2 : sliding/folding door | grade 3 : multipanel foding door |
|---------------------------------|--------------------------------|----------------------------------|

Unit 9 - İlk Kalkış Momenti - Initial Friction / This is the measurement of amount of force required to start the movement of door .

The grade allocated is variabble depending upon the weight of the door :

| Weight | 0-50 kg | 51-100 kg | 101-330 kg | over 330 kg |
|---------|---------|-----------|------------|-------------|
| grade 1 | 50 N | 80 N | 100 N | 5 %* |
| grade 2 | 40 N | 60 N | 5 %* | 4 %* |
| grade 3 | 30 N | 40 N | 4 %* | 3 %* |

- Albatür Sürgü Sistemleri EN 1527 standartlarına uygun olarak test edilmiştir.
- Albatür Sliding Sytems have been tested in according with the standart of EN 1527 test requirements.

| Properties Product Index | Unit 1 | Unit 2 | Unit 3 | Unit 4 | Unit 5 | Unit 6 | Unit 7 | Unit 8 | Unit 9 |
|--------------------------|--------|-------------------------|-----------------------|--------|--------|--------|--------|-------------|---------|
| 101 G01 | - | Grade 4 (25 000 cycles) | Grade 1 (up to 50 kg) | 0 | - | 0 | - | Grade 1 | Grade 3 |
| 102 G01 | - | Grade 5 (50 000 cycles) | Grade 2 (51-100 kg) | 0 | - | 0 | - | Grade 1 | Grade 2 |
| 103 G01 | - | Grade 5 (50 000 cycles) | Grade 2 (51-100 kg) | 0 | - | 0 | - | Grade 1 | Grade 3 |
| 104 G01 | - | Grade 4 (25 000 cycles) | Grade 1 (up to 50 kg) | 0 | - | 0 | - | Grade 1 | Grade 3 |
| 105 G01 | - | Grade 5 (50 000 cycles) | Grade 1 (up to 50 kg) | 0 | - | 0 | - | Grade 1 | Grade 3 |
| 108 G01 | - | Grade 5 (50 000 cycles) | Grade 1 (up to 50 kg) | 0 | - | 0 | - | Grade 1 | Grade 3 |
| 109 G01 | - | Grade 5 (50 000 cycles) | Grade 1 (up to 50 kg) | 0 | - | 0 | - | Grade 1 | Grade 3 |
| 110 G01 | - | Grade 4 (25 000 cycles) | Grade 1 (up to 50 kg) | 0 | - | 0 | - | Grade 1 | Grade 3 |
| 117 G01 | - | Grade 5 (50 000 cycles) | Grade 1 (up to 50 kg) | 0 | - | 0 | - | Grade 1 | - |
| 118 G01 | - | - | Grade 2 (51-100 kg) | 1 | - | 0 | - | Grade 1-2-3 | - |
| 120 G01 | - | Grade 5 (50 000 cycles) | Grade 2 (51-100 kg) | 0 | - | 0 | - | Grade 1 | Grade 1 |
| 121 G01 | - | Grade 5 (50 000 cycles) | Grade 2 (51-100 kg) | 0 | - | 0 | - | Grade 1 | Grade 1 |
| 122 G01 | - | Grade 4 (25 000 cycles) | Grade 2 (51-100 kg) | 0 | - | 0 | - | Grade 3 | Grade 3 |
| 123 G01 | - | Grade 5 (50 000 cycles) | Grade 2 (51-100 kg) | 0 | - | 0 | - | Grade 1 | Grade 1 |
| 124 G01 | - | Grade 5 (50 000 cycles) | Grade 2 (51-100 kg) | 0 | - | 0 | - | Grade 1 | Grade 1 |

Stand

ÜRÜN TEŞHİR STANDLARI • PRODUCT DISPLAY STANDS

■ 190-0032 • DUVAR TİPİ BÜYÜK STAND • WALL MOUNT STAND



■ Teknik Detay / Technical Detail

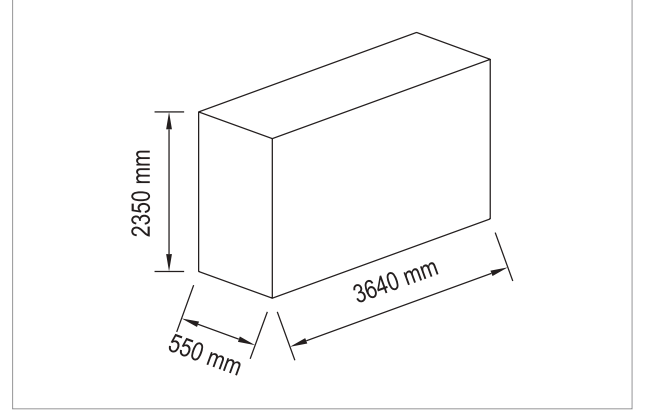

■ 190-0027 • PRATİK STAND • PRACTICAL STAND



■ Teknik Detay / Technical Detail

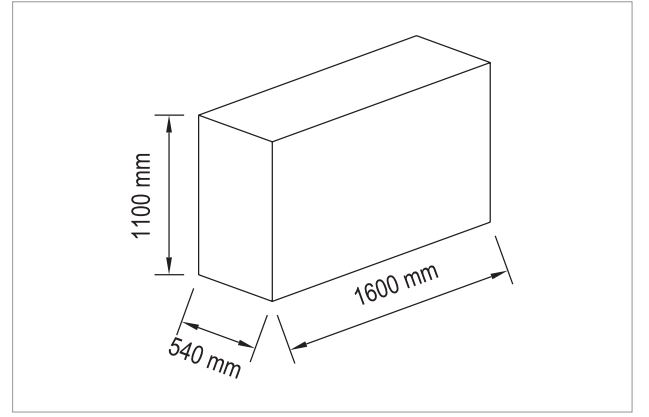

■ 190-0035 • ÜRÜN STAND • PRODUCT STAND



■ Teknik Detay / Technical Detail

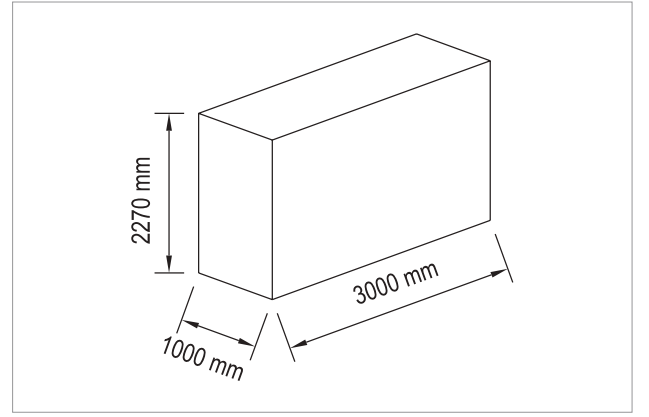

■ 190-0035 • DUVAR TİPİ BÜYÜK STAND • WALL MOUNT STAND



■ Teknik Detay / Technical Detail

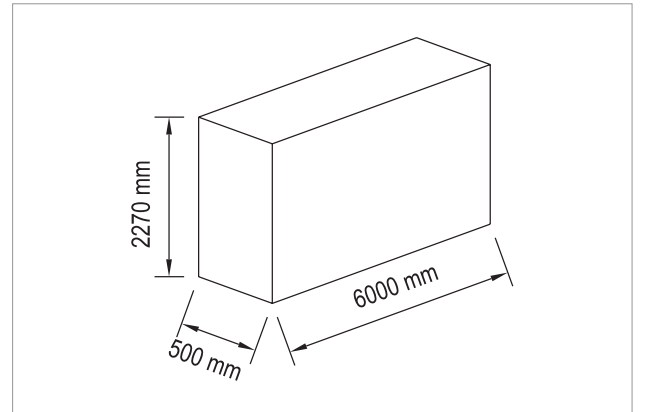

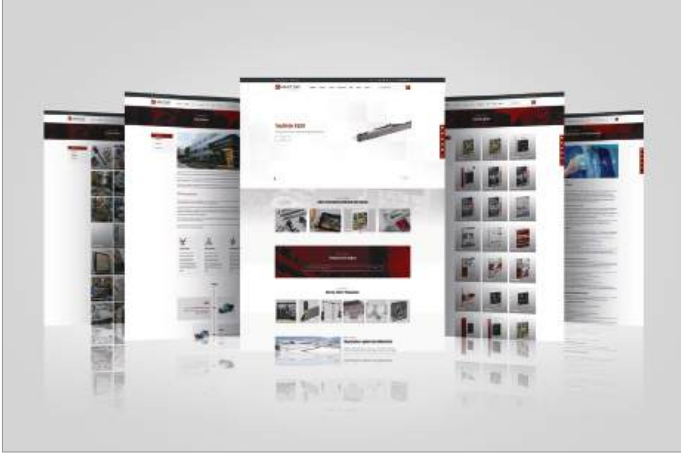

Sürekli güncellenen web sitemizde, ürünlerimizle ilgili ayrıntılı teknik bilgilere ulaşabilir, ürünlerimizin montaj videolarını izleyebilirsiniz. Ürün broşürümüzü inceleyebilir, güncel yeni ürün ve haberleri takip edebilirsiniz.

In our constantly updated website, you can reach more detailed technical information and you can watch installations videos of our products. You can see our product brochure and you can follow new products and news.

■ albaturas.com



Ürünlerimizin kolay ve rahat kurulumunu sağlayabilmek için Albatur olarak montaj videoları hazırlıyoruz. Bu sayede dünyanın farklı köşelerindeki uygulayıcı profesyonellerimize ürünümüzü daha hızlı ve etkin bir şekilde tanıtmaya imkanı elde ediyoruz.

3D montaj videolarımıza
www.albaturas.com
www.youtube.com/albaturas,
vimeo.com/albaturas,
facebook sayfamızdan ulaşabilirsiniz.

In order to provide easy and pratic installation of our products, Albatur company prepares installation videos.In this way, we have the opportunity to introduce our product to our application professionals in different corners of the world faster and more effectively.

You can reach our 3D montage videos from our website
www.albaturas.com
www.youtube.com/albaturas,
vimeo.com/albaturas,
facebook page.

■ youtube.com/albaturas



Önemli Notlar

IMPORTANT NOTES

1. Sürgü Sistem mekanizmaları ve üretimini gerçekleştirdiğimiz tüm Albatür markalı ürünler sistem bileşenleri ile birlikte tasarlanmaktadır. Ürünlerimizde müşteri memnuniyetinin üst seviyede karşılanması için, sürgü sistem ve diğer üretimini gerçekleştirdiğimiz ürünlerin set halinde ALBATÜR markalı olarak kullanılmasını tavsiye ederiz.
2. Sistem elemanlarının "Muadil" ürünler kullanılarak montajlanması durumunda karşılaşılabilecek sorunlardan firmamız sorumlu değildir.
3. Sürgü sistemlerinde her kapak için belirlenmiş taşıma ağırlıklarının aşılmaması önemlidir. Sistemin taşıma ağırlığından fazla yük yüklenmesi sürgü sisteminize zarar verebilir.
4. Sürme sistemlerin stabil çalışması ve ürünlerinizin uzun ömürlü kullanımı için dolabınızın terazide olması önemlidir. Sürgü sistemler hassas ölçülerde çalışmaktadır. Kurulum esnasında bu konuda hassasiyet gösterilmesini tavsiye ederiz.
5. Dolaplarınızın üretimi ve montajı esnasında sürgü sistem teker gruplarının darbeye maruz kalmaması çok önemlidir. Aksi halde teker yüzeyinde veya ray profilleri üzerindeki deformasyonlar kullanıcı memnuniyetini azaltabilir.
6. Teker sistemi ray profiline takılmadan önce, çapak ve benzeri yüzey kirlerinin temizlenmesi ve silinerek montaj edilmesi tavsiye edilir. Aksi durumda mekanizma üzerindeki yabancı malzemeler ray profil yüzeyine zarar verebilir.
7. Ray profillerinin kanal aralarına girebilecek toz vs yabancı cisimler elektrikli süpürge yardımıyla veya kuru bez ile temizlenmesi tavsiye edilir. Temizlenmemesi durumunda bu kalıntılar tekerlek yüzeyine zarar verebilir.
8. Sürgü sistemlerinde en sık karşılaşılan çalışma problemi, firmamıza ait ürünün hatalı olmasından kaynaklanmayan kapaklarda kullanılan doğal ahşap malzemelerin evsafından ve dış etkenlerden kaynaklı olarak değişim göstermesi ve kapakların birbirine temas etmesidir. Bu türden problemleri en başından engellemek için sürme kapaklarınızda kapak gergi sistemleri kullanmanızı tavsiye ederiz.
9. Yavaşlatıcı mekanizmalar ve entegre çalışan yavaşlatıcılı sürgü sistem mekanizmalarının oda sıcaklığında muhafaza edilmesi tavsiye edilir. Piston gövdelerinin aşırı soğuk veya sıcakta maruz kalması ürün performansını olumsuz etkiler.
10. Ürünlerimizin montajında, Yavaşlatıcı sistemlerin montaj öncesinde kurulması önemle tavsiye edilir. Kurulmadan montaj edilmesi durumunda yavaşlatıcıların aktivatör yakalama dili zarar görebilir. Bu sebepten montaj esnasında zarar gören ürünler garanti kapsamı dışındadır.
11. Sürme sistemlerinde harici ve entegre olarak kullanılan yavaşlatıcı mekanizmaların montaj talimatına uygun gerçekleştirilen aktivatör montajı, sistemin sağlıklı ve sorunsuz çalışması için önemlidir. Web sitemizde bulunan teknik dokümanlarımızdan ve ürün kurulum videolarımızdan, tercih ettiğiniz Albatür markalı ürünler için destek alabilirsiniz.
12. Metal TV altlıklarında ürünün taşıma kapasitesinin üzerinde yük yüklenmemesi gerekmektedir. Fazla yük ürünün çalışma prensibine zarar verebilir.
13. Tüm ürünlerimizde montaj talimatına mutlaka uyulması gerekmektedir.
14. Ürünlerimizin montajı esnasında uygulanan yanlış yöntemlerden dolayı yaşanacak hatalardan firmamız sorumlu değildir. Ürünlerimizin kurulumu esnasında dikkat edilmesi gereken hususlar web sitemizde bulunan teknik doküman ve videolarda mevcuttur. Kurulumu başlamadan önce ürüne ait video ve dokümanları incelemenizi tavsiye ederiz.
15. Müşteri tarafından talep edilen ve Albatür tarafından özel üretim yapılan ürünler (üretim hatalı olması dışında) iade alınmaz.
16. Ürünlerimizle ilgili yedek parça taleplerinde kalite yönetim sistemimiz gereğince, üründe hata varsa tespit edebilmek ve kalıcı aksiyon alabilmek adına parçaların firmamıza ulaştırılması gerekmektedir. Aksi durumda yeni parçalar fatura edilerek sevk edilir.
17. Ürünlerimizin demontaj yapılarak kullanılması durumunda yaşanabilecek problemlerden firmamız sorumlu değildir.
18. Ürünlerimiz iç mekan yaşam alanları için tasarlandığından bu ortamlarda kullanılması tavsiye edilir. Dış mekânlarda kullanılacak ürünler için satış ekiplerimizle temasa geçebilir ve teknik bilgi talep edebilirsiniz.
19. Albatür ürünleri, sadece önceden boyanmış, boyası tamamen kurumuş zemin ve ortamlarda montaj edilmelidir. Ayrıca önemle bilinmelidir ki; bazı kimyasal temizlik malzemelerinin kullanımı (deterjan, asit, alkol ve çözücüler vb ..) yüzey kaplamalarına ve mekanizmaya zarar verebileceği için kesinlikle tavsiye edilmez.
20. Albatür gerekli gördüğü zamanda ve durumda, önceden haber vermeksizin ürünlerde ölçü, renk, şekil değişikliği yapma hatta modeli tamamen üretimden kaldırma hakkına sahiptir.
21. Bu kataloğun tüm çoğaltma hakları Albatür Endüstri A.Ş.'ne aittir. İzinsiz çoğaltılamaz.
22. Baskıdan kaynaklanan hatalardan Albatür Endüstri A.Ş. sorumlu değildir.
23. Resimler örnek görüntüler olabilir ve/veya teslim edilecek ürün görselinden farklı bir görünüme sahip olabilir.
24. Kataloğumuzda ve web sayfamızda verilen teknik tanımlar, ölçüler ve çizimler bağlayıcı değildir. Önerilen kurulum ölçüleridir. Albatür ürün özelliklerinde haber vermeden değişiklik yapılabilir.
25. Ürünlerimiz hakkında ürün detaylarına ve teknik çizimlere www.albaturas.com daki ürün sayfalarımızdan ulaşabilirsiniz.
26. Katalog sayfalarımızdaki qr-code 'ları akıllı cihazlar ile tarayabilir ve web üzerindeki ürün sayfasına, teknik çizimlere ve videolara ulaşabilirsiniz.

Important Notes

ÖNEMLİ NOTLAR

1. Sliding System mechanisms and all Albatur branded products that we produce are designed together with system components. For the keep customer satisfaction at the highest level in our products, we recommend that the sliding system and other products what we manufacturing be used as a set with Albatur brand
2. If the system fittings are assembled using «equivalent» products, our company is not responsible for the problems that may occur in this case
3. In sliding systems, it is important not to overlap the specified carrying weights for each door. Loading more than the carrying weight on the system can be damage your sliding system.
4. For the stable and well working of your sliding systems; its important to make good balance of your wardrobe. Sliding systems are working with sensitive dimensions. We recommend paying attention to this issue during installation.
5. It is very important that the sliding system wheels group are not exposed to impact during the production and installation of your cabinets. Otherwise, deformations on the wheels surface or rail profiles can decrease user satisfaction.
6. Before the assembly the wheels system on the rails, recommended to clean the burrs and dirt from the surface. Otherwise other foreign materials can be damage on the profile surface
7. It is recommended to clean rail profiles with a vacuum cleaner or duster for dust etc. objects that may get into between the channels. If not cleaned well, the residues may damage your wheels surface.
8. The most common working problem in sliding systems is that the natural wood materials used in the covers, which are not caused by the faulty product of our company, change due to the quality and external factors, and the covers come into touch with each other. In order to prevent such problems from the beginning, we recommend using door tensioning systems in your sliding doors.
9. It is recommended to keep all kind of the soft closer system mechanisms at room temperature. If leaving the pistons in extreme heat or cold condition ,will be decrease product performance.
10. In the installation of our products, highly recommended to assembly the soft closers before system installation.Soft closers activator's kit can be damage If the install before the assembly. For this reason, damaged products during assembly are out of warranty.
11. Activator installation performed in accordance with the installation instructions of soft closer mechanisms used externally and integrally in sliding systems is important for healthy and trouble-free use of the system. You can get support for your preferred Albatur branded products from our technical prospectus and product installation videos on our website.
12. In the Metal Tv turnable system , should not be load more than carrying capacity. Overload can be damage working principle of the products.
13. Installation instructions must be followed in all our products.
14. Our company is not responsible for the mistakes that may occur due to the wrong methods application during the assembly of our products. Technical documents and related product assembly videos are available in on our website regarding the points that considered during the installation of our products.
15. Special products produced by Albatur with customer request are not returned.(Except for a production faulty)
16. In accordance with our quality management system for the spare part requests related to our products, the fault parts must be delivered to our company in order to detect if there is a fault in the product and for take permanent action.
17. Our company is not responsible for the problems will be happening if our products are used by disassembly.
18. Our products are designed for indoor living spaces, so its recommended to be used in these areas. Products to use for outdoors, you can contact our sales teams and request technical information.
19. Albatur products should only be installed on pre-painted or completely dried floors and environments. It should be known that; the use of some chemical cleaning materials (detergents, acid, alcohol and solvents etc.) is absolutely not recommended as it can damage surface coatings and mechanism.
20. Albatur reserves the right to change the sizes, colors and shape of the products at any time and in case it deems necessary, or even to remove the model completely from the production.
21. All reproduce of this catalog rights are reserved by Albatur Industry Inc. It can't be reproduced without permission.
22. Albatur Industry Inc. is not responsible for printing mistakes.
23. Pictures are can be sample images and/or may will be differnet view the product from the picture of to be delivered.
24. Technical definitions, dimensions and drawings given in our catalog and on our website are not binding. its recommended installation dimensions. Albatur can make changes in the products specifications without notice.
25. You can reach to detailed information about our products and technical drawings of our products on our website www.albaturas.com
26. You can scan the qr-codes in our catalog pages with your smart devices and access the product page, technical drawings and videos on the website.

Kapak Ağırlığı Hesaplama Tablosu

DOOR WEIGHT CALCULATION TABLE

■ Mdf / Mdf



| (mm) | (kg/m ²) |
|------|----------------------|
| 4 | 3,2 |
| 6 | 4,8 |
| 8 | 6,6 |
| 10 | 8,0 |
| 16 | 11,4 |
| 18 | 14,5 |
| 22 | 17,9 |
| 25 | 20,2 |
| 30 | 23,0 |
| 35 | 28,2 |
| 40 | 32,4 |

■ Sunta / Chipboard



| (mm) | (kg/m ²) |
|------|----------------------|
| 8 | 5,5 |
| 16 | 10,0 |
| 18 | 11,2 |
| 22 | 13,6 |
| 25 | 15,3 |
| 30 | 18,1 |
| 35 | 22,0 |
| 40 | 25,0 |

■ Cam / Glass



| (mm) | (kg/m ²) |
|------|----------------------|
| 4 | 10,0 |
| 5 | 12,5 |
| 6 | 15,0 |
| 8 | 20,0 |
| 10 | 25,0 |
| 12 | 30,5 |

Bu sayfanın içeriği sadece referans içindir.
The content of this page is for reference only.

| | | | |
|--|--|--|---|
|  ALBATUR produces quality |  ALB |  ALB GLOBAL |  Dormech door automation |
|  Québec |  windustop |  SRG |  SETBOX |
| THE Sliding System | TurnTable | Pulltens | Multiline |
| WingSlide | GlassDoor | MultiDoor | BarnDoor |
| Glassline | DoorSlide | TvSlide | Rigel |
| Coplanar | Softline | DoorSync | Underline |
| TopSlide | MasterFold | MagicLift | EasyDoor |
| Ventil ®Plastic | Ventil ®Aluminium | Momentum | Interline |
| Domino | Feet | Master+ |  link+ |

